

FOUR CORNERS POWER PLANT LINED DECANT WATER POND - Periodic Structural Integrity Assessment

Periodic Hazard Potential Classification
Periodic Structural Stability Assessment
Periodic Safety Factor Assessment

October 2021
AECOM Project 60664563

Prepared for:

Arizona Public Service
400 North 5th Street
Phoenix, AZ 85004

Prepared by:

AECOM
7720 North 16th Street, Suite 100
Phoenix, AZ 85020
aecom.com

Table of Contents

1. Introduction	1
2. Methodology	1
3. 2017–2021 Annual Inspection Reports	2
4. 2016 Certification – Review by Section	3
4.1 “1.4 Facility Description”	3
4.2 “2 Hazard Potential Classification”	3
4.3 “3 History of Construction”	3
4.4 “4 Structural Stability Assessment”	3
4.5 “5 Safety Factor Assessment”	4
4.6 “6 Conclusions”	4
5. Recommended Additional Technical Investigations or Evaluations	4
6. Conclusion	4
7. Limitations	4
8. Certification Statement	6

Attachment

Attachment A: AECOM, 2016. *Final Summary Report, Structural Integrity Assessment: Lined Decant Water Pond, Four Corners Power Plant, Fruitland, New Mexico.*
Prepared for: Arizona Public Service, AECOM Job No. 60445844, August 2016.

1. Introduction

This periodic update to the Structural Integrity Assessment for the Lined Decant Water Pond (LDWP) at Four Corners Power Plant operated by Arizona Public Service (APS) has been prepared in accordance with the requirements of Title 40 of the Code of Federal Regulations Part 257 (40 CFR 257) (“the Coal Combustion Residuals [CCR] Rule” or “the Rule”) and the specific requirements within 40 CFR § 257.73 for periodic (every 5 years) assessment regarding structural integrity.

2. Methodology

The methodology used to prepare this 2021 Periodic Assessment of Hazard Potential Classification, Structural Stability Assessment, and Periodic Safety Factor Assessment for the LDWP at the Four Corners Power Plant is for the certifying Qualified Professional Engineer (QPE) to:

- a. Perform a documented review of the 5 years of annual inspection reports since 2016, the most recent of which is:
 - i. APS, 2020. Annual CCR Impoundment and Landfill Inspection Report: Four Corners Power Plant Lined Ash Impoundment, Lined Decant Water Pond, Combined Waste Treatment Pond, and Dry Fly Ash Disposal Area. Generation Engineering, Phoenix, AZ.
- b. Perform a documented review of each major component of the contributing technical information from:
 - i. AECOM, 2016. Final Summary Report, Structural Integrity Assessment: Lined Decant Water Pond, Four Corners Power Plant, Fruitland, New Mexico. Prepared for: Arizona Public Service, AECOM Job No. 60445844, August 2016 (hereafter referred to as the “2016 Report” and incorporated and referenced directly as Attachment A to this document); and
- c. Consider and document whether the 2016 Report and its conclusions:
 - i. Meet the current reporting requirements of the Rule;
 - ii. Reflect the current condition of the structure, as known to the QPE and documented in the annual inspections;
 - iii. Are compromised by any identified issues of concern; and
 - iv. Are consistent with the standard of care of professionals performing similar evaluations in this region of the country; and
- d. Identify any additional analyses, investigations, inspections, and/or repairs that should be completed in order to complete this 2021 Periodic Assessment.

This report documents the results of these considerations, incorporates the 2016 Report as an Appendix, identifies any additional technical investigation or evaluations (if needed), and presents an updated certification by the QPE.

3. 2017–2021 Annual Inspection Reports

Information relevant to the general site conditions and current adequacy and performance of the LDWP embankment and outlet works have been considered. No issues were identified during the annual inspections that would affect the performance of the system and its compliance, as described in the 2016 Report, with the various requirements of the CCR Rule relative to (1) hazard potential classification, (2) structural stability, or (3) safety factor assessment.

Several issues have emerged and been documented in the annual list of “Observed Conditions” over the last five years of reports. The most consistently observed, or significant, conditions are: (1) the pond liner being pulled out of anchor trench in the central portion of the West Embankment; (2) sloughs and rills on the West Embankment slope; and (3) small tears and holes in the geomembrane liner, above the pond water level.

Each of the five annual inspection reports document the same specific, limited location at which the pond liner appeared to have been pulled out from the anchor trench. There is no record that the incidence worsened, nor was corrected, over the reporting period. There is no reason to believe that the capacity of the liner to limit seepage from the pond to the embankment has been compromised. AECOM does not believe that this condition affects the stability or structural integrity of the LDWP embankment.

APS continued a maintenance campaign in 2019 to repair minor sloughs and to fill erosion rills in the West Embankment. Sloughs and rills may continue to appear and need to be repaired periodically; however, the rates and locations do not provide concern relative to the stability or structural integrity of the LDWP embankment.

Small tears and holes in the exposed HDPE geomembrane of the pond liner, above the normal operating pond water level, may be expected to occur after 15-plus years of exposure to ultraviolet radiation. With benefit of a lower, secondary HDPE liner, there is no reason to believe that these small holes or tears could contribute to sufficient short-term seepage to affect the stability or structural integrity of the LDWP embankment.

The Interstitial Water Evacuation pump has failed intermittently during the reporting period. During some outages, sufficient water has leaked through defects in the primary liner to allow the primary liner to float, or “whale back”. The presence of a lower, secondary HDPE liner provides confidence that this occasional condition does not provide concern relative to the stability or structural integrity of the LDWP embankment.

The 2017-2021 Annual Inspection Reports also provide information on minimum and maximum values for various types of geotechnical instrumentation installed within the embankments and foundations. Periodically, deviations or technical issues may be identified that limit or alter readings and these instances are reported in the Annual Inspection Reports. For the LDWP, the

instruments consist of standpipe piezometers and surface settlement monuments. The records, including the SM-7 and SM-9 settlement records, were reviewed and no significant, adverse trends that would cause structural instability or change in safety factor.

4. 2016 Certification – Review by Section

Other than as described in the remainder of this section, the details presented in this section of the 2016 Report adequately represent current conditions and satisfy the requirements of the Rule.

4.1 “1.4 Facility Description”

The LDWP is no longer an operating CCR surface impoundment. APS provided notification, dated April 10, 2021, of its intent to close the LDWP.

The LDWP and Lined Ash Impoundment (LAI) are contiguous and have been operated as a single CCR management unit since original construction in 2003; therefore, there remain two inflows to the LDWP from the LAI that either evaporate in the LDWP or can be pumped back to the Plant. The first flow is a gravity flow from the LAI decant tower, which is the primary means of dewatering the LAI in advance of final closure; the second flow is a pumped flow from an internal toe drain within the LAI that removes entrained water from the LAI.

APS intends to close the LDWP and its content in place by dewatering, then folding in the geosynthetic liner system, filling and/ or regrading to provide an integrated closure contour for the entire LAI/LDWP complex, and, finally, by installing an evapotranspiration soil cover.

4.2 “2 Hazard Potential Classification”

The details presented in this section of the 2016 Report adequately represent current conditions and satisfy the requirements of the Rule.

Based on a review of the information presented in the 2016 Report, the LDWP impoundment currently satisfies the criteria for Significant Hazard Potential classification.

4.3 “3 History of Construction”

The details presented in this section of the 2016 Report adequately represent current conditions and satisfy the requirements of the Rule.

4.4 “4 Structural Stability Assessment”

The details presented in this section of the 2016 Report adequately represent current conditions and satisfy the requirements of the Rule.

AECOM assesses that the design, construction, operation, and maintenance of the LDWP are consistent with recognized and generally accepted good engineering practice for the maximum volume of CCR and CCR wastewater that can be impounded therein.

4.5 “5 Safety Factor Assessment”

The details presented in this section of the 2016 Report adequately represent current conditions and satisfy the requirements of the Rule.

AECOM is not aware of any new information that would warrant reevaluation of any material properties, cross-section configurations, or piezometric conditions of the perimeter embankment.

The calculated factors of safety for the three critical cross sections along the LDWP perimeter embankment exceeded the required minimum values for the long-term, maximum storage pool; the maximum surcharge pool; and the seismic (pseudo-static) loading conditions.

4.6 “6 Conclusions”

The details presented in this section of the 2016 Report adequately represent current conditions and satisfy the requirements of the Rule.

5. Recommended Additional Technical Investigations or Evaluations

None identified and none recommended.

6. Conclusion

The 2016 Report and its conclusions meet the current reporting requirements of the Rule, reflect the current condition of the structure as known to the QPE and documented in the annual inspections, are not compromised by any identified issues of concern, and are consistent with the standard of care of professionals performing similar evaluations in this region of the country.

7. Limitations

This report is for the sole use of APS on this project only and is not to be used for other projects. In the event that conclusions based upon the data presented in this report are made by others, such conclusions are the responsibility of others.

The Periodic Structural Integrity Assessment presented in this report is based on the 2016 Report and relies and incorporates any Limitations expressed in that report.

The Certification of Professional Opinion in this report is limited to the information available to AECOM at the time this Assessment was performed in accordance with current practice and the standard of care. Standard of care is defined as the ordinary diligence exercised by fellow practitioners in this area performing the same services under similar circumstances during the same period. Professional judgments presented herein are primarily based on information from

previous reports that have been assumed to be accurate, knowledge of the site, and partly on our general experience with dam safety evaluations performed on other dams.

No warranty or guarantee, either written or implied, is applicable to this work. The use of the word “certification” and/or “certify” in this document shall be interpreted and construed as a Statement of Professional Opinion and is not and shall not be interpreted or construed as a guarantee, warranty, or legal opinion.

8. Certification Statement

Certification Statement for:

- 40 CFR § 257.73(a)(2)(ii) – Periodic Hazard Potential Classification for an Existing CCR Surface Impoundment
- 40 CFR § 257.73(d)(3) – Periodic Structural Stability Assessment for an Existing CCR Surface Impoundment
- 40 CFR § 257.73(e)(2) – Periodic Safety Factor Assessment for an Existing CCR Surface Impoundment

I, Alexander W. Gourlay, being a Registered Professional Engineer in good standing in the State of New Mexico, do hereby certify, to the best of my knowledge, information, and belief, that the information contained in this certification has been prepared in accordance with the accepted practice of engineering. I certify, for the above-referenced CCR Unit, that the periodic hazard potential classification, periodic structural stability assessment, and periodic safety factor assessment provided in this Periodic Structural Integrity Assessment Report, and referencing the 2016 Report, were conducted in accordance with the requirements of 40 CFR § 257.73.

Alexander W. Gourlay, P.E.
Printed Name

October 11, 2021
Date

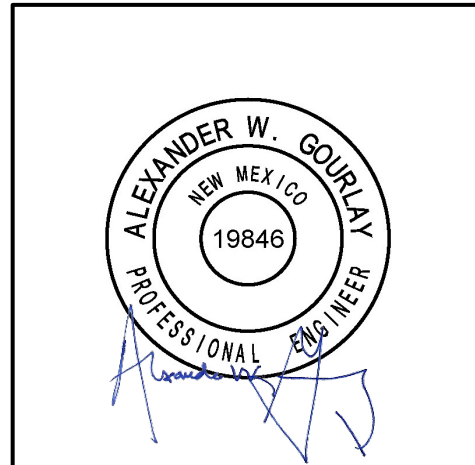

Attachment A:

AECOM, 2016. *Final Summary Report, Structural Integrity Assessment: Lined Decant Water Pond, Four Corners Power Plant, Fruitland, New Mexico*. Prepared for: Arizona Public Service, AECOM Job No. 60445844, August 2016.

ATTACHMENT A

**AECOM, 2016. *Final Summary Report, Structural Integrity Assessment: Lined Decant Water Pond, Four Corners Power Plant, Fruitland, New Mexico.* Prepared for: Arizona Public Service, AECOM
Job No. 60445844, August 2016.**



Submitted to
Arizona Public Service
Generation Engineering
P.O. Box 53999
Phoenix, AZ 85072

Submitted by
AECOM
7720 North 16th Street
Suite 100
Phoenix, AZ 85020
August 26, 2016

Final Summary Report Structural Integrity Assessment Lined Decant Water Pond Four Corners Power Plant Fruitland, New Mexico

Prepared for:
Arizona Public Service

AECOM Job No. 60445844
August 2016

Table of Contents

Certification Statement **1**

1 Introduction **1-1**

1.1 Report Purpose and Description 1-1

1.2 EPA Regulatory Requirements 1-1

1.3 Report Organization 1-2

1.4 Facility Description 1-2

2 Hazard Potential Classification **2-1**

2.1 Methodology and Design Criteria 2-1

2.2 Hazard Potential Classification Results 2-2

3 History of Construction **3-1**

3.1 Methodology 3-1

3.2 LDWP Construction Summary 3-1

4 Structural Stability Assessment **4-1**

4.1 Foundation and Abutments 4-1

4.2 Slope Protection 4-1

4.3 Dike Compaction 4-1

4.4 Slope Vegetation 4-2

4.5 Spillways 4-2

4.6 Hydraulic Structures 4-2

4.7 Downstream Water Body 4-3

4.8 Other Issues 4-3

4.9 Structural Stability Assessment Results 4-3

5 Safety Factor Assessment **5-1**

5.1 Methodology and Design Criteria 5-1

5.2 Critical Cross Section 5-1

5.3 Subsurface Stratigraphy 5-2

5.4 Material Properties 5-2

5.5 Embankment Pore Pressure Distribution 5-3

5.6 Embankment Loading Conditions 5-3

5.7 Safety Factor Assessment Results 5-5

6 Conclusions **6-1**

7 Limitations **7-1**

8 References **8-1**

List of Appendices

- Appendix A. Historic Drawings
- Appendix B. Safety Factor Calculation

List of Tables

Table 3-1. History of Construction for the LDWP	3-2
Table 5-1. Selected Material Parameters – LDWP Safety Factor Assessment	5-3
Table 5-2. Summary of Calculated Safety Factors	5-5

List of Figures

Figure 1-1. Site Vicinity Map	FIG-2
Figure 1-2. Monitored Instrumentation Location Map	FIG-3
Figure 3-1. Site Topography Map	FIG-4
Figure 3-2. Area Capacity Curve	FIG-5
Figure 5-1. Cross Section Locations for Safety Factor Assessment	FIG-6

List of Acronyms

APS	Arizona Public Service
ASTM	American Society for Testing and Materials
CCR	Coal Combustion Residual
CFR	Code of Federal Regulations
EAP	Emergency Action Plan
EL	Elevation
EPA	United States Environmental Protection Agency
FCPP	Four Corners Power Plant
ft	feet
gpm	gallons per minute
HDPE	High Density Polyethylene
HPC	Hazard Potential Classification
LDWP	Lined Decant Water Pond
NMOSE	New Mexico Office of the State Engineer
pcf	pounds per cubic foot
pga	peak horizontal ground acceleration
PMF	Probable Maximum Flood
PMP	probable maximum precipitation
psf	pounds per square foot
RCRA	Resource Conservation and Recovery Act
URS	Upper Retention Sump
USCS	Unified Soil Classification System
USGS	United States Geological Survey

Certification Statement

Certification Statement for:

- 40 CFR § 257.73(a)(2)(ii) – Initial Hazard Potential Classification for an Existing CCR Surface Impoundment
- 40 CFR § 257.73(d)(3) – Initial Structural Stability Assessment for an Existing CCR Surface Impoundment
- 40 CFR § 257.73(e)(2) – Initial Safety Factor Assessment for an Existing CCR Surface Impoundment

CCR Unit: Arizona Public Service Company; Four Corners Power Plant; Lined Decant Water Pond

I, Alexander Gourlay, being a Registered Professional Engineer in good standing in the State of New Mexico, do hereby certify, to the best of my knowledge, information, and belief that the information contained in this certification has been prepared in accordance with the accepted practice of engineering. I certify, for the above-referenced CCR Unit, that the initial hazard potential classification, initial structural stability assessment, and initial safety factor assessment as included in the Structural Integrity Assessment Report dated August 26, 2016 was conducted in accordance with the requirements of 40 CFR § 257.73.

Alexander W. Gourlay, P.E.

Printed Name

August 26, 2016

Date

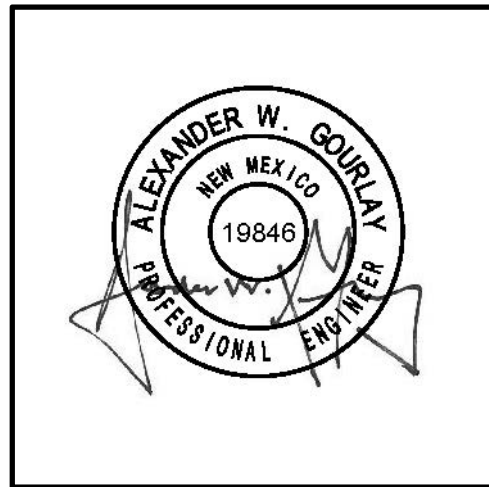

1 Introduction

Arizona Public Service Company (APS) contracted URS Corporation, a wholly owned subsidiary of AECOM, to assist in the initial structural integrity assessment of the existing coal combustion residual (CCR) surface impoundments at the Four Corners Power Plant (FCPP) on the Navajo Nation in Fruitland, New Mexico. Figure 1-1 shows the location of the CCR Impoundments at the FCPP. This Summary Report documents the AECOM structural integrity assessment for the Lined Decant Water Pond (LDWP), New Mexico Office of the State Engineer (NMOSE) Dam No. D-635. Assessments of other CCR Impoundments at the FCPP are presented in separate reports.

1.1 Report Purpose and Description

The purpose of this report is to document the initial structural integrity assessment for the LDWP located at the FCPP. The LDWP is an existing CCR surface impoundment owned and operated by APS that is regulated by the NMOSE. In 2015, the United States Environmental Protection Agency (EPA) finalized Federal Rule (Rule) 40 Code of Federal Regulations (CFR) § 257.73 (EPA, 2015) regulating CCRs under subtitle D of the Resource Conservation and Recovery Act (RCRA). As part of this Rule, owners and operators of existing CCR surface impoundments must complete initial and periodic structural integrity assessments to document whether the CCR unit poses a reasonable probability of adverse effects on health and the environment.

1.2 EPA Regulatory Requirements

Pursuant to Rule 40 CFR § 257.73 (EPA, 2015), each existing CCR surface impoundment must have initial and periodic structural integrity assessments to evaluate whether the CCR unit poses a reasonable probability of adverse effects on health and the environment. The assessment must address the following elements:

- *Periodic Hazard Potential Classification Assessment (40 CFR § 257.73(a)(2))* - Document the hazard potential classification of each CCR unit as either a high hazard, significant hazard, or low hazard potential CCR unit.
- *Emergency Action Plan (EAP) (40 CFR § 257.73(a)(3))* - Prepare and maintain a written EAP for high and significant hazard CCR units. The EAP must be evaluated at least every five years and, if necessary, updated and revised to maintain accurate information of current CCR unit conditions. The evaluation and certification of the EAP is provided in a separate report.

In addition, the following elements must be addressed for CCR units, such as the LDWP, that have a height of five feet (ft) or more and a storage volume of 20 acre-ft or more, or have a height of 20 ft or more:

- *History of Construction (40 CFR § 257.73(c)(1))* - Compile a history of construction of the CCR unit including elements of operation, location, design, monitoring instrumentation, maintenance and repair, and historic structural instabilities.
- *Periodic Structural Stability Assessment (40 CFR § 257.73(d))* - Document whether the design, construction, operation and maintenance of the CCR unit is consistent with recognized and generally accepted good engineering practice for the maximum volume of CCR and CCR wastewater which can be impounded therein.
- *Periodic Safety Factor Assessment (40 CFR § 257.73(e))* - Document whether the calculated factors of safety for each CCR unit achieve minimum safety factors for the critical cross section of the embankment under long-term, maximum storage pool loading conditions, maximum surcharge loading conditions, seismic loading conditions, and post-earthquake loading conditions for dikes constructed of soils susceptible to liquefaction.

Existing CCR surface impoundments, such as the LDWP, are required to have an initial structural integrity assessment within 18 months of publication of the EPA Rule on April 17, 2015 and periodic assessments performed every five years thereafter.

1.3 Report Organization

This Summary Report has been organized into the following sections:

<u>Report Section</u>	<u>Applicable CFR 40 Part 257 Citation</u>
• Section 1 – Introduction	
• Section 2 – Hazard Potential Classification	§ 257.73(a)(2) Periodic hazard classification assessments
• Section 3 – History of Construction	§ 257.73(c)(1) History of construction
• Section 4 – Structural Stability Assessment	§ 257.73(d) Periodic structural stability assessment
• Section 5 – Safety Factor Assessment	§ 257.73(e) Periodic safety factor assessment
• Section 6 – Conclusions	
• Section 7 – Limitations	
• Section 8 – References	
• Figures	
• Appendix A – Historic Drawings	
• Appendix B – Safety Factor Calculation	

1.4 Facility Description

The FCPP is an electric generating station located on the Navajo Nation in Fruitland, San Juan County, New Mexico. The station is operated by APS and owned by a consortium of five utility companies with APS possessing a majority stake. The FCPP consists of two coal-fired electrical generating units, Units 4 and 5. Units 1, 2, and 3 were decommissioned in 2013. The two generating units are cooled by water from Morgan Lake, a man-made reservoir located immediately north of the plant. Four existing CCR surface impoundments are located at the FCPP: the Combined Waste Treatment Pond (CWTP) located immediately east of the plant, the Lined Ash Impoundment (LAI) located about one mile west of the plant, the LDWP located about one and a half miles west of the plant and adjacent to the LAI, and the Upper Retention Sump (URS) located immediately southeast of the plant. CCR generated at the power plant are disposed of at a landfill, the Dry Fly Ash Disposal Area, and the LAI, while the CWTP and LDWP are used as water decant ponds. The URS is an incised surface impoundment receiving storm water from the flue gas desulfurization thickener system. Figure 1-1 shows the location of the CWTP, LAI, and LDWP in relation to the power plant. This assessment evaluates the structural integrity of the LDWP.

The LDWP consists of a reservoir basin formed by a perimeter embankment. It primarily receives decant water from the LAI but also receives smaller amounts of groundwater and storm water. The LDWP acts as a temporary storage reservoir for the collected water before it is pumped back to the plant for reuse.

The LDWP has a total surface area of about 45 acres and a total storage capacity of about 435 acre-ft when at the operational maximum storage pool water level of EL 5209.9 ft (URS, 2012). The impoundment is surrounded on all sides by a perimeter embankment that on the south and west sides are incorporated into pre-existing perimeter embankments of Ash Pond 3. The combined perimeter and Ash Pond 3 embankments are licensed by NMOSE as a dam, NMOSE License No. D-635. Under NMOSE Regulations, the LDWP has been classified as an intermediate sized, significant hazard dam.

The LDWP perimeter embankment is an earthen, zoned embankment dam. Along the northern and eastern sections, the embankment consists of compacted bottom ash with a 15-foot wide layer of compacted clay along the upstream slope. Along the southern and western sections, the embankment consists entirely of compacted clay. The embankment was constructed in 2003 on top of Ash Pond 3, an older ash impoundment no longer in service. The southern and western embankments were incorporated into the pre-existing perimeter embankments of Ash Pond 3. The Ash Pond 3 embankments are also constructed of compacted bottom ash with an upstream layer of compacted clay. The northern and eastern embankments of the LDWP were constructed on existing fly ash deposits of Ash Pond 3. The embankment is approximately 5,488 ft in length with a height of about 16 ft on the north and east sides and about 92 ft on the west and south sides where 76 ft of the height constitutes the underlying Ash Pond 3 embankment. The crest width is 20 ft over the length of the embankment with upstream slopes inclined at two horizontal to one vertical (2H:1V) and downstream slopes inclined at 1.5H:1V; however some vertical sections of the western embankment are steeper with inclinations as great as 1.4H:1V. The top of crest elevation (EL) is 5,216 ft creating about 6.1 ft of freeboard above the maximum storage pool water level of EL 5209.9 ft (URS, 2014). The upstream slope of the perimeter embankment and the entire pond are lined with a geomembrane liner system that prevents erosion of the slopes; the downstream slope is composed of compacted granular material with high frictional strength.

The LDWP embankment is founded on about 40 to 50 ft of hydraulically placed existing fly ash along the northern and eastern sides and weathered shale bedrock along the southern and western sides where the embankment has been incorporated into the pre-existing embankment of Ash Pond 3. To limit seepage into the embankments and underlying fly ash deposits, the LDWP was installed with a dual High Density Polyethylene (HDPE) liner and leak detection/recovery layer that covers the impoundment basin to the embankment crest. The LDWP embankment has no internal drain system, such as toe drains or chimney drains.

The LDWP has no fixed intake or outlet water work structures. Water from the LAI flows to the LDWP through three pipes associated with two inlets. The first inlet consists of two pipes that cross the embankment near the northeast corner of the impoundment. They are connected to a clearwell drop inlet tower installed in the LAI. The primary drain pipe is an eight-inch diameter polyethylene pipe and the secondary pipe is a 16-inch diameter polyethylene drainpipe located above the primary. Both pipes are routed across the top of the embankment and drain into the pond. The second inlet consists of a four-inch diameter pipe that is routed over the embankment crest near the southeast corner of the impoundment. Water collected through a perforated eight-inch diameter HDPE pipe located on the bottom of the LAI pond is pumped through the four-inch pipe into the LDWP. Water levels within the pond are controlled by varying the pump rate out of the pond through a return water line to balance with pond evaporation and inflow for the LAI. The return line pumps water back to the plant for reuse. The outlet is located in the northeast corner of the impoundment and consists of one six-inch diameter HDPE pipe at an invert elevation of EL 5,206 ft. The pipe section within the footprint of the LDWP is double-walled to protect against rupture and subsequent erosion of the embankment. The pump system has a design flow rate of 450 gallons per minute (gpm).

The LDWP was constructed without an overflow spillway channel. To prevent overtopping during the design level storm event, defined as the 72-hour probable maximum precipitation (PMP), the pond was constructed with sufficient depth to fully contain the storm run-on of both the LDWP and the LAI on top of the operational maximum storage pool water level. This water level, defined as the maximum surcharge pool water level, is estimated at EL 5,214.0 ft based on an expected water level rise of 4.1 ft during the probable maximum flood (PMF) (URS, 2014). The surcharge pool water level leaves two ft of freeboard below the embankment crest.

Standpipe piezometers and survey settlement/displacement monument devices are installed at the LDWP to monitor the performance of the embankment. Measurements from the monitoring instruments are reviewed and documented annually as part of the annual inspection. Starting on October 19, 2015, the piezometers and survey monuments are read at intervals not exceeding 30 days per the requirements of 40 CFR § 257.83(a)(1)(iii). The locations of the piezometers and survey monuments are shown on Figure 1-2.

Inspections of the LDWP are performed by a qualified person at intervals not exceeding seven days. The inspections examine the LDWP for actual or potential conditions that could disrupt the operation or safety of the impoundment and documents the results of the inspection in the facility's operating record. In addition, a more detailed annual inspection is performed by a qualified professional engineer. The annual inspection includes a review of available information on the dam including the past year of monitoring data, a field inspection of the dam, abutment, and downstream toe, and documentation of findings and recommendations in a dam safety inspection report. The most recent annual inspection of the LDWP was performed on October 14, 2015 (AECOM & APS, 2016).

2 Hazard Potential Classification

This section summarizes the initial Hazard Potential Classification (HPC) for the LDWP. This initial HPC is intended to meet the requirement for periodic hazard potential classification assessment of existing CCR surface impoundments per Rule 40 CFR § 257.73(a)(2).

2.1 Methodology and Design Criteria

Per the Rule, the hazard potential classification provides an indication of the possible adverse incremental consequences that result from the release of water or stored contents due to failure or mis-operation of the CCR surface impoundment. The classification is based solely on the consequences of failure. As such, it is not dependent of the condition of the embankment or the likelihood of failure. Classifications per the Rule are separate from relevant and/or applicable federal, state or local dam safety regulatory standards, which may also include hazard classification definitions, and are not intended to substitute for other regulatory hazard potential classifications.

Rule 40 CFR § 257.53 defines three hazard potential classifications as follows:

High hazard potential CCR surface impoundment – A diked surface impoundment where failure or mis-operation will probably cause loss of human life.

Significant hazard potential CCR surface impoundment – A diked surface impoundment where failure or mis-operation results in no probable loss of human life, but can cause economic loss, environmental damage, disruption of lifeline facilities, or impact other concerns.

Low hazard potential CCR surface impoundment – A diked surface impoundment where failure or mis-operation results in no probable loss of life and low economic and/or environmental losses. Losses are principally limited to the surface impoundment's owner's property.

The hazard potential of the LDWP was assessed qualitatively, per the above definitions. The qualitative assessment process is generally performed in a step-wise manner by first determining whether the pond could be classified as low hazard potential, based on immediately obvious factors such as proximity to property lines and/or surface water bodies. After determining that a structure does not meet the criteria for a Low Hazard Potential classification, the structure is assessed to determine whether it meets the criteria for High Hazard Potential. The potential for loss of life differentiates between high and significant hazard potential in the Final CCR Rule; therefore, if the Dam does not meet the criteria for high hazard potential, it would be classified as a Significant Hazard Potential structure.

The potential for downstream loss of life is assessed by reviewing land use in areas downstream (to the west) from the Dam, where inundation is likely in the event of a release. A dam break analysis and inundation mapping has been documented for the Lined Ash Impoundment (LAI) (URS, 2009) and was assessed as generally applicable to the LDWP. The inundation was reportedly mapped downstream in the Chaco River to the San Juan River. No habitable structures were reported in the inundation area and the flood outflow passes beneath the Highway N36 Bridge (URS, 2009). United States Geological Survey (USGS) 7.5-Minute Quadrangle topographic map of The Hogback North, NM and associated digital orthoimage data (USGS, 2013) were also used to review downstream areas for existing permanent and temporary land use. Permanent land uses include permanently inhabited dwellings and worksite areas that would likely contain workers on a daily basis (public utilities, power plants, water and sewage treatment plants, private industrial plants, sand and gravel plants, farm operations, fish hatcheries). Temporary land uses include primary roads, established campgrounds, or other recreational areas.

2.2 Hazard Potential Classification Results

Inspection of the LDWP Dam and its immediate surroundings relative to property lines, surface water bodies, and structures that could potentially be impacted by a release indicated that the LDWP Dam does not meet the criteria for a Low Hazard Potential classification based on the proximity to an off-site surface water body (Chaco River).

The Chaco River is approximately 2,500 ft downstream from the LDWP Dam. Except for closed Evaporation Pond No. 1 and closed Evaporation Pond No. 2, the area between the LDWP and The Chaco River is completely unoccupied and undeveloped. No permanent or temporary dwellings, worksites, roads, or other development that would indicate the routine presence of people downstream from the LDWP (off-site) were identified. Therefore, the LDWP Dam does not meet the criteria for a High Hazard Potential classification based on the absence of probable loss of life resulting from failure or mis-operation. Because the LDWP Dam does not meet the criteria for classification as either Low Hazard Potential or High Hazard Potential, it is classified as a Significant Hazard Potential CCR surface impoundment.

3 History of Construction

This section summarizes the history of construction for the LDWP. This information is intended to meet the requirement for compilation of the history of construction for each CCR surface impoundment per Rule 40 CFR § 257.73(c)(1).

3.1 Methodology

AECOM reviewed available documents obtained from APS or in-house resources for information regarding the history of construction for the LDWP. Per the Rule, the compiled history of construction should include, to the extent feasible, the following information:

- Information identifying the CCR Unit, its purpose and the name and address of the owner/operator;
- The location of the CCR unit on the most recent USGS or other topographic map;
- Name and size of the watershed within which the CCR unit is located;
- A description of the physical and engineering properties of the foundation and abutment materials on which the CCR unit was constructed;
- A description of the type, size, and physical and engineering properties of each embankment zone;
- Provide detailed engineering drawings;
- A description of the type, purpose and location of existing instruments;
- Area-capacity curves for the CCR unit;
- A description of spillway and diversion design features;
- Construction specifications and provisions for surveillance, maintenance, and repair of the CCR unit; and
- Any record of knowledge of structural instability.

3.2 LDWP Construction Summary

The history of construction dating back to the original construction that began in 2003 is summarized in Table 3-1 below.

Table 3-1. History of Construction for the LDWP

Item	As-Constructed/ Current	Comments	Reference Document
Name and Address of Owner	Arizona Public Service Company (APS): P.O. Box 53999, Phoenix, Arizona 85072	---	---
State ID No.	D-635	---	NMOSE License to Operate dated February 7, 2008
Size Classification	Intermediate	---	Annual CCR Impoundment and Landfill Inspection Report 2015 (AECOM & APS, 2016)
Hazard Classification	Significant	---	See Section 2.2
Construction Date	2003	---	NMOSE Certificate of Construction dated February 7, 2008
Location on USGS Quadrangle Map	The Hogback North Quadrangle: Sections 34, Township 29 North, Range 16 West	See Figure 3-1	The Hogback North Quadrangle (USGS, 2013)
Statement of Purpose	Storage of LAI decant water prior to recycling back to the plant	---	---
Name of Watershed	---	---	---
Size of Watershed (ac)	191.3	---	<ul style="list-style-type: none"> Includes LAI tributary area Breach and Inundation Study (2009) LAI Engineering Design Report (URS, 2012)
Area Capacity Curve	See Figure 3-2	---	LAI Engineering Design Report (URS, 2012)
Embankment Type	Zoned earth and ash fill dam	---	NMOSE Certificate of Construction dated February 7, 2008
Embankment Maximum Height (ft)	16	---	NMOSE Certificate of Construction dated February 7, 2008
Design Total Freeboard (ft)	6.1 (above maximum operating level, EL 5209.9)	2.8 (above maximum surcharge level, EL 5213.2)	<ul style="list-style-type: none"> NMOSE Certificate of Construction dated February 7, 2008 LAI Engineering Design Report (URS, 2012)
Embankment Length (ft)	5,488	---	NMOSE Certificate of Construction dated February 7, 2008
Embankment Crest Elevation (ft)	5,216	---	NMOSE Certificate of Construction dated February 7, 2008

Item	As-Constructed/ Current	Comments	Reference Document
Embankment Crest Width (ft)	20	---	As-built Drawing No. 150793, Sheets 3 and 4, Revision No. 3 (APS, 2003)
Embankment Slopes	1.4H:1V to 2H:1V (downstream); 2H:1V and 3H:1V (upstream)	---	As-built Drawing No. 150793, Sheets 3 and 4, Revision No. 3 (APS, 2003)
Slope Protection	Double-layer HDPE liner with clay on upstream slope	---	As-built Drawing No. 150793, Sheet 4, Revision No. 3 (APS, 2003)
Maximum Operating Storage Level (ft)	5209.9	Maximum surcharge EL is 5,213.2 as noted on as-built drawings.	<ul style="list-style-type: none"> As-built Drawing No. 150793, Sheet 2 (APS, 2003) LAI Engineering Design Report (URS, 2012)
Storage Capacity (ac-ft)	435	---	NMOSE Certificate of Construction dated February 7, 2008
Surface Area (ac)	45.4	---	As-built Drawing No. 150793, Sheet 1 (APS, 2003)
Material Properties			
Embankment			
Physical Properties	The embankment consists of compacted earth (clay) and ash fill.	---	LAI Engineering Design Report (URS, 2012)
Engineering Properties	<u>Compacted Clay:</u> <ul style="list-style-type: none"> Moist Unit Weight = 125 pounds per cubic foot (pcf) Effective Cohesion = 300 pounds per square foot (psf) Effective Friction Angle = 20° <u>Compacted Bottom Ash:</u> <ul style="list-style-type: none"> Moist Unit Weight = 65 pcf Effective Cohesion = 0 psf Effective Friction Angle = 34° 	---	
Foundation			
Physical Properties	The foundation consists of pre-existing fly ash in Ash Pond No. 3, underlain by bedrock consisting of weathered shale.	---	LAI Engineering Design Report (URS, 2012)

Item	As-Constructed/ Current	Comments	Reference Document
Engineering Properties	<p><u>Fly Ash:</u></p> <ul style="list-style-type: none"> Moist Unit Weight = 90 pcf Effective Cohesion = 0 psf Effective Friction Angle = 28° <p><u>Bedrock (Weathered Shale):</u></p> <ul style="list-style-type: none"> Moist Unit Weight = 120 pcf Effective Cohesion = 500 psf Effective Friction Angle = 30° 	---	
Abutment Conditions			
None. The impoundment is enclosed by embankment.			
Spillway	None	The impoundment has sufficient storage volume above the maximum storage pool water level to store the IDF PMF and maintain at least two ft of freeboard. A pump with a capacity of 540 gallons per minute pumps water back to the power plant.	NMOSE Certificate of Construction dated February 7, 2008
Construction Specifications	---	---	---
Detailed Drawings	See Appendix A for drawings	---	As-built Drawings (APS, 2003)
Existing Instrumentation			
Type and Purpose of Instrumentation	<ul style="list-style-type: none"> Standpipe piezometers for monitoring the phreatic levels in the embankment and foundation. Settlement monuments for monitoring movement of the embankment. 	---	<ul style="list-style-type: none"> As-built Drawing No. 150793, Sheet 7 (APS, 2003) Annual CCR Impoundment and Landfill Inspection Report 2015 (AECOM & APS, 2016)
Location of Instrumentation	<ul style="list-style-type: none"> Open standpipe piezometers located in the embankment. Movement monuments located along the embankment crest. 	See Figure 1-2	<ul style="list-style-type: none"> As-built Drawing No. 150793, Sheet 7 (APS, 2003) Annual CCR Impoundment and Landfill Inspection Report 2015 (AECOM & APS, 2016)

Item	As-Constructed/ Current	Comments	Reference Document
Provisions for Surveillance, Maintenance and Repair	<ul style="list-style-type: none"> • Visual inspections of the dam by a qualified person on a frequency not exceeding seven days. • Visual inspections of the dam conducted annually by a professional engineer. • Phreatic level behavior from piezometric measurements collected on a frequency not exceeding 30 days. • Embankment settlement using movement monuments survey data collected on a frequency not exceeding 30 days. 	---	Annual CCR Impoundment and Landfill Inspection Report 2015 (AECOM & APS, 2016)
Record of Structural Instability	None	---	---

4 Structural Stability Assessment

This section summarizes the structural stability assessment for the LDWP. This information is intended to satisfy the requirement of Rule 40 CFR § 257.73(d).

4.1 Foundation and Abutments

Per the requirements of 40 CFR § 257.73(d)(1)(i), existing CCR impoundments must be assessed for “*Stable foundations and abutments.*”

The LDWP is constructed on top of the Ash Pond 3 impoundment. The west and south embankments are downstream raises of the existing Ash Pond 3 embankments and the north and east embankments are constructed on the old hydraulically deposited fly ash of Ash Pond 3.

The west and south embankments of the LDWP are founded on the pre-existing perimeter embankment of Ash Pond 3. The Ash Pond 3 embankments were constructed primarily with compacted bottom ash with an upstream layer of compacted clay/weathered shale and are founded on native silts, clays, and weathered shale. The native soils and shale, within the embankment footprint, appear to be competent materials based on exploratory borings drilled to bedrock during several Geotechnical Investigations performed for the LDWP and the LAI. Records of the Ash Pond 3 construction were not available for review; however, the LDWP and LAI Geotechnical Investigations show the embankment materials are primarily medium dense, an indication that mechanical compaction methods were used in construction.

The north and east embankments of the LDWP were constructed with similar methods used for the west and south embankments, with exception of the foundation preparation. The north and east embankments are founded on two layers of geogrid with compacted bottom ash below, above, and in between the reinforcement. The layer of reinforced granular fill was constructed to mitigate excessive settlement of the embankment over the soft foundation of previously impounded fly ash.

Review of the measured displacements of the survey monuments at the crest of the LDWP, as presented in the 2015 annual dam inspection report (AECOM & APS, 2016), indicates no significant settlements along the crest of the dam within the year. The relatively small settlement and horizontal movements measured at the LDWP are an indication of stability in the dam foundation.

4.2 Slope Protection

Per the requirements 40 CFR § 257.73(d)(1)(ii), existing CCR impoundments must be assessed for “*Adequate slope protection to protect against surface erosion, wave action, and adverse effects of sudden drawdown.*”

The upstream slopes of the LDWP are lined with a double-layer of HDPE liner with clay, which protects slopes from erosion, wave action, and adverse effects of sudden drawdown. The downstream slopes consist of compacted bottom ash and are not vegetated; however, the granular nature of bottom ash generally allows infiltration in preference to runoff and erosion. Additionally, APS has a program to regularly inspect and repair any significant erosion rills. The 2015 annual dam inspection report (AECOM & APS, 2016) reported that the downstream slopes of the embankments show evidence of minor to significant erosion rilling, presumably caused by rainfall runoff. APS maintains the affected areas by regrading and recompacting eroded areas.

4.3 Dike Compaction

Per the requirements 40 CFR § 257.73(d)(1)(iii), existing CCR impoundments must be assessed for “*Dikes mechanically compacted to a density sufficient to withstand the range of loading conditions in the CCR unit.*”

The LDWP embankment is composed primarily of compacted bottom ash, which has been demonstrated during construction of the LAI to readily compact with various ranges of compaction and hauling equipment. The embankment was constructed by placement of soils in mechanically compacted thin lifts of eight inches or less. Construction control of the compaction process was maintained using a method procedure where the soil preparation, placement, watering, discing (if necessary), and compaction are specified based on the results of testing during earthwork. Quality control testing was performed to check the bottom ash was reaching the desired level of compaction defined as 95 percent of the Standard Proctor dry density (American Society for Testing and Materials D698).

Construction records of the Ash Pond 3 embankment could not be found to indicate the results of the quality control testing. Borings drilled through the west and south embankment crest during the 2003 Geotechnical Investigation recorded Standard Penetration Test (SPT) blow counts (uncorrected) ranging from 9 to 29 blows per foot (bpf) indicating a primarily medium dense relative density with occasional loose layers. During the 2011 Geotechnical Investigation for the 5280 lift of the LAI, the cone penetration test (CPT) soundings performed from the east embankment crest resulted in cone tip resistance ranging from 120 to 250 tons per foot (tsf) within the embankment.

Based on review of the construction records/completion report for similar construction associated with the LAI raises, and geotechnical borings/soundings results, the embankments appear to be constructed with well compacted materials.

4.4 Slope Vegetation

Per the requirements 40 CFR § 257.73(d)(1)(iv), existing CCR impoundments must be assessed for “*Vegetated slopes of dikes and surrounding areas, except for slopes which have an alternate form or forms of slope protection.*” Note that the United States Court of Appeals for the District of Columbia Circuit remanded with vacatur the phrase “*not to exceed a height of six inches above the slope of the dike*” from this subsection of the Rule.

As noted in Section 4.2, the downstream slope which is comprised of compacted bottom ash, are not vegetated. APS has a program of regularly inspection and repair erosion rills. The upstream slope consists of a dual HDPE liner and therefore is excluded from the vegetated slope requirements since it uses an alternate form of slope protection

4.5 Spillways

Per the requirements 40 CFR § 257.73(d)(1)(v), existing CCR impoundment must be assessed for “*A single spillway or a combination of spillways configured as specified in paragraph (d)(1)(v)(A) of this sections. The combined capacity of all spillways must be designed, constructed, operated, and maintained to adequately manage flow during and following the peak discharge from the event specified in paragraph (d)(1)(v)(B) of this section.*”

The LDWP was not constructed with a spillway. The maximum operating level and freeboard allocation for the LDWP has been designed to allow for containment of the full PMF for both the LDWP drainage area (direct precipitation and runoff from the east embankment of the LAI) and the LAI.

Based on the engineering design report for the LAI (URS, 2012) which specifies the water inflow to the LWDP and the most recent inspection report, the LDWP has been designed, constructed, and maintained to adequately contain the flows during and following the peak discharge of the 72-hour PMP event, which exceeds the requirement for the significant hazard rating for this CCR Unit.

4.6 Hydraulic Structures

Per the requirements 40 CFR § 257.73(d)(1)(vi), existing CCR impoundments must be assessed as follows “*Hydraulic structures underlying the base of the CCR unit or passing through the dike of the CCR unit that maintain structural integrity and are free of significant distortion, bedding deficiencies, sedimentation, and debris which may negatively affect the operation of the hydraulic structures.*”

A return line is located in the northeast corner of the impoundment that pumps water back to the plant for reuse. The outlet consists of one six-inch diameter HDPE pipe. The outlet pipe penetrates the LDWP embankment at an invert elevation of EL 5,206 ft. No construction or as-built records could be found to indicate embedment of the pipe in anything other than

compacted earth fill. Recent inspections of the impoundment (AECOM and APS, 2016), found the outlet pipe appeared to be working effectively with no evidence of subsidence or other indication of potential deterioration of the surrounding embankment.

4.7 Downstream Water Body

Per the requirements 40 CFR § 257.73(d)(1)(vii), existing CCR impoundments must be assessed for *“For CCR units with downstream slope which can be inundated by the pool of an adjacent water body, such as a river, stream or lake, downstream slopes that maintain structural stability during low pool of the adjacent water body or sudden drawdown of the adjacent water body.”*

No structural stability deficiencies are presently associated with inundation of the downstream slope of the LDWP by an adjacent body of water since no pool of water, such as a river, stream or lake, is present downstream of the dam which could inundate the downstream slope.

4.8 Other Issues

No deficiencies were identified for the LDWP that could affect the structural stability of the impoundment. The most recent dam inspection (AECOM & APS, 2016) reported observations of minor to significant erosion rills on the downstream slopes. APS reportedly has been maintaining affected areas by regrading and recompacting eroded areas. It is recommended that the program be continued and that rills are repaired if the depth exceeds one foot.

4.9 Structural Stability Assessment Results

AECOM did not identify any structural stability deficiencies that would affect the structural condition of the LDWP CCR Impoundment based on the documents provided and reviewed as part of this assessment. AECOM assesses that the design, construction, operation and maintenance of the CWTP are consistent with recognized and generally accepted good engineering practice for the maximum volume of CCR and CCR wastewater which can be impounded therein.

5 Safety Factor Assessment

This section summarizes the safety factor assessment for the Fly Ash Pond. This assessment is intended to satisfy the requirement of Rule 40 CFR § 257.73(e).

5.1 Methodology and Design Criteria

Slope stability analyses were performed to document minimum factors of safety for loading conditions identified by 40 CFR § 257.73(e) using the software program SLOPE/W (GEO-SLOPE International, 2012). The analyses were performed using Spencer's Method; a limit equilibrium method of slices that satisfies both force and moment equilibrium and incorporates the effects of interslice forces. The analyses incorporate strength and density properties and pore pressure distributions described in Sections 5.4 and 5.5. The slope stability models are presented in Appendix B.

5.2 Critical Cross Section

Safety factors were calculated for three cross sections of the LDWP perimeter embankments selected to represent different embankment geometries, heights, and stratigraphic conditions to provide confidence that the critical cross section was identified. The critical cross section is the cross section that is anticipated to be most susceptible to structural failure for a given loading condition. The critical cross section thus represents a "most-severe" case. Section locations were selected based on variation in the embankment height, presence of cutoff trench/cutoff wall, and stratigraphic conditions. Subsurface soil profiles were developed using as-built drawing set of the LDWP (Appendix A) and boring logs associated with the installation of piezometers P-18 and P-20. The locations of the cross sections along the LDWP are shown in Figure 5-1. The three cross sections analyzed are:

West Embankment (Steepest Upper Section): This cross-section is located just north of the Section D as shown on Figure 5-1 and the as-built section (Appendix A). This section represents the steepest downstream slope inclination for the upper section of the slope, the downstream sloped being benched about mid-height. The embankment is approximately 92 ft high from crest to downstream toe at this location. The upstream slope is inclined at 2.5H:1V. The downstream slope is inclined overall from crest to toe at 2.0H:1V; however, the upper section of the slope above the bench is at 1.5H:1V. The bench is at an approximate elevation of EL 5,168 ft, 50 ft below the crest. The embankment at this section consists of compacted bottom ash with a 15-foot wide compacted clay liner on the upstream slope. The embankment bears directly onto the top of the local bedrock consisting of weathered shale.

Approximately 50 ft of hydraulically-placed fly ash is impounded behind the embankment at the cross section location. The existing fly ash is associated with deposition in Ash Pond 3 which predates the LDWP. The LDWP lies on top of the existing fly ash, hydraulically separated by a dual HDPE liner.

West Embankment (Steepest Overall Slope): This cross-section is located just south of the Section D as shown on Figure 5-1 and the as-built section (Appendix A). This section represents the steepest overall slope inclination from crest to toe. The embankment is approximately 92 ft high from crest to toe at this location. The upstream slope is inclined at 2.5H:1V. The downstream slope is inclined overall from crest to toe at 1.9H:1V. This section also contains a mid-height bench at an approximate elevation of EL 5,176 ft, 42 ft below the crest. The embankment at this section consists of compacted bottom ash with a 15-foot wide compacted clay liner on the upstream slope. The embankment bears directly onto the top of the local bedrock consisting of weathered shale.

Approximately 50 ft of hydraulically-placed fly ash is impounded behind the embankment at the cross section location. The existing fly ash is associated with deposition in Ash Pond 3 which predates the LDWP. The LDWP pond lies on top of the existing fly ash, hydraulically separated by a dual HDPE liner.

South Embankment: This cross section corresponds approximately to Section E as shown on Figure 5-1 and the as-built section (Appendix A). The embankment is approximately 58 ft high from crest to toe at this location. The upstream slope is inclined at 2.5H:1V. The downstream slope is inclined overall from crest to toe at 1.5H:1V. This section contains a mid-height bench at an approximate elevation of EL 5,178 ft, 40 ft below the crest. The embankment at this section consists of compacted bottom ash with compacted clay on the upstream slope. The embankment bears directly onto the top of the local bedrock consisting of weathered shale.

Approximately 61 ft of hydraulically-placed fly ash is impounded behind the embankment at the cross section location. The existing fly ash is associated with deposition in Ash Pond 3 which predates the LDWP. The LDWP pond lies on top of the existing fly ash, hydraulically separated by a dual HDPE liner.

5.3 Subsurface Stratigraphy

Idealized models of subsurface stratigraphic conditions for each cross section were developed based on as-built drawings (Appendix A). The stratigraphic units described as follows were used to develop SLOPE/W models for each cross section.

Compacted Bottom Ash: The LDWP Embankment primarily consists of compacted bottom ash. The bottom ash provides stability to the embankment, but because of its relatively high hydraulic conductivity is not relied upon to control seepage from the pond which is managed by a dual HDPE liner and compacted clay liner on the upstream slope. The compacted bottom ash classifies as a Silty Sand (SM) based on the Unified Soil Classification System (USCS).

Compacted Clay: The LDWP Embankment includes a less pervious layer of compacted clay along the upstream slope. The layer is about 15 ft wide and runs from the toe to the crest. The clay material was obtained from local weathered shale, broken down and mechanically compacted in lifts. The compacted clay consists predominately of Lean Clay (CL) based on the USCS.

Existing Fly Ash: Fly ash waste product from the power generating process associated with the decommissioned Ash Pond 3. The fly ash was pumped from the plant to the Ash Pond 3 and allowed to settle hydraulically. The LDWP lies on top of the existing fly ash, hydraulically separated by a dual HDPE liner. The existing fly ash classifies as silt (ML) based on the USCS.

Weathered Shale: Bedrock beneath the embankment consists of weathered shale of the Cretaceous-age Lewis Shale Formation.

5.4 Material Properties

Material properties for soil, rock and embankment construction materials were developed based on an analysis and interpretation of historical geologic and geotechnical data presented in:

- URS Corporation, "Final Geotechnical Analysis Report – Lined Ash Impoundment Embankment" (URS, 2004) and
- URS Corporation, "Slope Stability Evaluation Lined Decant Water Pond Technical Memorandum" (URS, 2012).

The material properties developed by the embankment designers and subsequent investigators were assessed for reliability and applicability to this safety factor assessment. The slope stability evaluation report (URS, 2012) indicated that soil strength parameters were obtained from laboratory testing.

The material properties selected for use in the slope stability analyses of the LDWP Perimeter Embankment are presented in Table 5-1. The material properties were obtained from the URS slope stability evaluation (2012) and include unit weight and effective shear strength parameters. No additional material properties were developed for this assessment.

Table 5-1. Selected Material Parameters – LDWP Safety Factor Assessment

Material	Total Unit Weight, γ_T (pcf)	Effective Cohesion, c' (psf)	Effective Friction Angle, ϕ' (degrees)
Compacted Bottom Ash	65	0	34
Existing Fly Ash	90	0	28
Compacted Clay (Compacted Shale)	125	300	20
Weathered Shale (Bedrock)	120	500	30

5.5 Embankment Pore Pressure Distribution

Water levels within the embankment are anticipated to be low because of the geosynthetic liner that lines the pond basin and the compacted clay layer that extends along the upstream slope of the embankment. The water level data in eight Piezometers installed along the crest of the embankment were examined. The piezometers are monitored on an interval not exceeding 30 days and reported annually in an inspection report. These data were considered to be the most reliable indicators of pore pressure distribution within the LDWP embankment. Seven of the eight piezometers measured “dry” in the most recent inspection report (AECOM & APS, 2016), while the eighth indicated water levels at a depth within the weathered shale foundation. These measurements confirm the anticipated low water levels in the embankment. Consequently, the phreatic levels within the embankment were lowered to the contact zone of the weathered shale foundation in the cross sections and the steady-state seepage condition within the embankment was modeled as a dry condition. The locations of the piezometers along the embankment crest are shown on Figure 1-2.

5.6 Embankment Loading Conditions

Per 40 CFR § 257.73(e)(1)(i) through (iv), the following loading conditions were analyzed for each developed stability cross section:

- Long-term, maximum storage pool
- Maximum surcharge pool
- Seismic loading, and
- Liquefaction

These loading conditions are described in the following sub-sections.

Long-Term, Maximum Storage Pool: The maximum storage pool loading is the maximum water level that will be maintained for a sufficient length of time for steady-state seepage or hydrostatic conditions to develop within the embankment. This loading condition is evaluated to document whether the CCR surface impoundment can withstand a maximum expected pool elevation with full development of the anticipated saturation in the embankment under long-term loading.

The long-term, maximum storage pool loading condition was evaluated using the maximum operating level calculated for the LAI 5280 Lift (URS, 2012). For the LDWP, the safety factor was calculated for the long-term maximum storage pool at EL 5,209.9 ft (URS, 2012).

Maximum Surcharge Pool: The maximum surcharge pool loading is the temporary rise in pool elevation above the maximum storage pool elevation to which the CCR surface impoundment could be subject under inflow design flood state. This loading condition is evaluated to document whether the downstream slope of the CCR surface impoundment embankment can withstand the short-term impact of a raised pool level.

The maximum surcharge pool considers a temporary pool elevation that is higher than the maximum storage pool that persists for a length of time sufficient for the anticipated steady-state seepage or hydrostatic conditions to fully develop within the embankment. The maximum surcharge pool loading condition was evaluated using the expected water level raise during the

design PMF of 4.1 ft (URS, 2012). For the Fly Ash Pond, the safety factor was calculated for the maximum surcharge pool at EL 5,214 ft.

Seismic Loading: Seismic loading is evaluated to document whether the embankment is capable of withstanding a design earthquake without damage to the foundation or embankment that would cause a discharge of contents. The seismic loading condition is assessed for a seismic loading event with a two percent probability of exceedance in 50 years, equivalent to a return period of approximately 2,500 years. A pseudo-static analysis was used to represent the seismic loading condition.

The seismic response of soil embankments is incorporated into the analysis method by adding a horizontal force to simulate the seismic force acting on the embankment during an earthquake. The horizontal force is applied in the pseudo-static analyses through the addition of a seismic coefficient into the limit equilibrium calculations. The seismic coefficient was selected using the following procedure:

1. Determine the peak horizontal ground acceleration (PGA) generated in bedrock at the site by an earthquake having the 2% probability of exceedance in 50 years;
2. Select a Site Class, per International Building Code definitions, which incorporates the effects of seismic wave propagation through the top 100 ft of the soil profile above bedrock, and calculate the adjusted for Site Class effects, PGA_M ;
3. Calculate the maximum transverse acceleration at the crest of the embankment, PGA_{crest} , using the PGA_M from step two; and
4. Adjust the PGA_{crest} using the method developed by Makdisi and Seed (1977) to account for the variation of induced average acceleration with embankment depth to calculate the seismic coefficient.

Each of these steps is discussed in more detail in the calculation presented in Appendix B. The maximum average acceleration for the potential sliding mass was incorporated into the pseudo-static safety factor analyses as the horizontal seismic coefficient equal to 0.083, corresponding to the calculated, adjusted PGA_{crest} value.

The water level in the LDWP for the seismic loading analysis was set to EL 5,209.9 ft to match the long-term, maximum storage pool. All materials were assigned effective strengths because it is anticipated that they would behave in a drained manner due to the relatively high hydraulic conductivity of the materials and low phreatic surfaces within the embankment.

Liquefaction: The liquefaction factor of safety is evaluated for CCR embankments and foundation soils that are believed to be susceptible to liquefaction based on representative soil sampling and construction documentation or anecdotal evidence from personnel with knowledge of the CCR unit's construction. The liquefaction factor of safety is calculated to document whether the CCR unit would remain stable if the soils in the embankment and/or foundation experienced liquefaction.

A liquefaction factor of safety analysis was not performed for this impoundment because the LDWP embankment materials, consisting of compacted bottom ash and compacted clay, and the foundation materials, consisting of weathered shale beneath the west and south side of the impoundment and existing fly ash beneath the north and east side, are not considered to be liquefiable based on their relative density, high fines content, and plasticity.

5.7 Safety Factor Assessment Results

Table 5-2 summarizes the results of the safety factor analysis for the LDWP Perimeter Embankment, for a more detailed discussion of the results see the safety factor calculation presented in Appendix B.

Table 5-2. Summary of Calculated Safety Factors

Loading Condition	Required Safety Factor ^[1]	Calculated Safety Factor		
		West Embankment (Steepest Upper Section)	West Embankment (Steepest Overall Section)	South Embankment
Long-term, maximum storage pool	1.50	1.51	1.58	1.58
Maximum surcharge pool	1.40	1.51	1.58	1.58
Seismic	1.00	1.24	1.29	1.31

Notes: [1] From 40 CFR § 257.73(e)(1)(i) through (iii) (EPA, 2015)

The calculated factors of safety for the three critical cross sections along the LDWP Perimeter Embankment exceeded the required minimum values for the long-term, maximum storage pool; the maximum surcharge pool; and the seismic (pseudo-static) loading conditions.

6 Conclusions

Based on the findings and results of the structural integrity assessment, AECOM provides the following conclusions for the LDWP at the FCPP.

- The LDWP is classified as a Significant Hazard Potential CCR surface impoundment.
- The LDWP embankments, including the LDWP perimeter embankment and incorporated embankments of the west and south sides of Ash Pond 3, are founded on stable foundations. There are no abutments. Seepage is managed by a dual HDPE liner with a leak detection system that extends to the crest of the perimeter embankment.
- The embankment has double-layer HDPE liner with clay on the upstream slope to prevent erosion. The downstream slopes are constructed with bottom ash and are not vegetated. The granular nature of bottom ash generally allows infiltration in preference to runoff and erosion. APS has a regular program of inspection and repair of erosion rills.
- Based on the available information and quality control test results, the LDWP embankment was mechanically compacted to a density sufficient to withstand the range of loading conditions anticipated at the site.
- The LDWP impoundment is capable of adequately managing the flow during and following the peak discharge from the PMF event without a spillway or other water release structures because the pond has been designed, constructed, operated, and maintained with sufficient storage volume above the maximum storage pool water level to store the PMF inflow from both the LDWP and LAI and maintain at least two ft of freeboard.
- Factors of safety greater than the minimum values required by the CCR Rule were calculated for three cross sections along the LDWP embankment for loading conditions associated with the maximum storage pool water level, maximum surcharge pool water level, and design level seismic event. The liquefaction loading stability factor of safety of the impoundment was not analyzed due to the low potential for soil liquefaction of the embankment and foundation soils.
- Based on review of available records concerning the LDWP and the results of the stability analyses, no deficiencies were noted that would affect the structural condition of the dam.

7 Limitations

This report is for the sole use of APS on this project only, and is not to be used for other projects. In the event that conclusions based upon the data obtained in this report are made by others, such conclusions are the responsibility of others. The Initial Structural Stability Assessment presented in this report was based on available information identified in Reference Section of the report that AECOM has relied on but not independently verified. Therefore, the Certification of Professional Opinion is limited to the information available to AECOM at the time the Assessment was performed in accordance with current practice and the standard of care. Standard of care is defined as the ordinary diligence exercised by fellow practitioners in this area performing the same services under similar circumstances during the same period. Professional judgments presented herein are primarily based on information from previous reports that were assumed to be accurate, knowledge of the site, and partly on our general experience with dam safety evaluations performed on other dams. No warranty or guarantee, either written or implied, is applicable to this work.

The use of the words “certification” and/or “certify” in this document shall be interpreted and construed as a Statement of Professional Opinion and is not and shall not be interpreted or construed as a guarantee, warranty, or legal opinion.

8 References

- AECOM and Arizona Public Services Company (APS), 2016, "Four Corners Power Plant Lined Ash Impoundment, Lined Decant Water Pond, Combined Waste Treatment Pond, Upper Retention Sump, and Dry Fly Ash Disposal Area: Annual CCR Impoundment and Landfill Report 2015", January.
- APS, 2003, As-built Drawings No. 150793, Sheets 1 through 7, January.
- GEOSLOPE International, 2012, GeoStudio 2012, Version 8.15.4.11512, August 2015 Release.
- Makdisi, F.I. and Seed, H.B., 1977, "A Simplified Procedure for Estimating Earthquake-Induced Deformations in Dams and Embankments," Report No. UCB/EERC-77/19, University of California, Berkeley, August.
- New Mexico Office of The State Engineer (NMOSE), 2008, Certificate of Construction, Certificate No. D-635, February, 7.
- NMOSE, 2008, License to Operate, Line Decant Water Pond, License No. D-635, February, 7.
- United States Environmental Protection Agency (EPA), 2015, 40 CFR Parts 257 and 261 – Hazardous and Solid Waste Management System; Disposal of Coal Combustion Residuals from Electric Utilities; Final Rule, Federal Register Vol. 80, No. 74, April 17.
- United States Geological Survey (USGS), 2013, 7.5-Minute Series The Hogback North, NM Quadrangle Map.
- URS Corporation (URS), 2009, "Four Corners Power Plant Ash Disposal Impoundments Breach and Inundation Study, San Juan County, New Mexico, NMOSE File No. D-634 and B-635" Prepared for Arizona Public Service Company, URS Job No. 23445321, April 1.
- URS, 2012, "Engineering Design Report: Lined Ash Impoundment 5280 Lift, Four Corners Power Plant, San Juan County, New Mexico," Prepared for Arizona Public Service, URS Job No. 23446085, March.
- URS Corporation, 2014, "Operations and Maintenance Manual Lined Ash Impoundment and Lined Decant Water Pond – Four Corners Power Plant," Prepared for Arizona Public Service, URS Job No. 23445321, May.

Figures

Last saved by: KINGJ3(2016-07-01) Last Plotted: 2016-07-11
Filename: P:\ARIZONA PUBLIC SERVICE\60445844_APS_FCPP_STRUCTURAL_INTEGRITY\STRUCTURAL INTEGRITY REPORTS\CADD\FIGURE 1-1_SITE VICINITY MAP.DWG



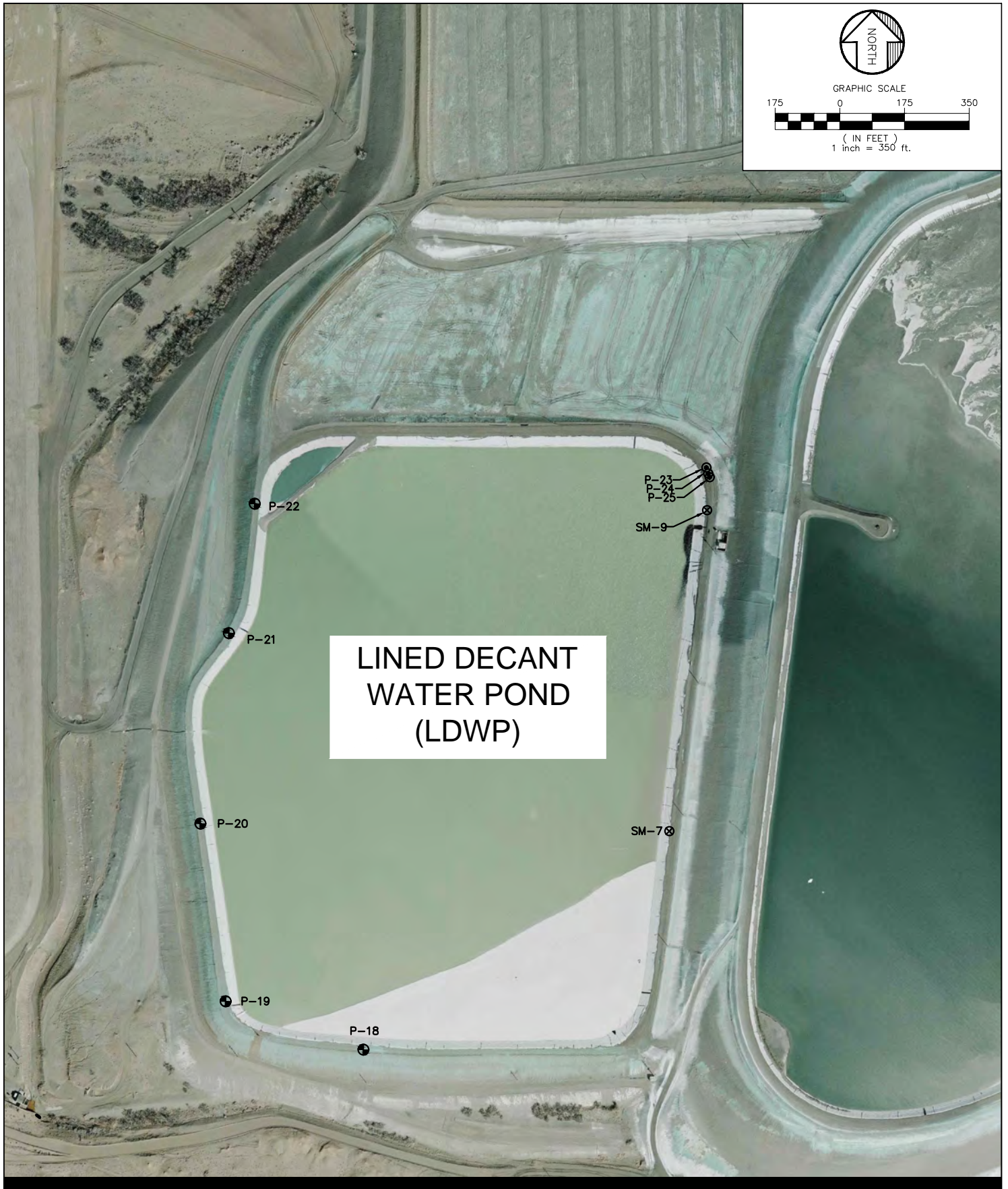

Last saved by: KINGJ3(2016-06-30) Last Plotted: 2016-07-01
Filename: P:\ARIZONA PUBLIC SERVICE\60445844_APS_FCPP_STRUCTURAL_INTEGRITY\STRUCTURAL INTEGRITY REPORTS\CADD\FIGURE 4-1_TOPOGRAPHY.DWG

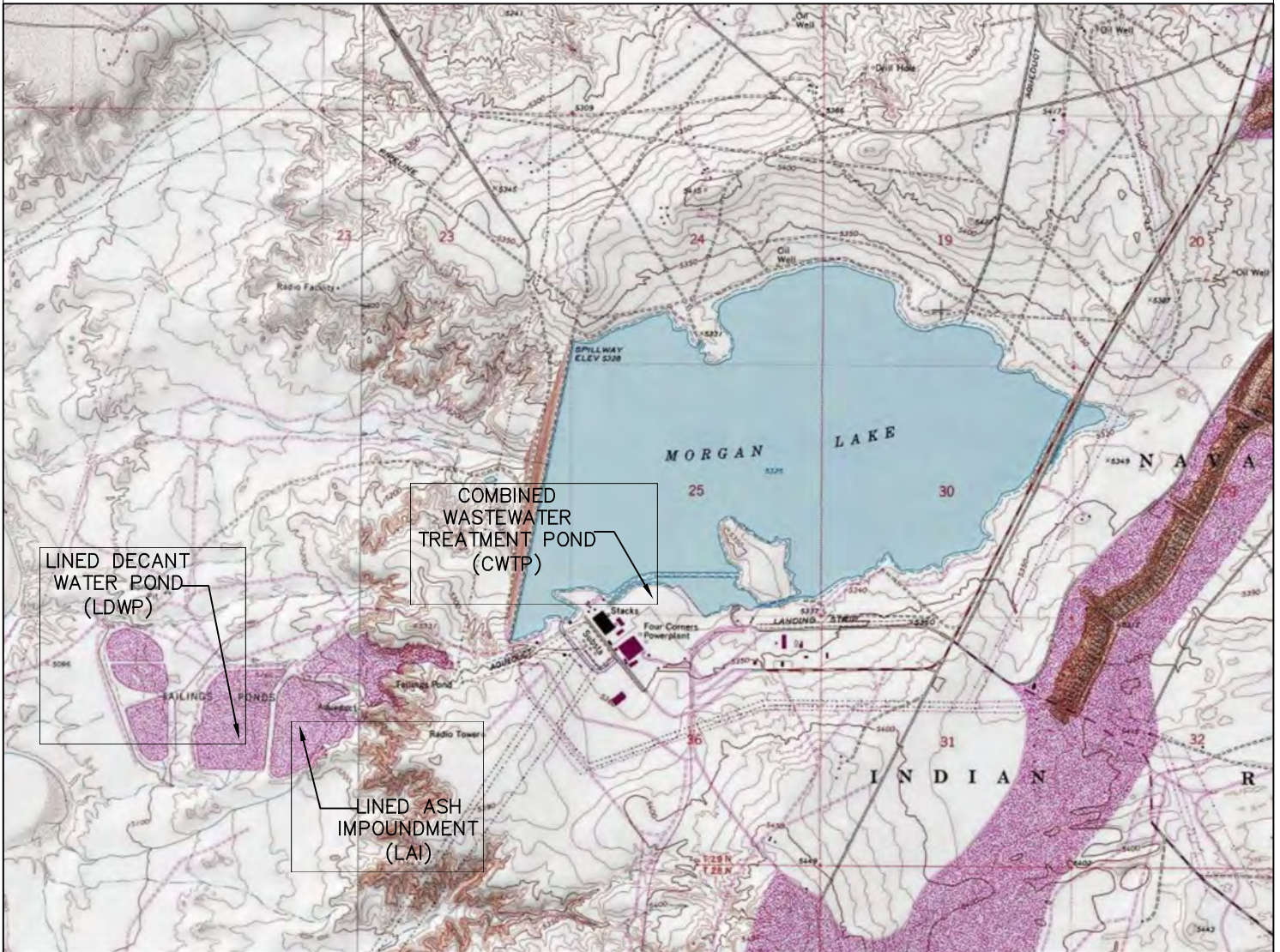
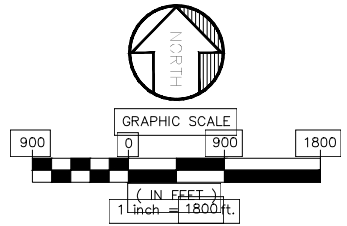

Last saved by: KINGJ3(2016-07-07) Last Plotted: 2016-07-07
 Filename: P:\ARIZONA PUBLIC SERVICE\60445844_APS_FCPP_STRUCTURAL_INTEGRITY\STRUCTURAL INTEGRITY REPORTS\CADD\FIGURE 4-2_AREACAPACITYCURVE_LDWP.DWG

LDWP* (Basin H)

Reservoir Elevation (ft)	Total Surface Area (acre)	Cumulative Storage (acre-ft)
5206	40	120
5213.2	45	435
5216	46	517

* From Dam Owner's Certificate

Basin H (LDWP) Elevation-Area-Capacity+

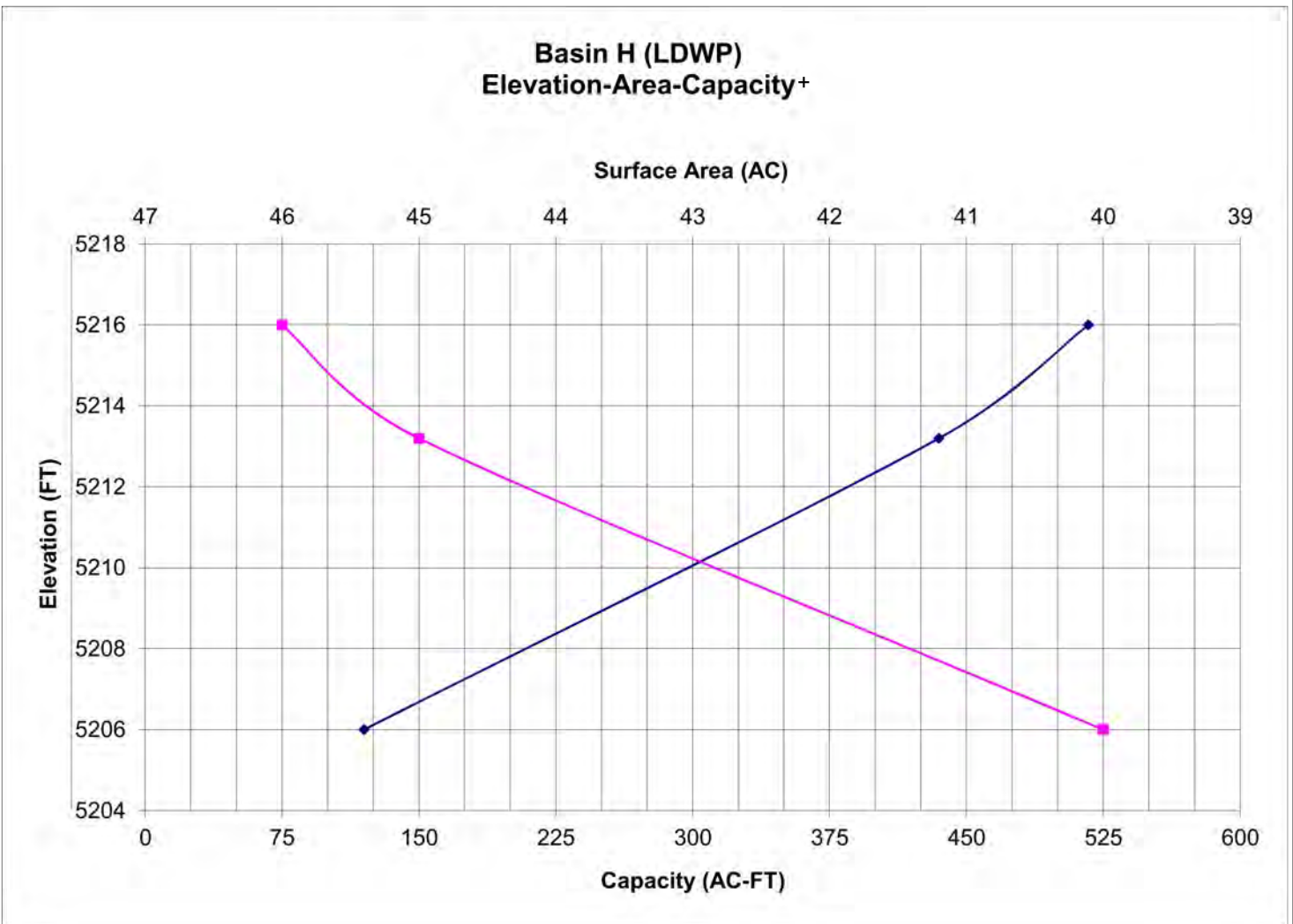

+ From LAI Engineering Design Report (URS 2012)

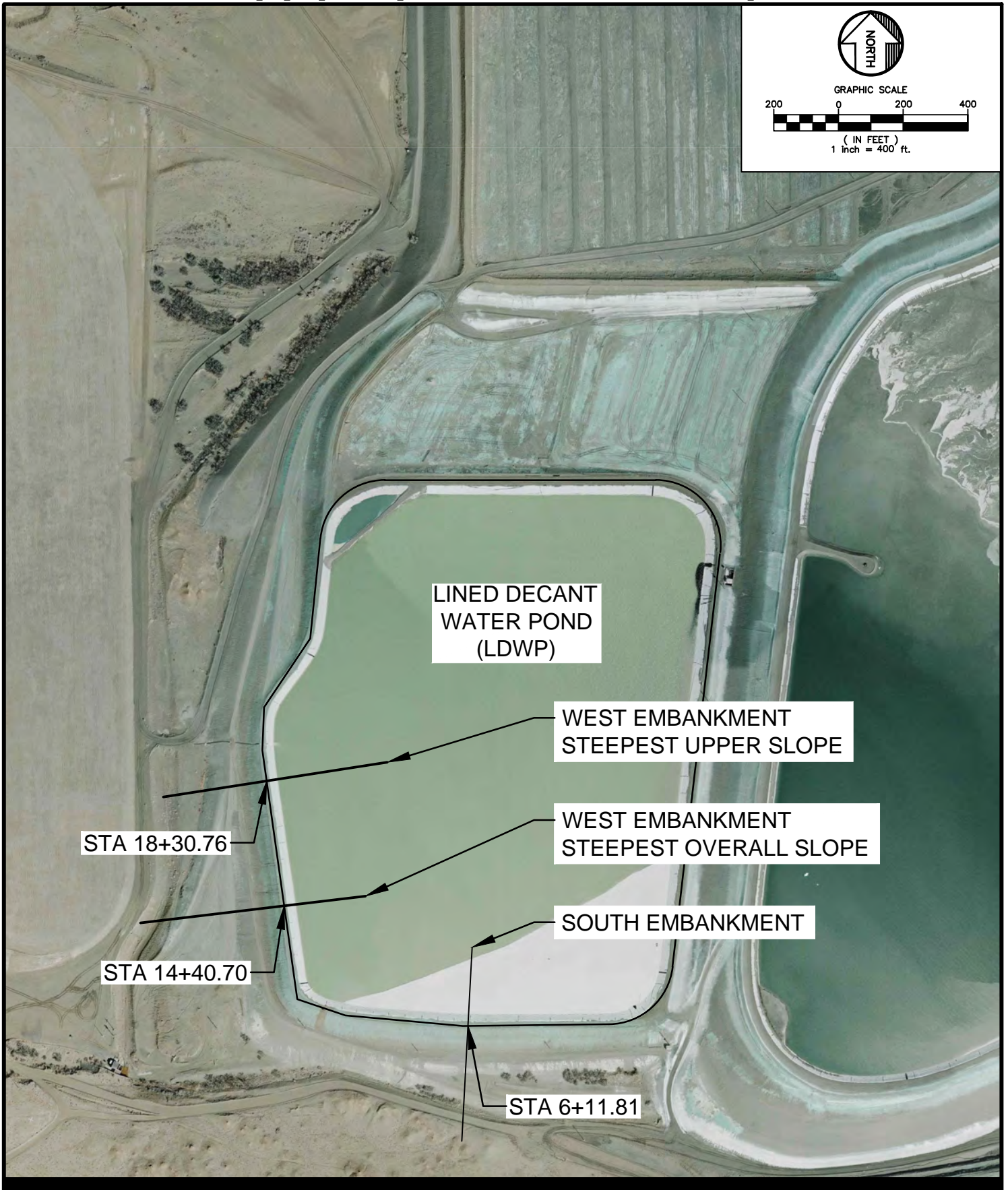

Appendix A. Historic Drawings

ASH POND 3 DRAWINGS
(APS, 1984)

ASH STORAGE SYSTEM

SHORT LIFT OPTION

FOUR CORNERS POWER PLANT

SAN JUAN COUNTY, NEW MEXICO

MAPS OF THE
ASH STORAGE SYSTEM
FOR THE
FOUR CORNERS POWER PLANT, UNITS 1-3
ARIZONA PUBLIC SERVICE COMPANY, CLAIMANT
LOCATED IN SAN JUAN COUNTY, STATE OF NEW MEXICO

The undersigned, Arizona Public Service Company, Claimant, whose post office address is Post Office Box 31666, City of Phoenix, County of Maricopa, State of Arizona, constructed a number three Ash Disposal Dam in 1964 at the Four Corners Power Plant. Claimant proposes to increase the height of ash disposal dams for Ash Ponds 3 and 4 and related appurtenances as hereinafter described and indicated, hereby makes these several statements relative thereto, and offers those maps and statements for acceptance and filing in compliance with the laws of the State of New Mexico.

The proposed ash disposal dam has the following properties: maximum height above foundation 86 feet; crest length 6600 feet; maximum width at base 210 feet; crest width 20 feet; slope of upstream face 1.5 horizontal to 1 vertical; slope of downstream face 1.5 horizontal to 1 vertical with a 40 foot wide horizontal bench located at elevation 5164 feet; elevation of crest is 5210 feet. Discharge capacity of the 10" decant system is 2.5 cubic feet per second.

All surface runoff waters from the precipitation occurring above the dam will be contained in the pond.

The dam will be rolled earth fill of gravity type placed on top of the existing dams, and on natural ground. Control of seepage will be maintained by constructing seepage pathways of selected materials. Seepage will be collected for controlled disposal.

Water retention within the pond area is to be held to a minimum, with only sufficient pond area maintained to accomplish settlement of ash before decanting from pond area.

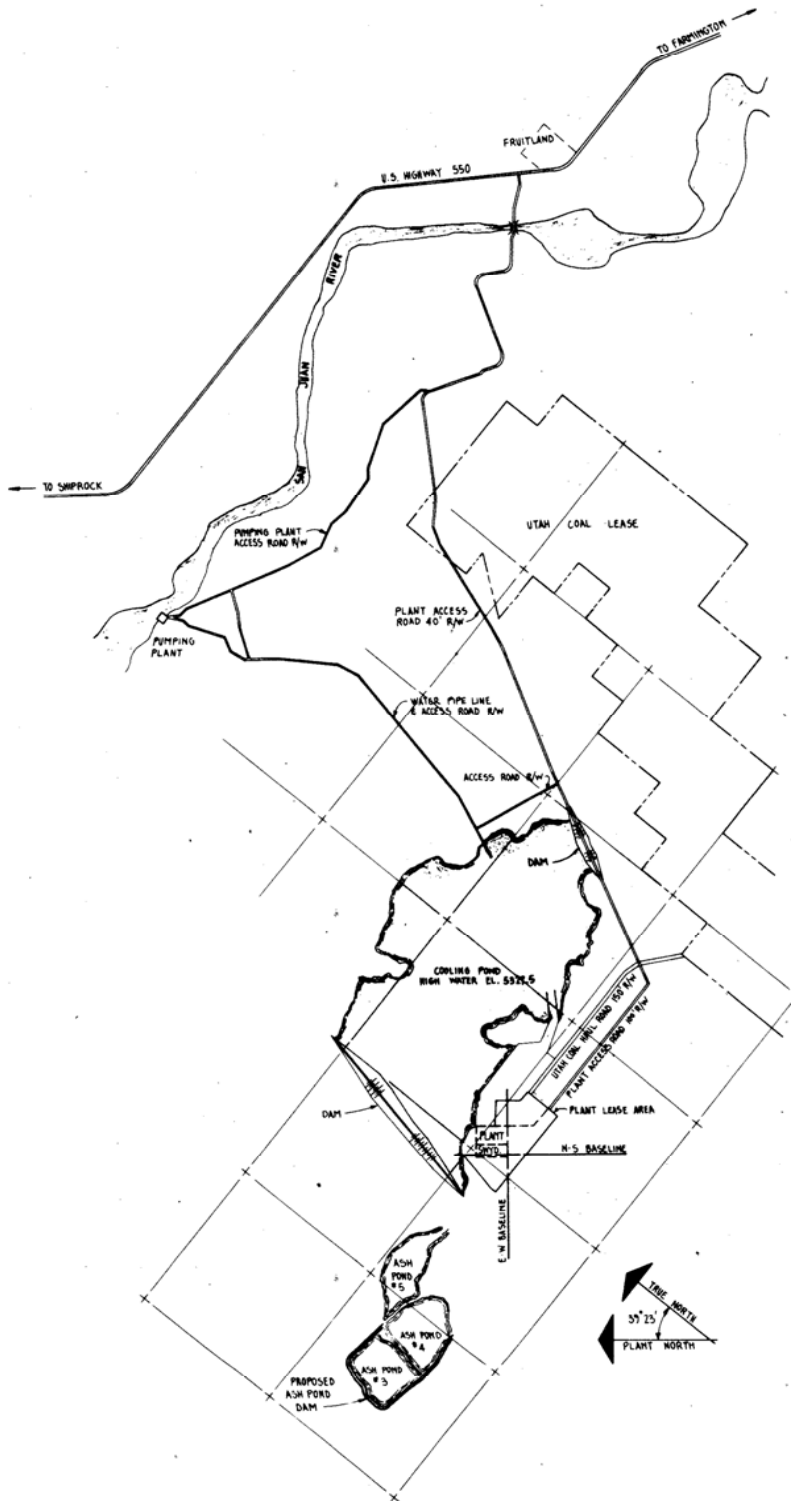

VICINITY MAP
1" = 3000'

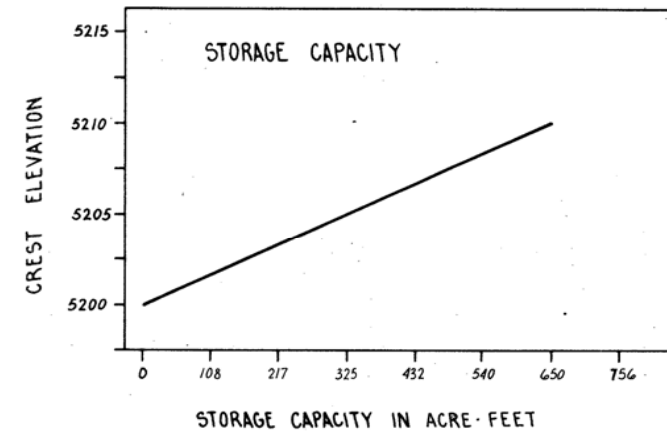

STATE OF ARIZONA
COUNTY OF MARICOPA

I, WALTER EKSTROM BEING FIRST DULY SWORN, UPON MY OATH STATE THAT I AM THE VICE-PRESIDENT OF ARIZONA PUBLIC SERVICE COMPANY, A CORPORATION DULY ORGANIZED UNDER THE LAWS OF THE STATE OF ARIZONA, THAT THE ACCOMPANYING MAPS AND STATEMENTS WERE MADE UNDER AUTHORITY OF THE BOARD OF DIRECTORS OF SAID CORPORATION, AND THAT, IN THEIR BEHALF, I HAVE READ AND EXAMINED THE STATEMENTS AND REPRESENTATIONS THEREON AND STATE THAT THE SAME ARE TRUE TO THE BEST OF MY KNOWLEDGE AND BELIEF.

ARIZONA PUBLIC SERVICE COMPANY,
CLAIMANT

Walter F. Ekstrom
BY: WALTER EKSTROM, VICE-PRESIDENT

SUBSCRIBED AND SWORN TO BEFORE ME THIS 14th DAY OF August, 1984.

Janet M. Landgren
NOTARY PUBLIC
MY COMMISSION EXPIRES May 30, 1985

STATE OF ARIZONA
COUNTY OF MARICOPA

I, GEORGE H. GLOS BEING FIRST DULY SWORN, UPON MY OATH, STATE THAT I AM THE REGISTERED PROFESSIONAL ENGINEER RESPONSIBLE FOR THE MAPS OF ASH DISPOSAL DAM NUMBER THREE AND RELATED APPURTANANCES OF THE FOUR CORNERS POWER PLANT AND THAT SUCH MAPS ARE TRUE AND CORRECT TO THE BEST OF MY KNOWLEDGE AND BELIEF.



George H. Glos
BY: GEORGE H. GLOS, REGISTERED PROFESSIONAL ENGINEER

LICENSE NUMBER *6884

SUBSCRIBED AND SWORN TO BEFORE ME THIS 14th DAY OF August, 1984.

Janet M. Landgren
NOTARY PUBLIC
MY COMMISSION EXPIRES May 30, 1985

STATE OF NEW MEXICO
COUNTY OF SANTA FE

I HEREBY CERTIFY THAT THE ACCOMPANYING MAPS AND STATEMENTS HAVE BEEN EXAMINED BY ME AND APPROVED AS TO FORM AND CONTENT, AND WERE DULY ACCEPTED FOR FILING ON THE 18th DAY OF SEPT, 1984.

E.H. Fox
NEW MEXICO STATE ENGINEER

INDEX

- E-82728 TEST BORING LOCATION PLAN
- E-82729 (2 SHTS.) BORING LOGS
- E-82730 FINAL ELEVATIONS
- E-82731 CROSS-SECTIONS

NO.	DATE	REVISION #	CHKD	EXTD	APPRO	APPRO	SCALE
FOUR CORNERS POWER PLANT							
TITLE SHEET - SHORT LIFT OPTION							
PROPOSED ASH POND DAM							
ARIZONA PUBLIC SERVICE COMPANY PHOENIX							
DATE <u>3-9-84</u>							
SCALE	DATE	BY	CHKD	EXTD	APPRO	APPRO	SCALE
1" = 3000'		<i>W.F.E.</i>	<i>W.F.E.</i>	<i>W.F.E.</i>	<i>W.F.E.</i>	<i>W.F.E.</i>	1" = 3000'
							PROJECT NO. E-82727
							SHEET 1 OF 1

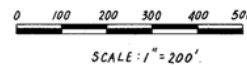
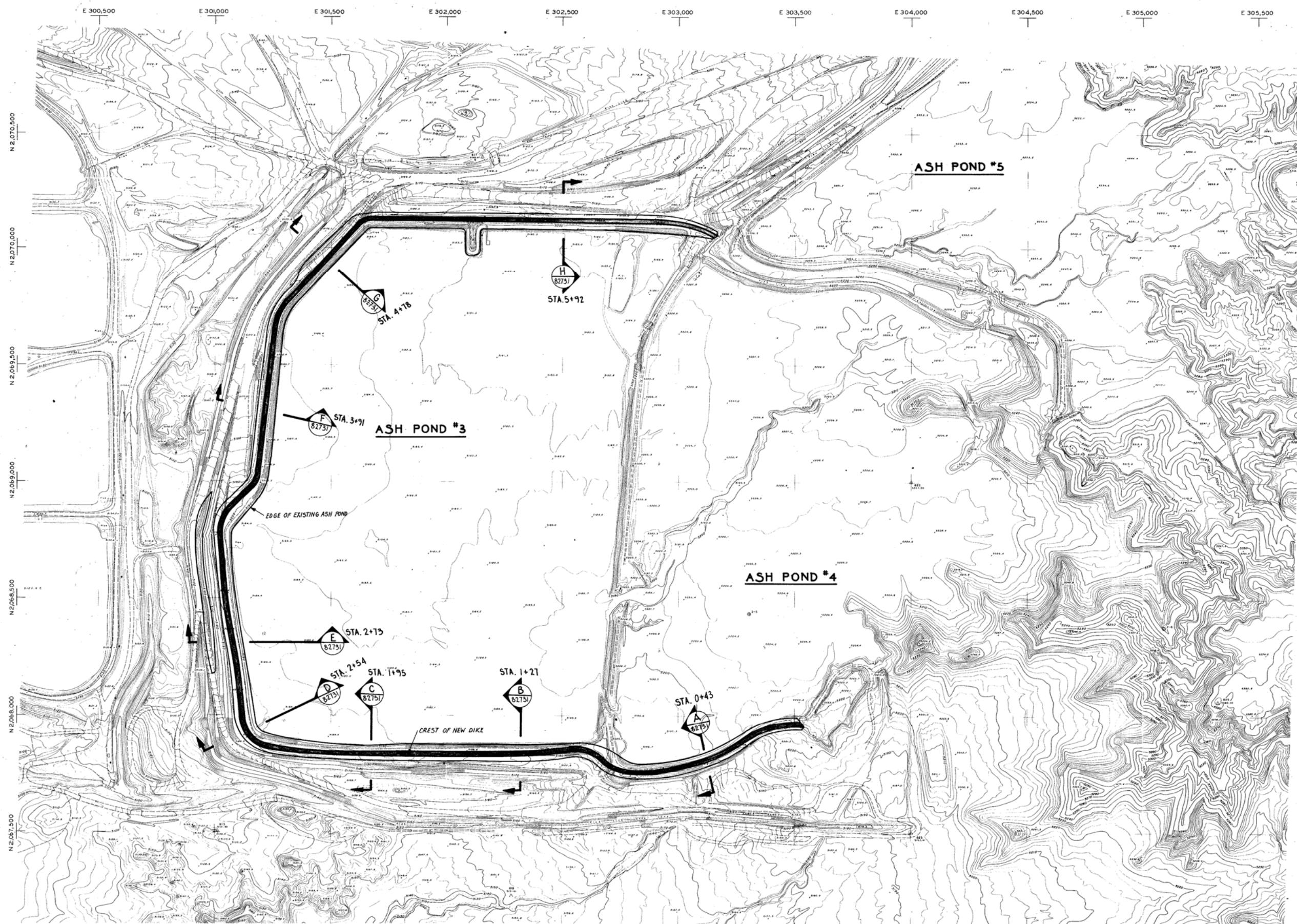

REFERENCE	DWG NO.	DESCRIPTION
	E-82731	PROPOSED ASH POND - CROSS SECT.
	E-82728	TEST BORING LOCATION - PLAN
	E-82729	TEST BORING LOGS (2 SHTS)

NO.	DATE	REVISION #	OWN	CHK	EXD	APPD	APPD	W.A.
11	04/08/84		KK					
FOUR CORNERS POWER PLANT FINAL ELEVATION SHORT LIFT OPTION PROPOSED ASH POND DAM								
ARIZONA PUBLIC SERVICE COMPANY PHOENIX								
							DATE	3-15-84
							DWG NO.	E-82730
							DRWG. NO.	90-5301
							SHEET	1 OF 1

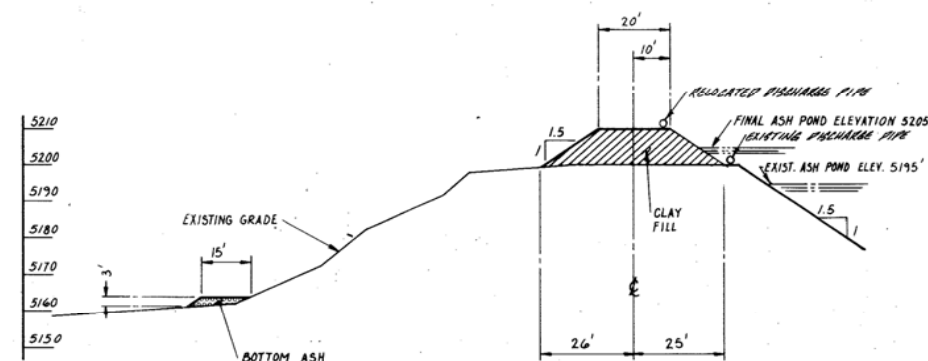
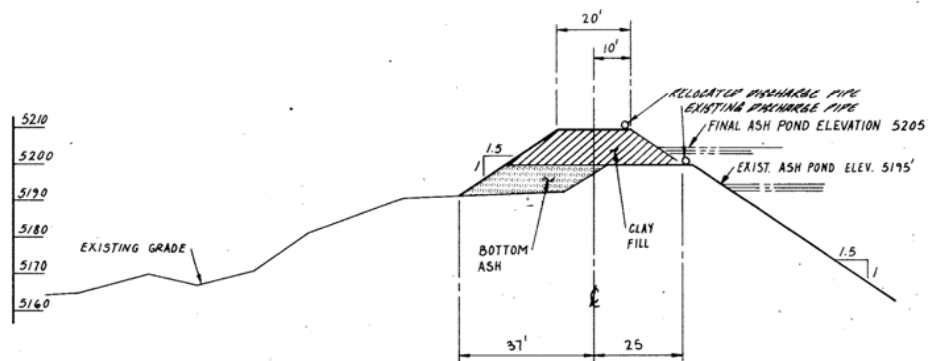
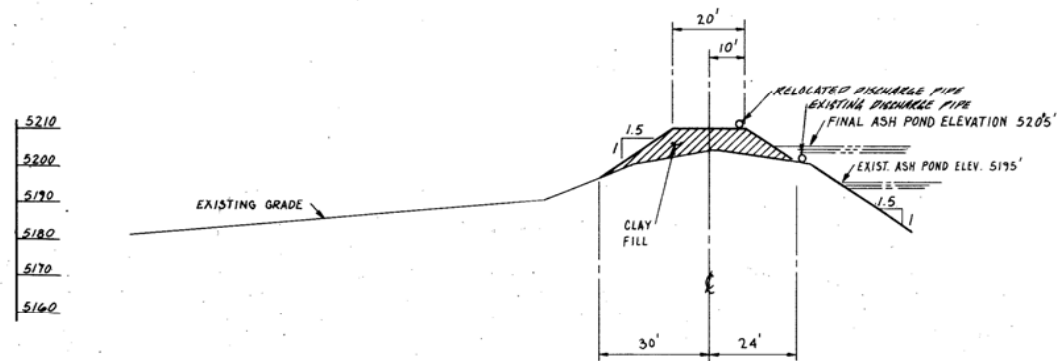

SECTION A A SCALE: 1" = 25'

SECTION B B SCALE: 1" = 25'

SECTION C C SCALE: 1" = 25'

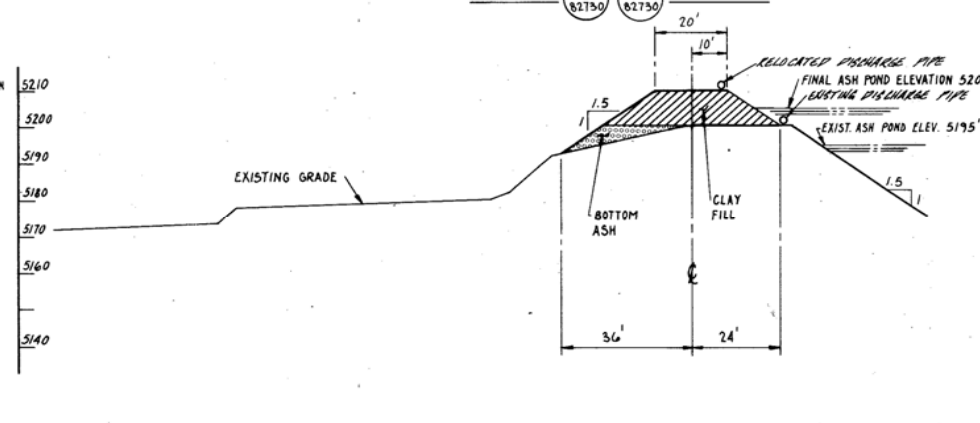
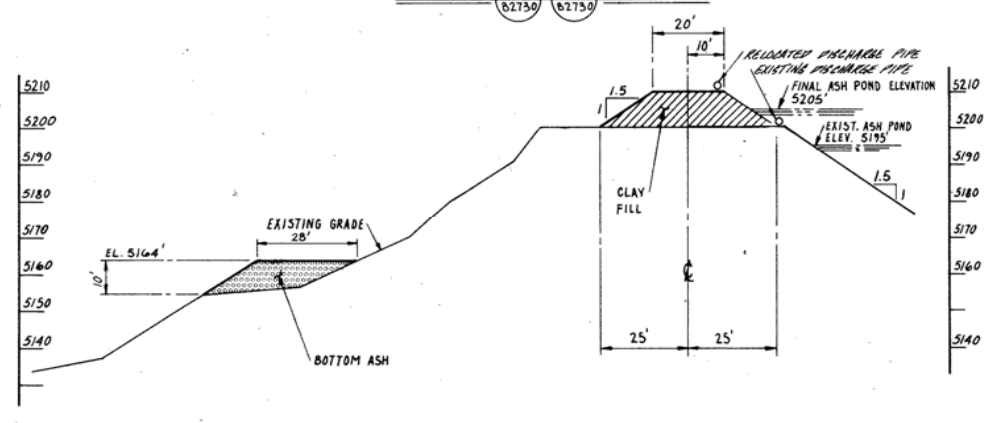
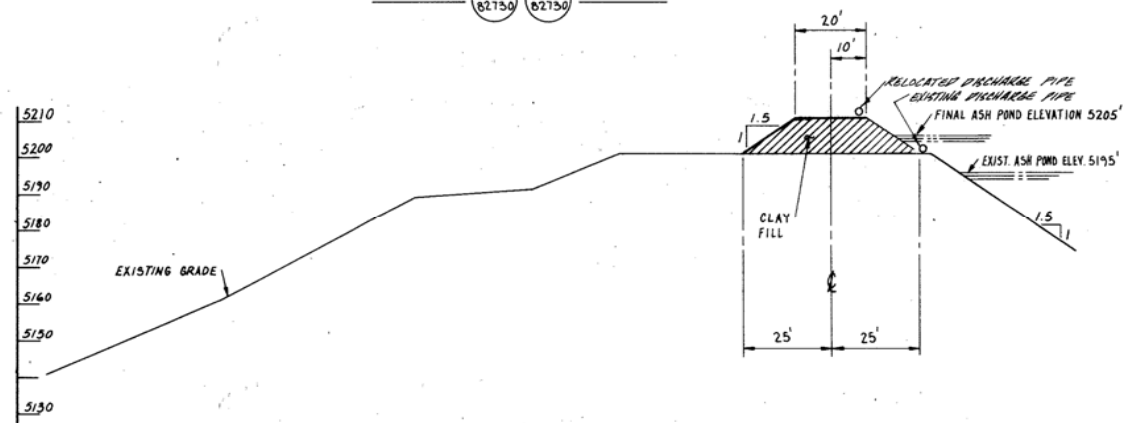

SECTION D D SCALE: 1" = 25'

SECTION E E SCALE: 1" = 25'

SECTION F F SCALE: 1" = 25'

MATERIALS PROPERTIES			
DESCRIPTION	WET DENSITY (PCF)	φ DEGREES	c' K.S.F
CLAY FILL	129	29.0	0.90
BOTTOM ASH	80	35.0	0.46
OVERBURDEN	129	11.5	1.12
SHALE	153	30.0	0.96
FLY ASH	90	0.0	0.5

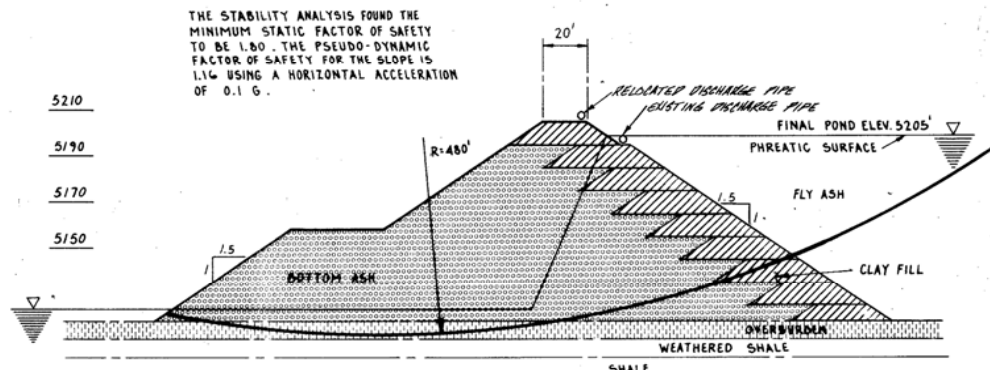
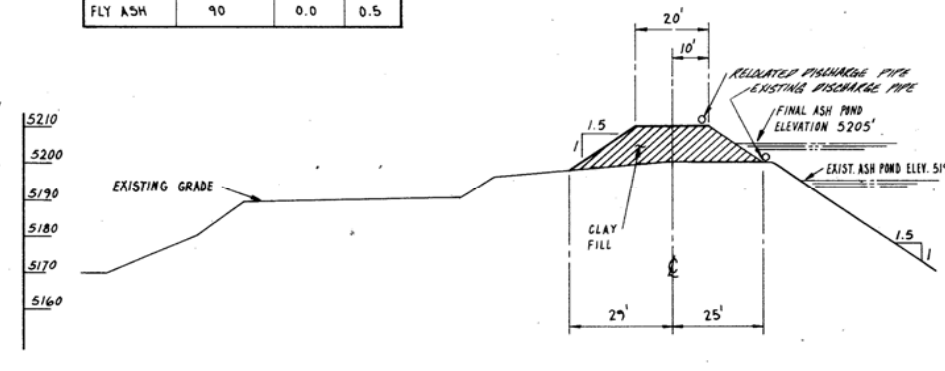
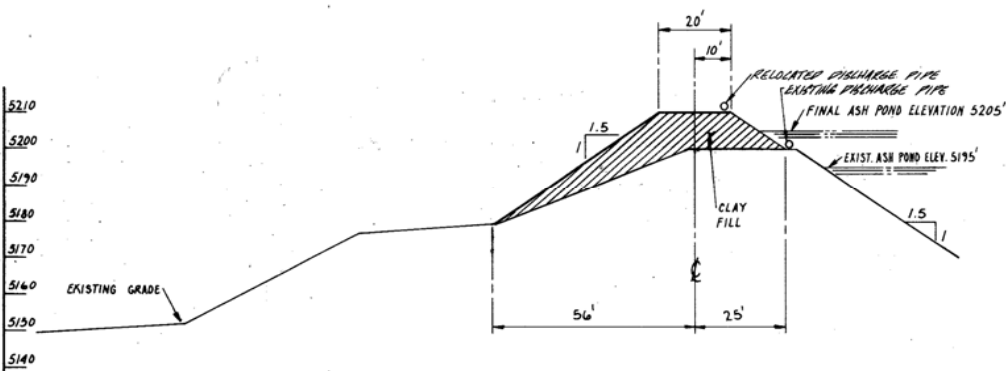

THE STABILITY ANALYSIS FOUND THE MINIMUM STATIC FACTOR OF SAFETY TO BE 1.00. THE PSEUDO-DYNAMIC FACTOR OF SAFETY FOR THE SLOPE IS 1.14 USING A HORIZONTAL ACCELERATION OF 0.1 G.

SECTION G G SCALE: 1" = 25'

SECTION H H SCALE: 1" = 25'

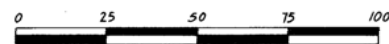

SCALE: 1" = 25'

SLOPE STABILITY SUMMARY

THIS REVISED SHEET ACCEPTED FOR FILING ON THE 27th DAY OF NOVEMBER, 1984
 CHIEF, TECHNICAL DIVISION.

NO.	DATE	REVISION	CHKD	EXTD	APPROV	BY
2	3-16-85	REV. SECT. 'G' PER 'S-BUILD'	KK			AKB
1	11-25-84	ADD EXIST. & RELOCATED DISCHARGE PIPES	PHD			AKB

FOUR CORNERS POWER PLANT
CROSS-SECTIONS SHORT LIFT OPTION
PROPOSED ASH POND DAM
ARIZONA PUBLIC SERVICE COMPANY
PHOENIX
 SCALE AS NOTED DATE 3-15-84
 DRAWING NO. E-82731
 SHEET 1 OF 1

AS-BUILT DRAWINGS
(APS, 2003)

STATE OF ARIZONA
COUNTY OF MARICOPA

I, JOHN R. DENMAN, BEING FIRST DULY SWORN, UPON MY OATH, STATE THAT I AM THE VICE-PRESIDENT OF FOSSIL GENERATION AT ARIZONA PUBLIC SERVICE COMPANY, A CORPORATION DULY ORGANIZED UNDER THE LAWS OF THE STATE OF ARIZONA, THAT THE ACCOMPANYING MAP AND STATEMENTS (MAPS AND STATEMENTS CONSISTING OF 7 SHEETS) WERE MADE UNDER AUTHORITY OF THE BOARD OF DIRECTORS OF SAID CORPORATION, AND THAT, IN THEIR BEHALF, I HAVE READ AND EXAMINED THE STATEMENTS AND REPRESENTATIONS THEREON AND STATE THAT THE SAME ARE TRUE TO THE BEST OF MY KNOWLEDGE AND BELIEF.

ARIZONA PUBLIC SERVICE COMPANY
CLAIMANT

BY: JOHN R. DENMAN, VICE-PRESIDENT
FOSSIL GENERATION

SUBSCRIBED AND SWORN TO BEFORE ME THIS ____ DAY OF _____ 2004

NOTARY PUBLIC
MY COMMISSION EXPIRES _____ (SEAL)

STATE OF NEW MEXICO
COUNTY OF SAN JUAN

I, BYRON CONRAD, BEING FIRST DULY SWORN, UPON MY OATH, STATE THAT I AM A REGISTERED PROFESSIONAL ENGINEER QUALIFIED IN GEOLOGICAL ENGINEERING, AND THAT THE ACCOMPANYING DRAWINGS OF THE LINED DECANT WATER POND AND RELATED APPURTENANCES AT THE FOUR CORNERS POWER PLANT, CONSISTING OF 7 SHEETS, WERE PREPARED BY ME AND ARE TRUE AND CORRECT TO THE BEST OF MY KNOWLEDGE AND BELIEF.

BY:
REGISTERED PROFESSIONAL ENGINEER
LICENSE NUMBER: 13248



SUBSCRIBED AND SWORN TO BEFORE ME THIS ____ DAY OF _____ 2004.

NOTARY PUBLIC
MY COMMISSION EXPIRES _____ (SEAL)

STATE OF NEW MEXICO
COUNTY OF _____

I HEREBY CERTIFY THAT THE ACCOMPANYING DRAWINGS OF THE LINED DECANT WATER POND AND RELATED APPURTENANCES AT THE FOUR CORNERS POWER PLANT HAVE BEEN DULY EXAMINED BY ME AND APPROVED AS TO FORM AND CONTENT, AND WERE DULY ACCEPTED FOR FILING ON THE ____ DAY OF _____ 2004.

NEW MEXICO STATE ENGINEER

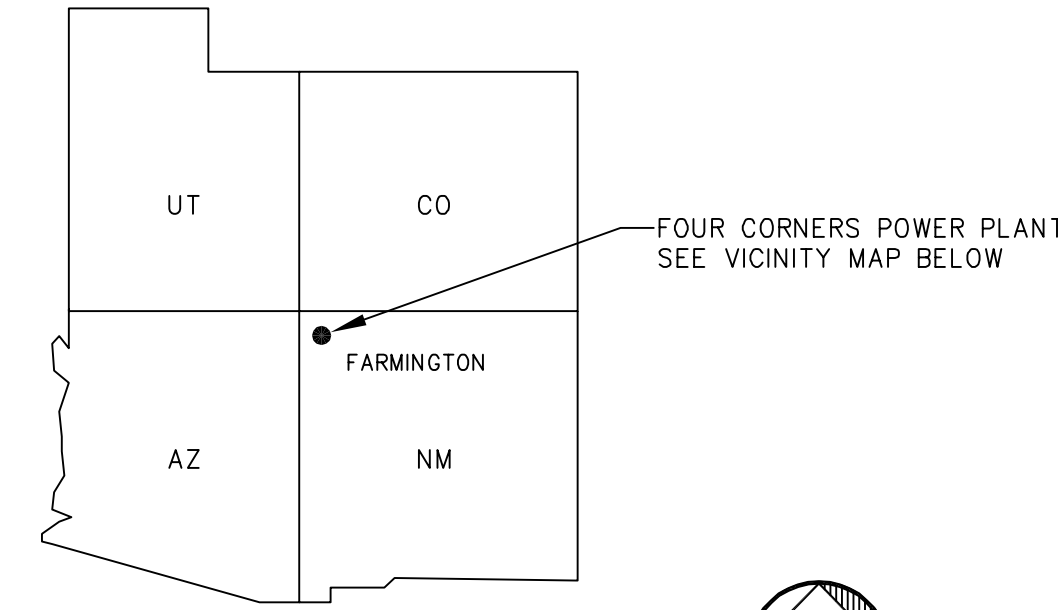
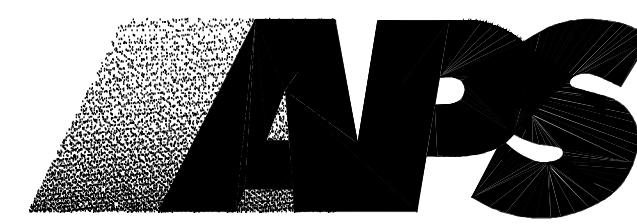

AREA LOCATION MAP

N.T.S.

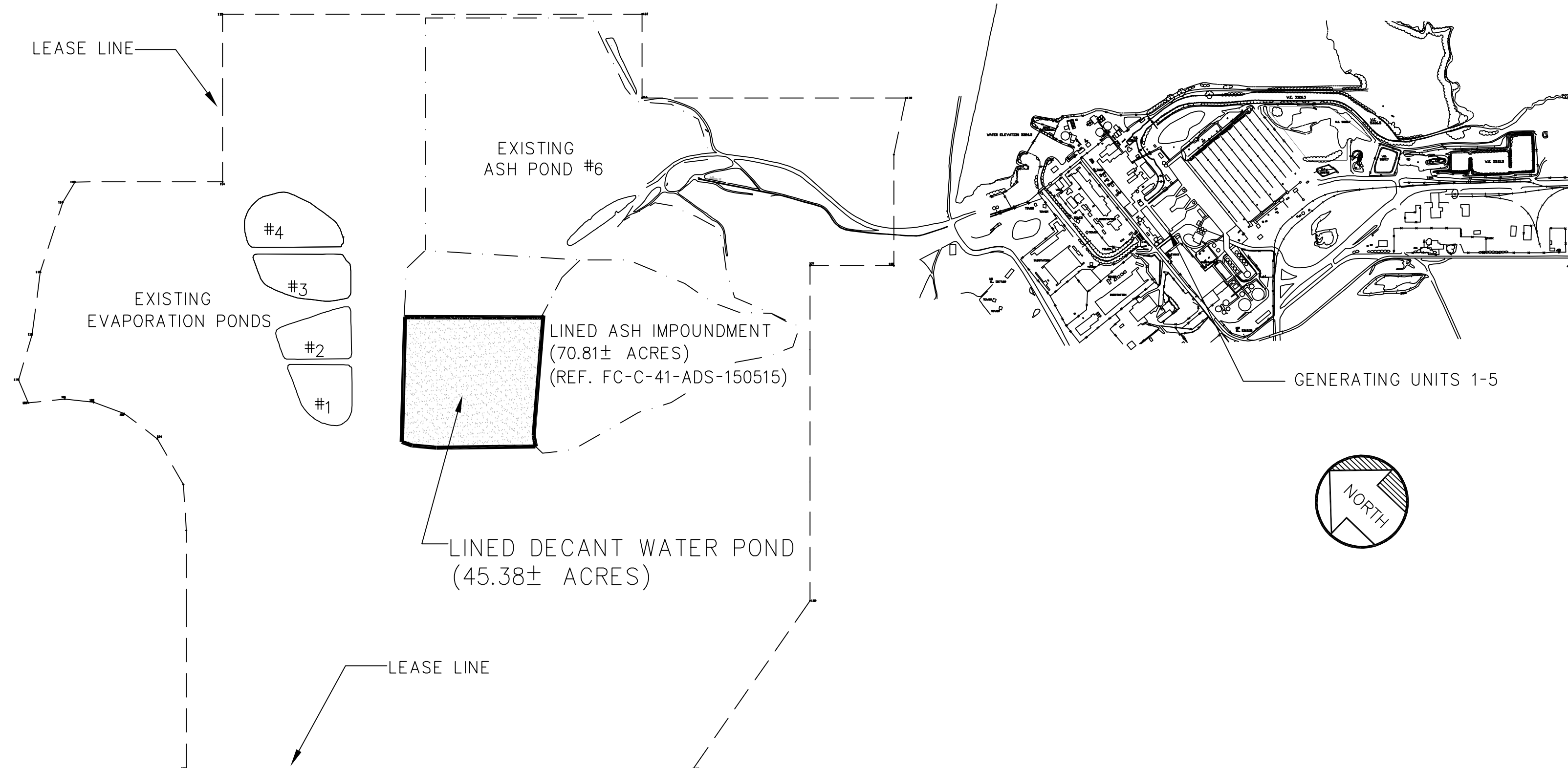
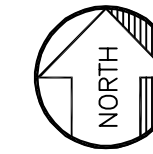

VICINITY MAP

N.T.S.

LIST OF DRAWINGS

DRAWING NUMBER	TITLE
FC-C-41-ADS-150793 SH. 1	FILING SHEET
FC-C-17-ADS-150793 SH. 2	SITE PLAN
FC-C-39-ADS-150793 SH. 3	SECTIONS
FC-C-39-ADS-150793 SH. 4	SECTIONS
FC-C-39-ADS-150793 SH. 5	LONGITUDINAL PROFILE AT CENTERLINE
FC-C-16-ADS-150793 SH. 6	DRAINAGE MAP
FC-C-17-ADS-150793 SH. 7	PIEZOMETER LOCATIONS

ASH STORAGE SYSTEM
LINED DECANT POND PROJECT
FOR THE
FOUR CORNERS POWER PLANT, UNITS 1-3
ARIZONA PUBLIC SERVICE COMPANY
LOCATED IN SAN JUAN COUNTY, STATE OF NEW MEXICO

THE UNDERSIGNED APS COMPANY, CLAIMANT, WHOSE ADDRESS IS POST OFFICE BOX 53933, MAIL STATION 3190, CITY OF PHOENIX, COUNTY OF MARICOPA, STATE OF ARIZONA, CONSTRUCTED ASH DISPOSAL DAMS 3 & 4 AT THE FOUR CORNERS POWER PLANT. WE PROPOSE TO CONSTRUCT A LINED DECANT WATER POND ADJACENT TO AND 350± WEST OF THE EMBANKMENT BETWEEN PONDS 3 & 4 AND RELATED APPURTENANCES AS DESCRIBED AND INDICATED, HEREBY THIS MAKES THESE SEVERAL STATEMENTS RELATIVE AND OFFERS THOSE DRAWINGS AND STATEMENTS FOR ACCEPTANCE AND FILING IN COMPLIANCE WITH THE LAWS OF THE STATE OF NEW MEXICO.

THE PROPOSED LINED DECANT WATER POND (DAM) HAS THE FOLLOWING PROPERTIES: HEIGHT ABOVE FOUNDATION IS APPROXIMATELY 10 TO 14 FEET. THE WIDTH AT THE BASE IS 90 FEET FOR THE NEW EMBANKMENT. THE CREST LENGTH IS APPROXIMATELY 5,740 FEET, AND THE CREST WIDTH IS 30 FEET. SLOPE OF UPSTREAM FACE IS 3 HORIZONTAL TO 1 VERTICAL; SLOPE OF DOWNSTREAM FACE IS 2 HORIZONTAL TO 1 VERTICAL.

THE DAM SHOULD BE CLASSIFIED BY THE STATE AS AN INTERMEDIATE SIZE DAM WITH SIGNIFICANT HAZARD POTENTIAL.

THE DAM WILL BE ROLLED EARTH FILL AND PLACED ON TOP OF THE EXISTING DAMS, AND THE IMPOUNDED FLY ASH.

1	5-14-04	AS-BUILT	PRATT	PSS	BRC	JDM	04-6379	
NO.	DATE	REVISION	DWN	CHD	EXD	RWVD	APVD	W.A.
FOUR CORNERS COMMON ASH HANDLING SYSTEM LINED DECANT WATER POND FILING SHEET								
SCALE: NONE DATE: 1-14-03								
DWN	PRATT	APPROVED					W A	
CHD		JOHN D. MITCHELL ENGINEERING SUPERVISOR					04-6379	
EXD	BRC	UNIT	DISC	TYPE	SYS	NUMBER	SHEET	
RWVD		FC	C	41	ADS	150793	1	

THIS DRAWING IS CONFIDENTIAL AND SHALL NOT BE USED OR REPRODUCED IN ANY PART WITHOUT WRITTEN CONSENT OF PINNACLE WEST CAPITAL CORPORATION.

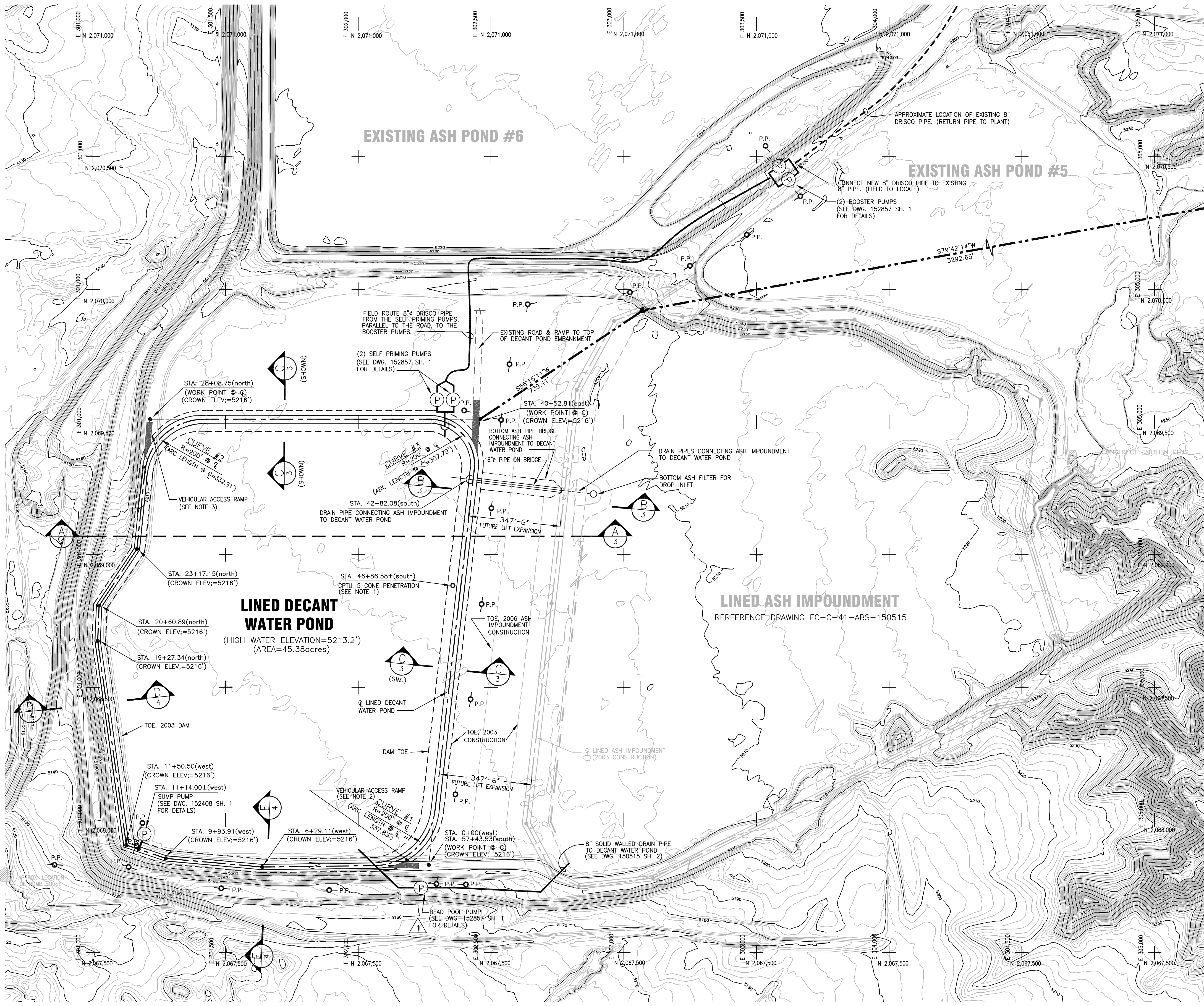

- NOTES:**
1. FOR CONE PENETRATION TESTING RESULTS, SEE REPORT PREPARED BY "CONETEC INC." DATED OCT. 14, 2002.
 2. CONSTRUCT A 20' WIDE CLAY VEHICULAR RAMP FROM CROWN OF THE EMBANKMENT (ELEV. 5216) DOWN TO EXISTING GRADE (ELEV. 5210). SLOPE TO BE 10:1 AND A TOTAL LENGTH OF 60'±.
 3. CONSTRUCT A 20' WIDE CLAY VEHICULAR RAMP FROM CROWN OF THE EMBANKMENT (ELEV. 5216) DOWN TO EXISTING GRADE (ELEV. 5208). SLOPE TO BE 10:1 AND A TOTAL LENGTH OF 80'±.
 4. INSTALL 1"Ø HOLES IN PRIMARY LINER TO PROVIDE VENTILATION. SPACE HOLES AT 100' CENTERS.

SEE DETAIL 152408 SH. 1A

STATION NO.	NORTHING	EASTING
STA. 0+00	N2,067,830.82	E302,265.35
STA. 6+29.11	N2,067,823.05	E301,637.64
STA. 9+93.91	N2,067,855.53	E301,274.29
STA. 11+50.50	N2,067,905.57	E301,125.91
STA. 19+27.34	N2,068,674.86	E301,017.82
STA. 20+60.89	N2,068,808.30	E301,023.32
STA. 23+17.15	N2,069,021.28	E301,165.82
STA. 28+08.75	N2,069,510.48	E301,215.63
STA. 40+52.81	N2,069,510.48	E302,458.41
STA. 42+82.08	N2,069,281.85	E302,432.20
STA. 57+43.53	N2,067,830.82	E302,265.35

STATION POINTS
(TIED TO STATE COORDINATES)

PUMP NAME	NORTHING	EASTING
DEAD POOL PUMP	N2,067,745.00±	E302,260.00±
SELF-PRIMING PUMPS	N2,069,586.00±	E302,330.00±
BOOSTER PUMPS	N2,070,435.00±	E303,600.00±

PUMPS' COORDINATE POINTS
(TIED TO STATE COORDINATES)

NOTE:
THESE COORDINATES REPRESENT THE APPROXIMATE LOCATION OF THE PUMPS. THE FIELD IS TO DETERMINE THE EXACT LOCATION.

REFERENCE:
FLOWN BY "AERIAL MAPPING COMPANY, INC." ON JULY 19, 2001
3141 WEST CLARENDON AVENUE
PHOENIX, ARIZONA 85017

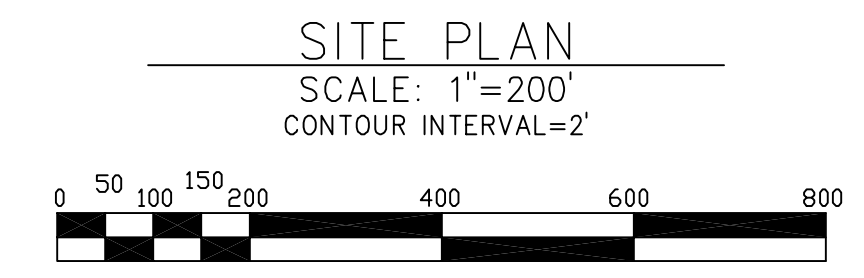
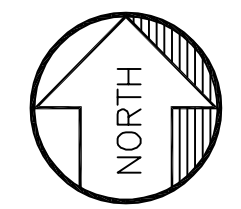
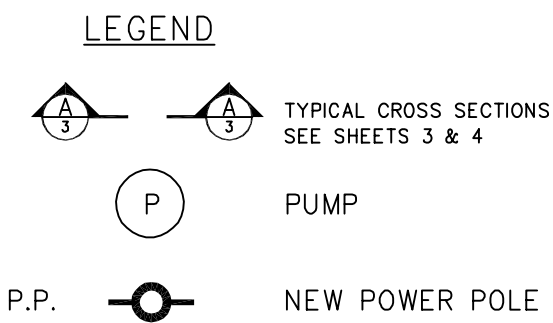

DRAINAGE AREA DRAWING, SEE E-150793 SHEET #6

DATUM INFORMATION

CONTROL POINTS:
HV-53
SOUTHERN CALIFORNIA EDISON (SCE) BRASS CAP
NORTHING: N2,070,519.859
EASTING: E306,365.846
ELEVATION: 5328.150'

NEW MEXICO STATE PLANE
TRANSVERSE MERCATOR-WEST ZONE
N.A.D. 1927



1	5-14-04	AS-BUILT	PRATT	PSS	BRC	JDM	04-6379	
NO.	DATE	REVISION	DWN	CHD	EXD	RWVD	APVD	W.A.
FOUR CORNERS COMMON ASH HANDLING SYSTEM LINED DECANT WATER POND SITE PLAN								
						SCALE NOTED _____ DATE 1-14-03		
DWN	PRATT	APPROVED				W A		
CHD		JOHN D. MITCHELL ENGINEERING SUPERVISOR				04-6379		
EXD	BRC	UNIT	DISC	TYPE	SYS	NUMBER	SHEET	REV
RWVD		FC	C	17	ADS	150793	2	1

THIS DRAWING IS CONFIDENTIAL AND SHALL NOT BE USED OR REPRODUCED IN ANY PART WITHOUT WRITTEN CONSENT OF PINNACLE WEST CAPITAL CORPORATION.

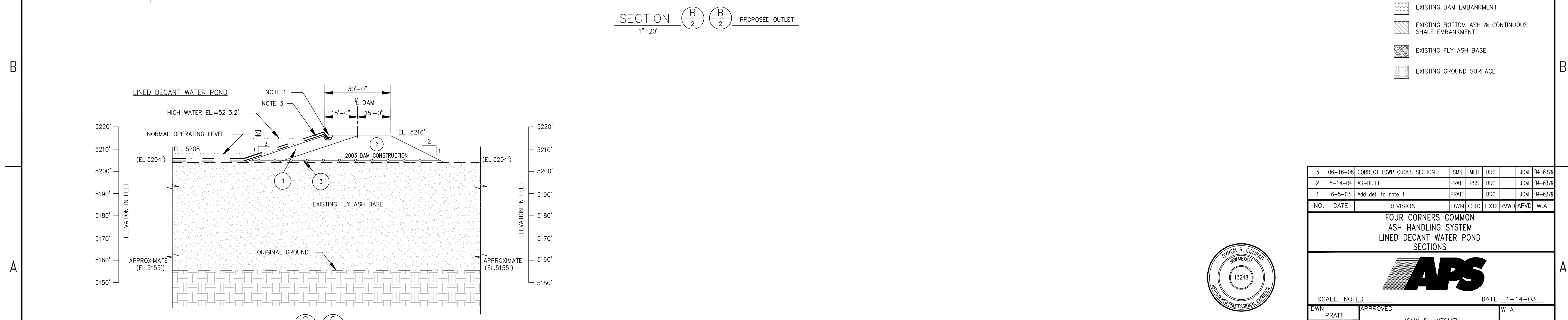
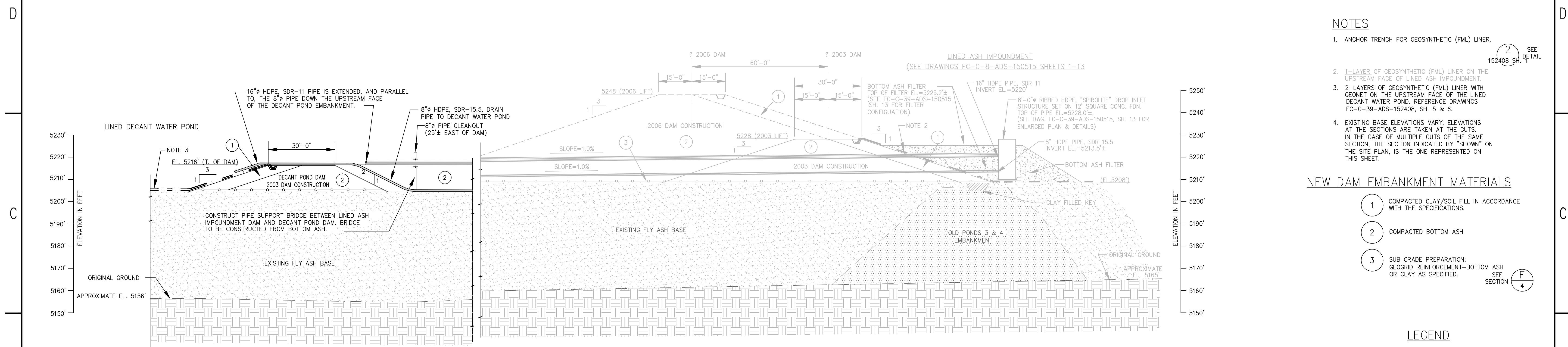
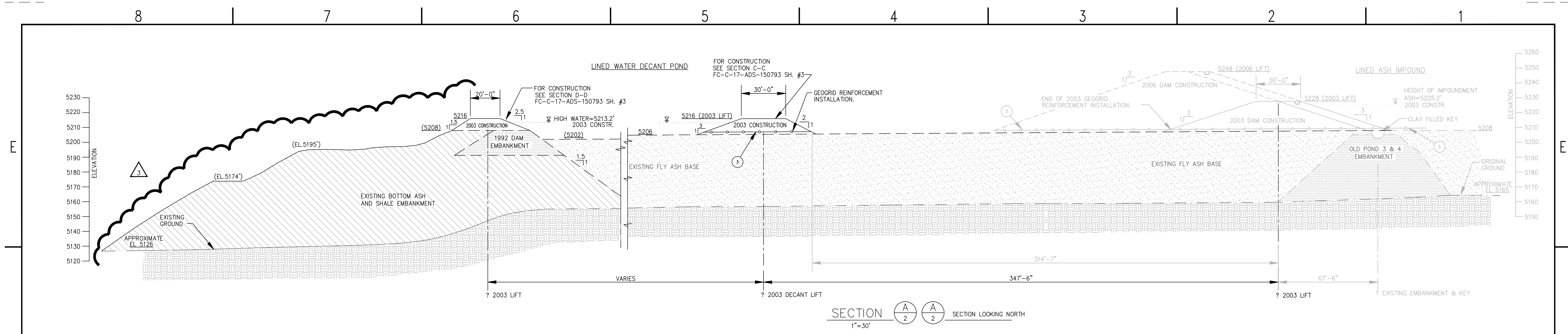

NOTES

- ANCHOR TRENCH FOR GEOSYNTHETIC (FML) LINER. SEE DETAIL 152406 SH. #2
- LAYER OF GEOSYNTHETIC (FML) LINER ON THE UPSTREAM FACE OF LINED ASH IMPOUNDMENT.
- LAYERS OF GEOSYNTHETIC (FML) LINER WITH GEONET ON THE UPSTREAM FACE OF THE LINED DECANT WATER POND. REFERENCE DRAWINGS FC-C-39-ADS-152406, SH. 5 & 6.
- EXISTING BASE ELEVATIONS VARY. ELEVATIONS AT THE SECTIONS ARE TAKEN AT THE CUTS. IN THE CASE OF MULTIPLE CUTS OF THE SAME SECTION, THE SECTION INDICATED BY 'SHOWN' ON THE SITE PLAN, IS THE ONE REPRESENTED ON THIS SHEET.

NEW DAM EMBANKMENT MATERIALS

- COMPACTED CLAY/SOIL FILL IN ACCORDANCE WITH THE SPECIFICATIONS.
- COMPACTED BOTTOM ASH
- SUB GRADE PREPARATION: GEOGRID REINFORCEMENT-BOTTOM ASH OR CLAY AS SPECIFIED. SEE SECTION F-4

LEGEND

- EXISTING DAM EMBANKMENT
- EXISTING BOTTOM ASH & CONTINUOUS SHALE EMBANKMENT
- EXISTING FLY ASH BASE
- EXISTING GROUND SURFACE

3	06-16-08	CORRECT LDWP CROSS SECTION	SMS	MLD	BRC	JDM	04-6379	
2	5-14-04	AS-BUILT	PRATT	PSS	BRC	JDM	04-6379	
1	6-5-03	Add det. to note 1	PRATT	BRC	JDM	04-6379		
NO.	DATE	REVISION	DWN	CHD	EXD	RWD	APVD	W.A.
FOUR CORNERS COMMON ASH HANDLING SYSTEM LINED DECANT WATER POND SECTIONS								
SCALE NOTED		DATE		1-14-03				
DWN	PRATT	APPROVED	JOHN D. MITCHELL			W A		
CHD			ENGINEERING SUPERVISOR			04-6379		
EXD	BRC	UNIT	DISC	TYPE	SYS	NUMBER	SHEET	
RWD		FC	C	39	ADS	150793	3	



THIS DRAWING IS CONFIDENTIAL AND SHALL NOT BE USED OR REPRODUCED IN ANY PART WITHOUT WRITTEN CONSENT OF PINNACLE WEST CAPITAL CORPORATION.

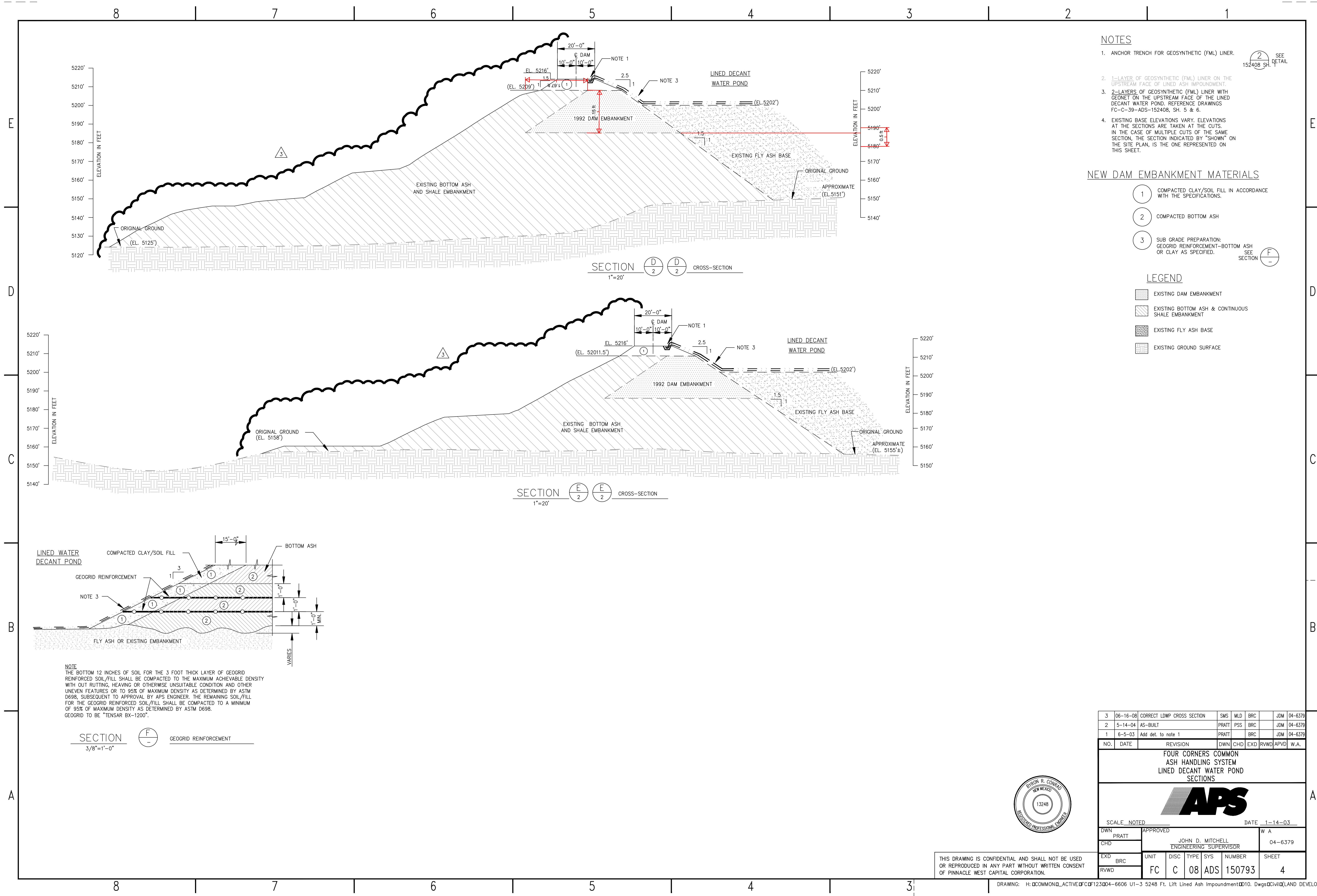

- NOTES**
- ANCHOR TRENCH FOR GEOSYNTHETIC (FML) LINER. SEE 152408 SH1 DETAIL.
 - LAYER OF GEOSYNTHETIC (FML) LINER ON THE UPSTREAM FACE OF LINED ASH IMPONDEMENT.
 - 2 LAYERS OF GEOSYNTHETIC (FML) LINER WITH GEONET ON THE UPSTREAM FACE OF THE LINED DECANT WATER POND. REFERENCE DRAWINGS FC-C-39-ADS-152408, SH. 5 & 6.
 - EXISTING BASE ELEVATIONS VARY. ELEVATIONS AT THE SECTIONS ARE TAKEN AT THE CUTS. IN THE CASE OF MULTIPLE CUTS OF THE SAME SECTION, THE SECTION INDICATED BY "SHOWN" ON THE SITE PLAN, IS THE ONE REPRESENTED ON THIS SHEET.

- NEW DAM EMBANKMENT MATERIALS**
- COMPACTED CLAY/SOIL FILL IN ACCORDANCE WITH THE SPECIFICATIONS.
 - COMPACTED BOTTOM ASH
 - SUB GRADE PREPARATION: GEGRID REINFORCEMENT-BOTTOM ASH OR CLAY AS SPECIFIED. SEE SECTION F-F.

- LEGEND**
- EXISTING DAM EMBANKMENT
 - EXISTING BOTTOM ASH & CONTINUOUS SHALE EMBANKMENT
 - EXISTING FLY ASH BASE
 - EXISTING GROUND SURFACE

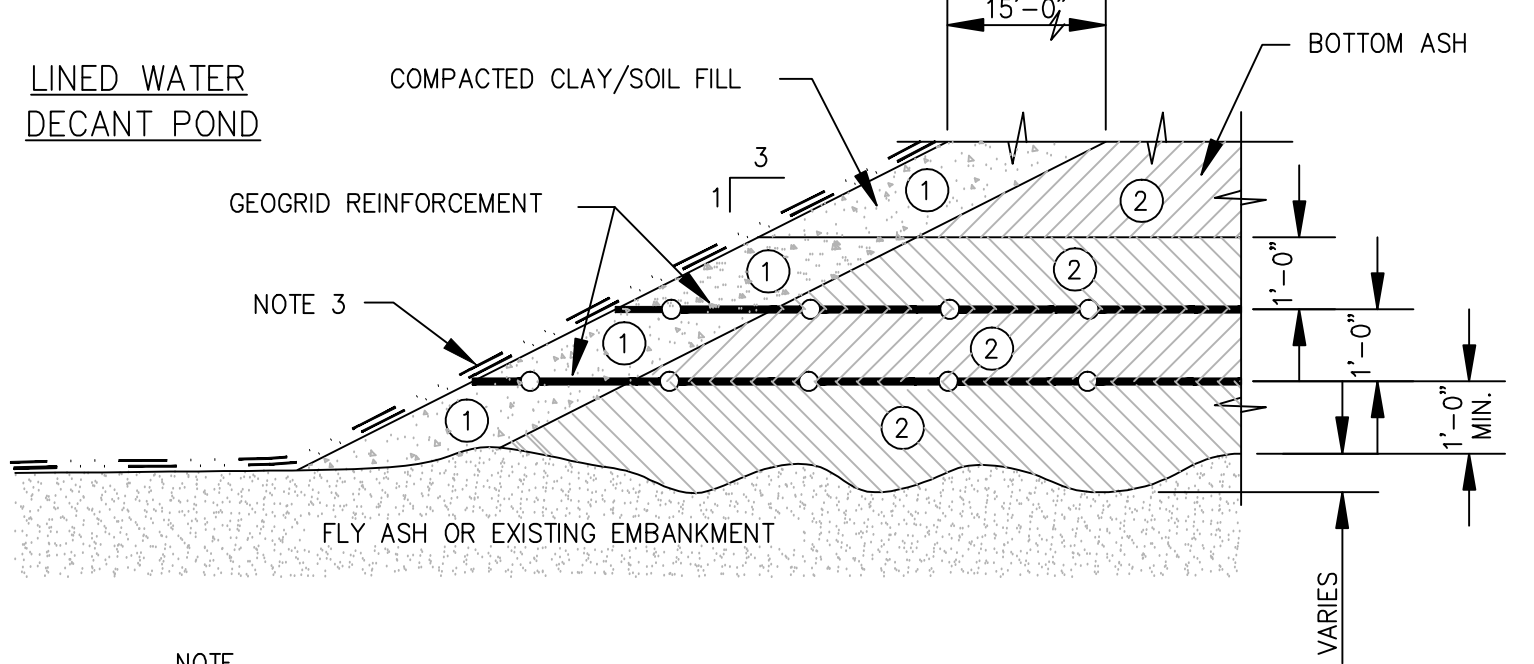

NOTE
 THE BOTTOM 12 INCHES OF SOIL FOR THE 3 FOOT THICK LAYER OF GEGRID REINFORCED SOIL/FILL SHALL BE COMPACTED TO THE MAXIMUM ACHIEVABLE DENSITY WITH OUT RUTTING, HEAVING OR OTHERWISE UNSUITABLE CONDITION AND OTHER UNEVEN FEATURES OR TO 95% OF MAXIMUM DENSITY AS DETERMINED BY ASTM D698, SUBSEQUENT TO APPROVAL BY APS ENGINEER. THE REMAINING SOIL/FILL FOR THE GEGRID REINFORCED SOIL/FILL SHALL BE COMPACTED TO A MINIMUM OF 95% OF MAXIMUM DENSITY AS DETERMINED BY ASTM D698. GEGRID TO BE "TENSAR BX-1200".

SECTION F-F
 3/8"=1'-0" GEGRID REINFORCEMENT

3	06-16-08	CORRECT LDWP CROSS SECTION	SMS	MLD	BRC	JDM	04-6379	
2	5-14-04	AS-BUILT	PRATT	PSS	BRC	JDM	04-6379	
1	6-5-03	Add det. to note 1	PRATT	BRC	BRC	JDM	04-6379	
NO.	DATE	REVISION	DWN	CHD	EXD	RWD	APVD	W.A.
FOUR CORNERS COMMON ASH HANDLING SYSTEM LINED DECANT WATER POND SECTIONS								
SCALE NOTED			DATE 1-14-03					
DWN	APPROVED		W A					
CHD	PRATT	JOHN D. MITCHELL		ENGINEERING SUPERVISOR		04-6379		
EXD	BRC	UNIT	DISC	TYPE	SYS	NUMBER	SHEET	
RWD		FC	C	08	ADS	150793	4	

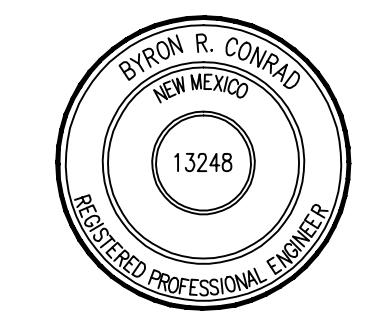

THIS DRAWING IS CONFIDENTIAL AND SHALL NOT BE USED OR REPRODUCED IN ANY PART WITHOUT WRITTEN CONSENT OF PINNACLE WEST CAPITAL CORPORATION.

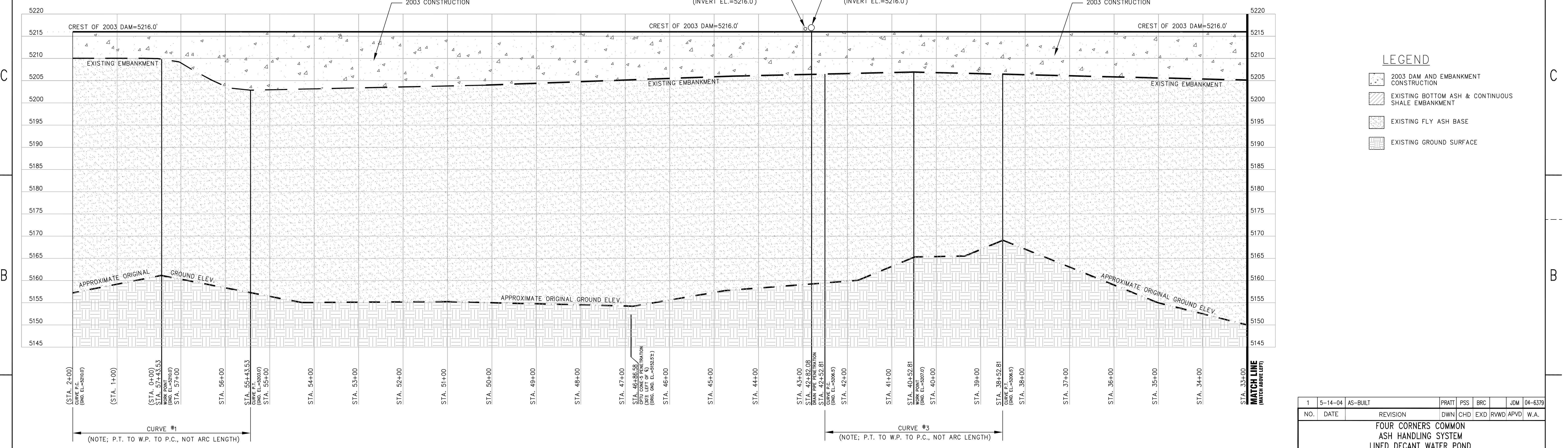
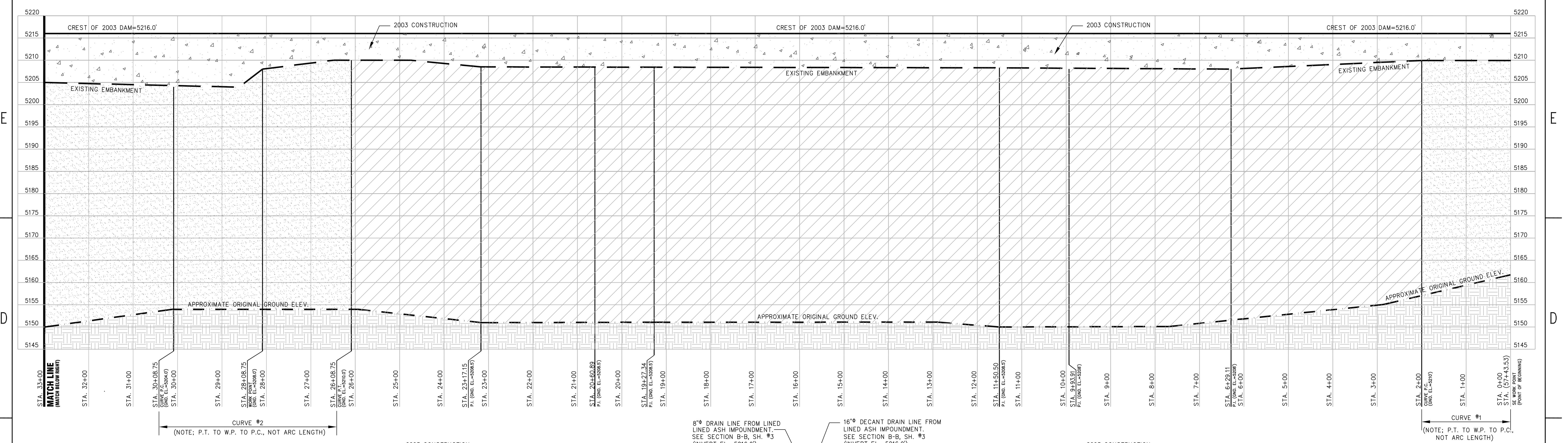

- LEGEND**
- 2003 DAM AND EMBANKMENT CONSTRUCTION
 - EXISTING BOTTOM ASH & CONTINUOUS SHALE EMBANKMENT
 - EXISTING FLY ASH BASE
 - EXISTING GROUND SURFACE

LONGITUDINAL PROFILE
 VERT. 1"=10'
 HORIZ. 1"=100'
 SEE SHEET #2 FOR PLAN

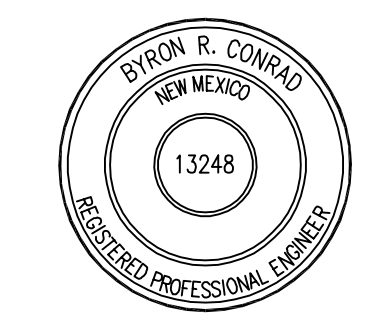

1	5-14-04	AS-BUILT	PRATT	PSS	BRC	JDM	04-6379	
NO.	DATE	REVISION	DWN	CHD	EXD	RWVD	APVD	W.A.
FOUR CORNERS COMMON ASH HANDLING SYSTEM LINED DECANT WATER POND LONGITUDINAL PROFILE @ CENTER LINE								
SCALE NOTED							DATE	1-14-03
DWN	PRATT	APPROVED				W A		
CHD		JOHN D. MITCHELL ENGINEERING SUPERVISOR				04-6379		
EXD	BRC	UNIT	DISC	TYPE	SYS	NUMBER	SHEET	
RWVD		FC	C	39	ADS	150793	5	

THIS DRAWING IS CONFIDENTIAL AND SHALL NOT BE USED OR REPRODUCED IN ANY PART WITHOUT WRITTEN CONSENT OF PINNACLE WEST CAPITAL CORPORATION.

E

D

C

B

A

E

D

C

B

A

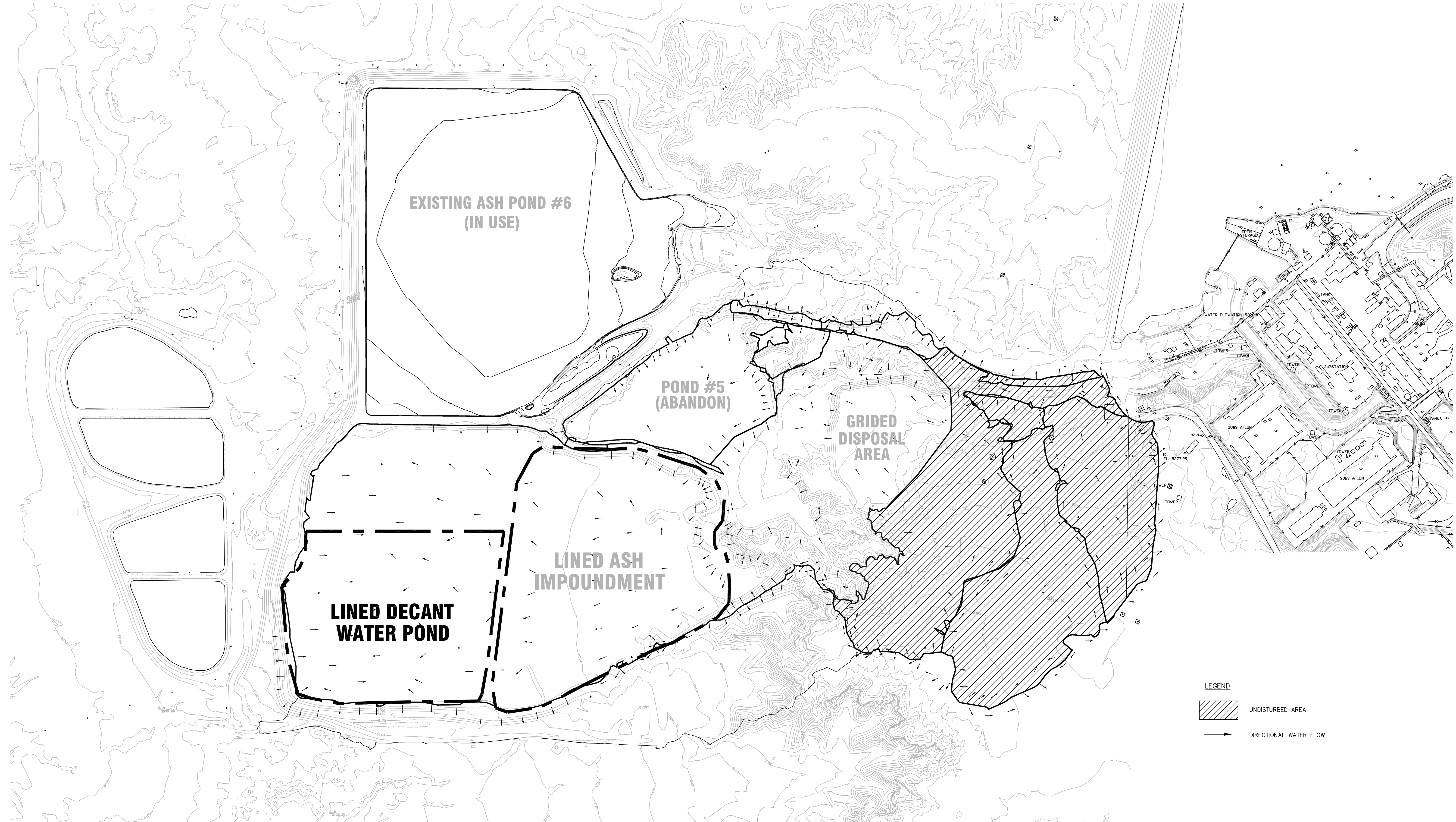

LEGEND

UNDISTURBED AREA

DIRECTIONAL WATER FLOW

REFERENCE:
 FLOWN BY "AERIAL MAPPING COMPANY, INC." ON JULY 19, 2001
 3141 WEST CLARENDON AVENUE
 PHOENIX, ARIZONA 85017

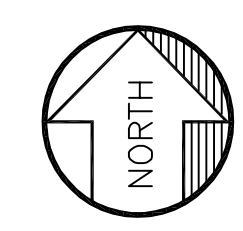

DRAINAGE PLAN
 SCALE: 1"=200'
 CONTOUR INTERVAL=2'

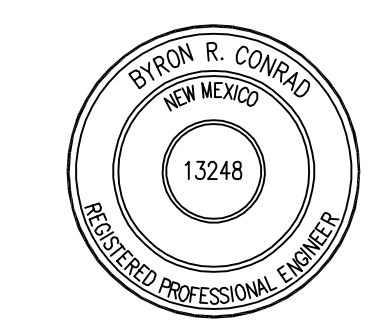

1	5-14-04	AS-BUILT	PRATT	PSS	BRC	JDM	04-6379	
NO.	DATE	REVISION	DWN	CHD	EXD	RWVD	APVD	W.A.

**FOUR CORNERS COMMON
 ASH HANDLING SYSTEM
 LINED DECANT WATER POND
 DRAINAGE MAP**



SCALE: 1"=300' DATE: 1-14-03

DWN	PRATT	APPROVED					W A
CHD			JOHN D. MITCHELL ENGINEERING SUPERVISOR				04-6379

EXD	BRC	UNIT	DISC	TYPE	SYS	NUMBER	SHEET
RWVD		FC	C	16	ADS	150793	6

THIS DRAWING IS CONFIDENTIAL AND SHALL NOT BE USED OR REPRODUCED IN ANY PART WITHOUT WRITTEN CONSENT OF PINNACLE WEST CAPITAL CORPORATION.

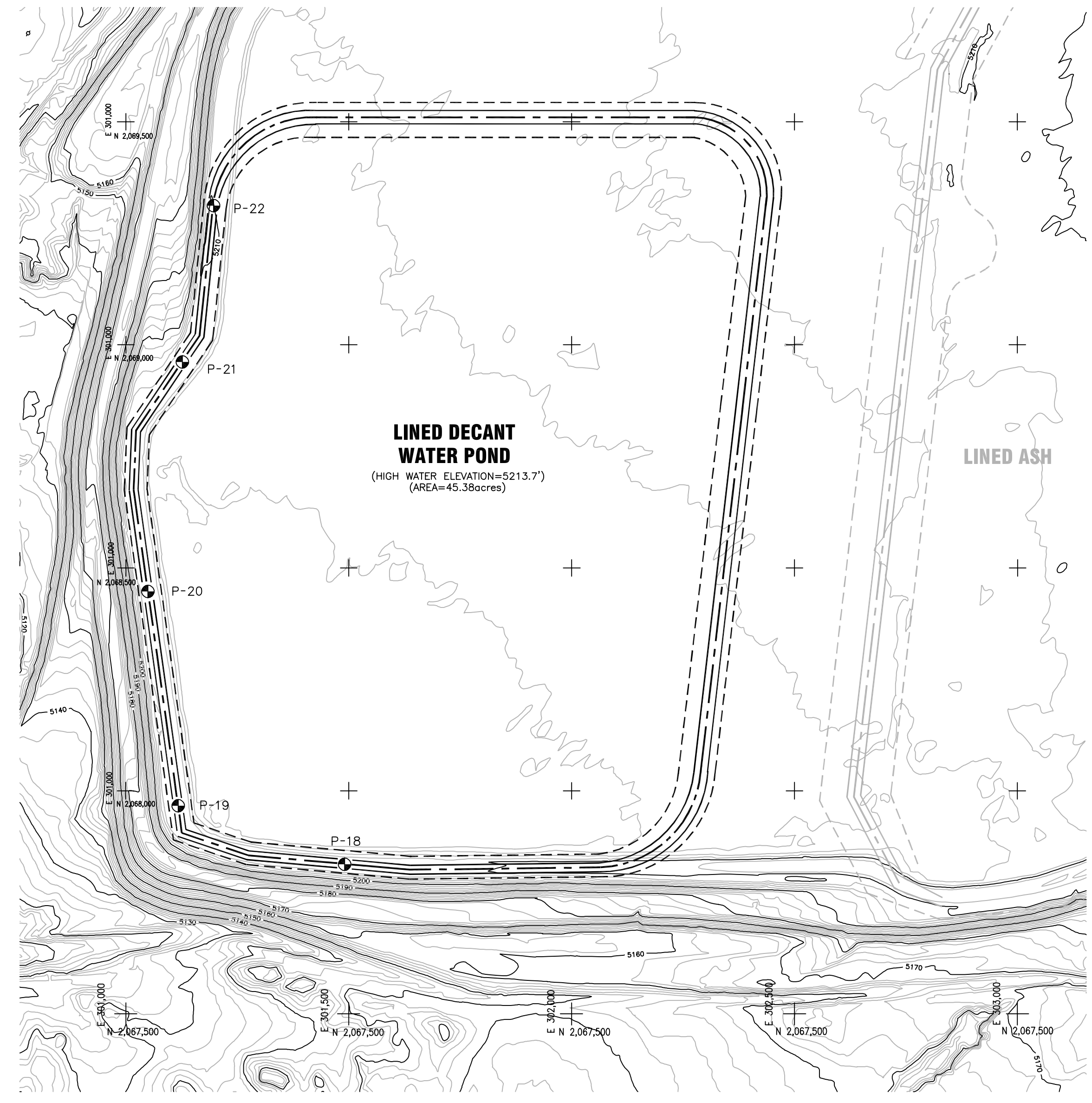

LEGEND
 ● P-18 PIEZOMETER LOCATION

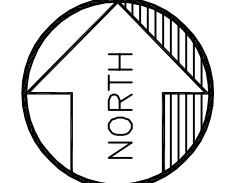

PIEZOMETER LOCATIONS
 1"=200'
 CONTOUR INTERVAL=2'

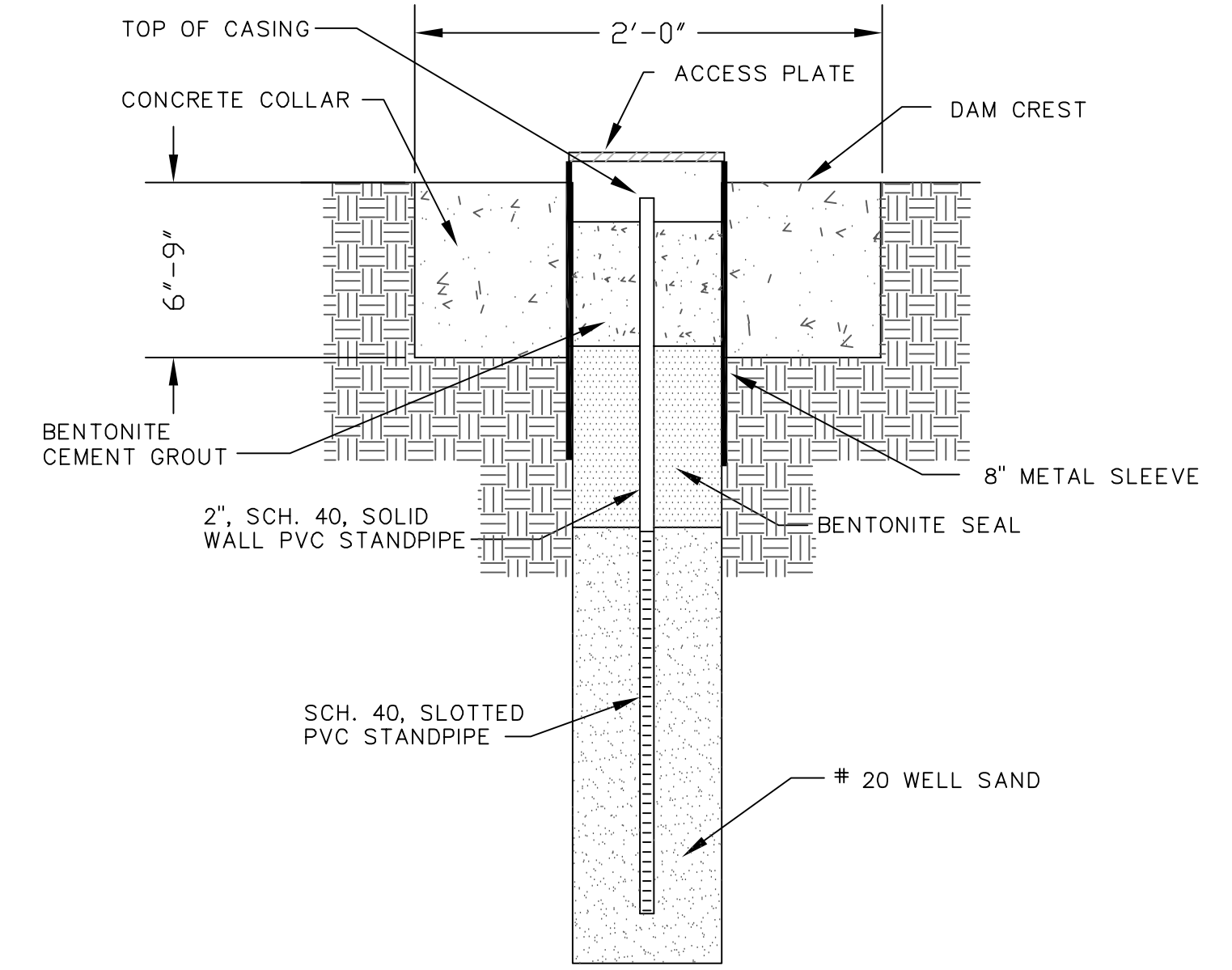

DETAIL
 NONE

1
 -

TYP. STANDPIPE PIEZOMETER

PIEZOMETER POINT NO.	NORTHING	EASTING	STATION	TOP OF CASING ELEVATION
P-18	N2,067,835.40	E301,490.20	STA. 7+77.0	5216.48
P-19	N2,067,966.32	E301,117.46	STA. 12+12.0	5216.02
P-20	N2,068,446.89	E301,049.81	STA. 17+00.0	5216.10
P-21	N2,068,961.57	E301,126.67	STA. 22+46.0	5216.28
P-22	N2,068,812.04	E301,196.54	STA. 26+08.0	5217.07

PIEZOMETER POINTS
 (TIED TO STATE COORDINATES)



1	5-14-04	AS-BUILT	PRATT	PSS	BRC	JDM	04-6379	
NO.	DATE	REVISION	DWN	CHD	EXD	RWVD	APVD	W.A.
FOUR CORNERS COMMON ASH HANDLING SYSTEM LINED DECANT WATER POND PIEZOMETER LOCATIONS								
								
SCALE NOTED							DATE 1-14-03	
DWN	PRATT	APPROVED					W A	
CHD		JOHN D. MITCHELL ENGINEERING SUPERVISOR					04-6379	
EXD	BRC	UNIT	DISC	TYPE	SYS	NUMBER	SHEET	REV
RWVD		FC	C	17	ADS	150793	7	1

THIS DRAWING IS CONFIDENTIAL AND SHALL NOT BE USED OR REPRODUCED IN ANY PART WITHOUT WRITTEN CONSENT OF PINNACLE WEST CAPITAL CORPORATION.

Appendix B. Safety Factor Calculation

Quality - It's Good Business		QMS Form 3-4 (MM) Date: September 2014		
IE QMS		Check and Review Record		
Project Name	Four Corners CCR Structural Integrity Assessments	Client Name	APS	
Project Location	Four Corners Power Plant	PM Name	Frances Ackerman, R.G., P.E.	
Project Number / Office Code	60445844	PIC Name	Alexander Gourlay, P.E.	
Type	<input type="checkbox"/> Detail Check	<input type="checkbox"/> Coordination Review	<input type="checkbox"/> Constructability Review	<input type="checkbox"/> Bidability Review
	<input checked="" type="checkbox"/> Independent Technical Review (ITR)	<input type="checkbox"/> Calculation Check (can also use QMS Form 3-3)	<input type="checkbox"/> Other:	For Subconsultant, Client, or Third-Party Information Review, use Form 3-11.
(This section is to be completed by the Project Manager or the PM's Designee.)				
Identifying Information	Individual Assigned:	Lee Wright, P.E.	Comments Required by:	
	Work Product Originator:	Jed Stoken, P.E.	Title of Work Product:	Lined Decant Water Pond Safety Factor Assessment
	Review Scope			
	<input type="checkbox"/> Technical edit for elements such as grammar, punctuation and formatting.	<input type="checkbox"/> Completion of review of client and third-party information.	<input checked="" type="checkbox"/> Basis and validity of conclusion / recommendation.	
	<input type="checkbox"/> Detail Check of calculations and graphics.	<input checked="" type="checkbox"/> Soundness of approach/design.	<input checked="" type="checkbox"/> Organization, clarity and completeness.	
	<input type="checkbox"/> Completion of Detail Check	<input checked="" type="checkbox"/> Conformance with standards	<input type="checkbox"/> Application of Statements of Limitations.	
	<input type="checkbox"/> Other:			
Project Manager (or Designee) Signature		Date		
Comments	Select:			
	<input type="checkbox"/> Checker / Reviewer has no comments.			
	or			
	<input checked="" type="checkbox"/> Comments have been provided on:			
	<input checked="" type="checkbox"/> Marked directly on work product (electronically or on hard copy).			
	<input type="checkbox"/> Comment and Disposition Record (QMS Form 3-5).			
	<input type="checkbox"/> Other:			
Checker / Reviewer Signature		Date		
Verification	(Note: Reviews and Checks are often iterative, requiring multiple rounds to verify accuracy and completeness of the work product. This section is to be completed by the Checker/Reviewer <u>after</u> verification of comment incorporation to include subsequent or new comments.)			
	Select:			
	<input checked="" type="checkbox"/> Checker / Reviewer has verified that comments have been adequately addressed. There are no outstanding issues.			
	or			
	<input type="checkbox"/> Checker / Reviewer has verified that comments have been adequately addressed. Any unresolved issues have been submitted to the Project Manager or Designee for final resolution.			
	and			
	<input checked="" type="checkbox"/> Checker / Reviewer confirms that the work product Check / Review is complete.			
Checker / Reviewer Signature		Date		

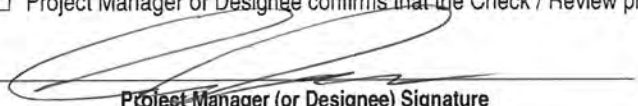
URS Quality - It's Good Business 		QMS Form 3-4 (MM)
		Date: September 2014
IE QMS		Check and Review Record
Approval	<i>(This section is to be completed by the Project Manager or PM's designee.)</i>	
	<input type="checkbox"/> Project Manager or Designee confirms that the Check / Review process has been followed.	
	 Project Manager (or Designee) Signature	<u>8/12/16</u> Date
DISTRIBUTION	Project Central File – Quality File Folder Other – Specify:	

ANALYSIS CALCULATION				
Calculation Title: Factor of Safety Assessment	CCR Unit: Lined Decant Water Pond	Project No: 60445844	Date: 7/1/16	Page No: Page 1 of 15

TABLE OF CONTENTS

1 Introduction 2

2 Analysis Criteria..... 2

3 Analysis Inputs 2

4 Assumptions..... 3

5 Safety Factor Calculations 4

 5.1 Critical Stability Cross-Sections 4

 5.2 Material Properties 6

 5.3 Embankment Pore Pressure Distribution 6

 5.4 Embankment Loading Conditions 7

6 Analysis Results and Conclusions 12

7 References 13

8 Attachments 14

Figures

- Figure 1 Slope Stability Cross Section Locations Along the LDWP
- Figure 2 Table 20.3-1 Site Classification from ASCE 7-10 (2013)
- Figure 3 Table 1613.3.3(1) from the IBC (2015)
- Figure 4 Variations of Peak Transverse Crest Acceleration v. Peak Transverse Base Acceleration Based on Holzer (1998)
- Figure 5 Variation of “Maximum Acceleration Ratio” with Depth of Sliding Mass after Makdisi and Seed (1977)

Tables

- Table 1 Material Properties Used for the Safety Factor Assessment
- Table 2 Safety Factor Results

ANALYSIS CALCULATION				
Calculation Title: Factor of Safety Assessment	CCR Unit: Lined Decant Water Pond	Project No: 60445844	Date: 7/1/16	Page No: Page 2 of 15

1 INTRODUCTION

The purpose of this calculation is to document safety factors for the Coal Combustion Residual (CCR) surface impoundments at Arizona Public Service's (APS) Four Corners Power Plant (FCPP) near Farmington, New Mexico. Specifically, the Lined Decant Water Pond (LDWP) is the subject of this assessment.

2 ANALYSIS CRITERIA

The analyses were performed to meet the regulations set forth in the United States Environmental Protection Agency (EPA) 40 CFR Parts 257.73(e) Structural Integrity Criteria for Existing CCR Impoundments (the Rule) (EPA 2015). The Rule requires safety factor assessments for units containing coal combustion residuals. The safety factors for various embankment loading and tailwater conditions must meet the values outlined in the Rule. For the CWTP, the following safety factors must be met:

- Long-term, maximum storage pool FS = 1.50
- Maximum surcharge pool FS = 1.40
- Seismic loading FS = 1.00
- Liquefaction loading FS = 1.20 (only for sites with liquefiable soils)

3 ANALYSIS INPUTS

The following inputs were used in the analysis:

- The geometry for the cross sections was based on site topography of the LDWP presented in the as-built drawing set for the LDWP (APS, 2008). This includes cross sections of the West and South Embankments shown in Drawing Sections D and E, respectively.
- The subsurface stratigraphy was based on the as-built drawing set of the LDWP (APS Drawing Number 150793) and boring logs for piezometers P-18 and P-20, installed by ConeTec on the crest.

ANALYSIS CALCULATION				
Calculation Title: Factor of Safety Assessment	CCR Unit: Lined Decant Water Pond	Project No: 60445844	Date: 7/1/16	Page No: Page 3 of 15

- The safety factor calculations were performed using the software program SLOPE/W, commercially available through GEO-SLOPE International, Ltd. (GEO-SLOPE International 2012).
- Material properties used in the safety factor assessment were based on previously reported material properties and material properties developed for the Final Geotechnical Analysis Report – Lined Ash Impoundment Embankment (URS, 2004), modified per the Engineering Design Report - Lined Ash Impoundment 5280 Lift (URS, 2012).
- Pore pressure distribution within the embankment was developed from interpretation of water level readings for piezometers installed on and near the embankment. Water level measurements are presented in the annual dam inspection report (AECOM & APS, 2016).
- The maximum operational water level at the southwest corner of the LDWP is 5,209.9 feet, as presented in the Operating and Maintenance Manual (URS, 2014).
- The maximum surcharge water level accounts for containment of the Probable Maximum Flood (PMF) on top of the maximum operational water level in the LDWP. The maximum surcharge water level is 5,214 feet as presented in the Operating and Maintenance Manual (URS, 2014).
- The seismic loading was developed from the deaggregated seismic hazard at the site based on the 2008 United States Geological Survey (USGS) National Earthquake Hazards Reduction Program (NEHRP) Provisions (USGS 2008).

4 ASSUMPTIONS

Assumptions used in this calculation package include:

- The embankment geometry and subsurface conditions have not changed substantially since the initial design calculations were performed.

ANALYSIS CALCULATION				
Calculation Title: Factor of Safety Assessment	CCR Unit: Lined Decant Water Pond	Project No: 60445844	Date: 7/1/16	Page No: Page 4 of 15

- The evaluation considers the stability of the LDWP impoundment as a stand-alone facility and assumes the adjacent, upstream Lined Ash Impoundment LAI is in good working condition and is not applying additional loading to the LDWP.

5 SAFETY FACTOR CALCULATIONS

Safety factor calculations were performed to document minimum factors of safety for loading conditions identified by 40 CFR Section 257.73(e) using the software program SLOPE/W (GEO-SLOPE International, Ltd. 2012). The analyses were performed using Spencer's Method, a limit equilibrium method of slices that satisfies both force and moment equilibrium in addition to incorporating the effects of interslice forces.

5.1 Critical Stability Cross sections

Factors of safety were calculated for critical cross-sections of the LDWP embankment. The critical cross-section is the cross-section that is anticipated to be most susceptible to structural failure for a given loading condition. The critical cross-section thus represents a "most-severe" case. Section locations were selected based on variation in the embankment height and stratigraphic conditions to represent the most-severe case.

The safety factor assessments were performed for three cross-sections along the LAI embankment:

West Embankment (Steepest Upper Slope): The location along the LDWP West Embankment with the steepest upper downstream slope is shown in Figure 1. The West Embankment of the LDWP is about 84 feet high and was constructed on native ground, which is composed of weathered shale. The downstream slope of the existing embankment is benched. The upper portion of the slope above the bench is inclined at an effective slope of about 1.5H:1V. The West Embankment of the LDWP includes a 15-foot wide compacted clay lining on the upstream slope and crest.

West Embankment (Steepest Overall Slope): The location along the LDWP West Embankment with the steepest overall downstream slope from crest to toe is shown in Figure 1. The downstream slope of the existing embankment is benched to provide an effective overall slope of about 1.9H:1V. The West Embankment of the LDWP includes a 15-foot wide compacted clay lining on the upstream slope and crest.

ANALYSIS CALCULATION				
Calculation Title: Factor of Safety Assessment	CCR Unit: Lined Decant Water Pond	Project No: 60445844	Date: 7/1/16	Page No: Page 5 of 15

South Embankment: The section of the LDWP South Embankment with the steepest downstream slope is shown in Figure 1. The section was modeled from Section E of the Construction Drawings. The South Embankment of the LDWP is about 60 feet high and was constructed on native ground, which comprises weathered shale. The downstream slope of the existing embankment is benched to provide an effective slope of about 2.5H:1V. The South Embankment of the LDWP includes a 15-foot wide compacted clay lining on the upstream slope.



Figure 1 – Slope Stability Cross Section Locations Along the LDWP

ANALYSIS CALCULATION				
Calculation Title:	CCR Unit:	Project No:	Date:	Page No:
Factor of Safety Assessment	Lined Decant Water Pond	60445844	7/1/16	Page 6 of 15

5.2 Material Properties

Material properties used in the safety factor assessment were based on previously reported material properties presented in the Final Geotechnical Analysis Report – Lined Ash Impoundment Embankment (URS, 2004), modified per the Design Report for the 5280 Lift (URS, 2012), and are presented in Table 1 below. Material properties include unit weights and effective shear strength parameters. No additional material properties were developed for this assessment.

Table 1 – Material Properties Used for the Safety Factor Assessment

Material	Total Unit Weight, γ_{sat} (pcf)	Effective Friction Angle (degrees)	Effective Cohesion (psf)
Compacted Bottom Ash	65	34	0
Existing Fly Ash	90	28	0
Compacted Clay (Compacted Shale)	125	20	300
Weathered Shale (Native Ground)	120	30	500

5.3 Embankment Pore Pressure Distribution

Per the preamble to the Rule (EPA 2015), pore-water pressures are estimated from the most reliable of the following: 1) field measurements of pore pressures in existing slopes; 2) past experience and judgment of the Engineer; 3) hydrostatic pressures calculated for the no-flow condition; or 4) steady-state seepage analysis using flow nets or finite element analyses.

The pore pressure distribution in the embankment was estimated using water level measurements in the LDWP piezometers reported in the Four Corners Power Plant Annual CCR Impoundment and Landfill Inspection Report and phreatic surfaces were input into the stability models (AECOM & APS, 2016). The piezometers indicate the phreatic level is below the embankments, within the underlying weathered shale foundation. The regional groundwater level in the vicinity of the LDWP embankment was based on an AECOM 2016 Hydrogeologic assessment of the entire Four Corners Power Plant. Regional water levels below the embankment ranged from approximate elevation (EL) 5,125 feet beneath the South Embankment section to approximate EL 5,110 feet beneath the West Embankment section.

ANALYSIS CALCULATION				
Calculation Title: Factor of Safety Assessment	CCR Unit: Lined Decant Water Pond	Project No: 60445844	Date: 7/1/16	Page No: Page 7 of 15

5.4 Embankment Loading Conditions

Per 40 CFR Section 257.73(e), the following loading conditions were considered for each selected stability cross-section:

- Long-term, maximum storage pool,
- Maximum surcharge pool,
- Seismic loading, and
- Liquefaction loading.

The loading conditions are described below.

Long-Term, Maximum Storage Pool

The maximum storage pool loading is the maximum water level that can be maintained that will result in the full development of a steady-state seepage condition. This loading condition is evaluated to document whether the CCR surface impoundment can withstand a maximum expected pool elevation with full development of saturation in the embankment under long-term loading. The long-term, maximum storage pool was taken as the maximum operating level without PMF as presented in the Operation and Maintenance Manual (URS, 2014). For this analysis, the long-term maximum storage pool of the LDWP was 5,209.9 feet (URS, 2012). Factors of safety were calculated using shear strengths expressed as effective stress with pore water pressures that correspond to the long-term condition.

Maximum Surcharge Pool

The maximum surcharge pool loading is the temporary rise in pool elevation above the maximum storage pool elevation to which the CCR surface impoundment is normally subject under the inflow design flood state. This loading condition is evaluated to document whether the CCR surface impoundment can withstand a short-term impact of a raised pool level on the stability of the downstream slope. The maximum surcharge pool considers a temporary pool elevation that is higher than the maximum storage pool which persists for a length of time sufficient for steady-state seepage or hydrostatic conditions to fully develop within the embankment. The long-term maximum storage pool was taken as the elevation associated with

ANALYSIS CALCULATION				
Calculation Title: Factor of Safety Assessment	CCR Unit: Lined Decant Water Pond	Project No: 60445844	Date: 7/1/16	Page No: Page 8 of 15

the PMF on top of the maximum operating level calculated for the Operation and Maintenance Manual (URS, 2014).

For this analysis, the maximum surcharge pool of the LDWP was 5,214 feet (URS, 2012).

Seismic Loading

Seismic loading was evaluated to document whether the CCR surface impoundment is capable of withstanding a design earthquake without damage to the foundation or embankment that would cause a discharge of its contents. The seismic loading is assessed under seismic loading conditions for a seismic loading event with a 2% probability of exceedance in 50 years, equivalent to a return period of approximately 2,500 years. A pseudostatic analysis was used to represent the seismic loading.

The peak horizontal bedrock acceleration for a Site Class "B" rock, based on the United States Geological Survey (USGS) National Seismic Hazard Map, with a 2% probability of exceedance in 50 years, is 0.05895g, as presented in Attachment A (USGS, 2008). A site classification of "C" was assigned to the site as illustrated in Table 20.3-1 from ASCE 7-10 (ASCE 2013) shown in Figure 2.

Table 20.3-1 Site Classification

Site Class	\bar{v}_s	\bar{N} or \bar{N}_{ch}	\bar{s}_u
A. Hard rock	>5,000 ft/s	NA	NA
B. Rock	2,500 to 5,000 ft/s	NA	NA
C. Very dense soil and soft rock	1,200 to 2,500 ft/s	>50	>2,000 psf
D. Stiff soil	600 to 1,200 ft/s	15 to 50	1,000 to 2,000 psf
E. Soft clay soil	<600 ft/s	<15	<1,000 psf
	Any profile with more than 10 ft of soil having the following characteristics: —Plasticity index $PI > 20$, —Moisture content $w \geq 40\%$, —Undrained shear strength $s_u < 500$ psf		
F. Soils requiring site response analysis in accordance with Section 21.1	See Section 20.3.1		

For SI: 1 ft/s = 0.3048 m/s; 1 lb/ft² = 0.0479 kN/m².

Figure 2. Table 20.3-1 Site Classification from ASCE 7-10 (2013)

ANALYSIS CALCULATION				
Calculation Title: Factor of Safety Assessment	CCR Unit: Lined Decant Water Pond	Project No: 60445844	Date: 7/1/16	Page No: Page 9 of 15

The peak ground acceleration at the ground surface for site class C at the crest is calculated using the following procedure:

$$PGA_{ground\ surface,C} = F_{PGA}(PGA_B)$$

Where:

$PGA_{ground\ surface,C}$ = The peak ground acceleration at the ground surface for site class C

$F_{PGA} = 1.2$ from the International Code Council's 2015 International Building Code (IBC 2015) for site class C with $PGA \leq 0.1$ as shown in Figure 3.

**TABLE 1613.3.3(1)
VALUES OF SITE COEFFICIENT F_s ^a**

SITE CLASS	MAPPED SPECTRAL RESPONSE ACCELERATION AT SHORT PERIOD				
	$S_s \leq 0.25$	$S_s = 0.50$	$S_s = 0.75$	$S_s = 1.00$	$S_s \geq 1.25$
A	0.8	0.8	0.8	0.8	0.8
B	1.0	1.0	1.0	1.0	1.0
C	1.2	1.2	1.1	1.0	1.0
D	1.6	1.4	1.2	1.1	1.0
E	2.5	1.7	1.2	0.9	0.9
F	Note b	Note b	Note b	Note b	Note b

a. Use straight-line interpolation for intermediate values of mapped spectral response acceleration at short period, S_s .

b. Values shall be determined in accordance with Section 11.4.7 of ASCE 7.

Figure 3. Table 1613.3.3(1) from the IBC (2015)

PGA_B = PGA for site class B from the 2008 USGS National Seismic Hazard Map:

$$PGA_{ground\ surface,C} = 1.2(0.05895g)$$

$$PGA_{ground\ surface,C} = 0.0707g$$

$PGA_{ground\ surface,C}$ is then used in the figure below to estimate a peak transverse crest acceleration equal to 0.243g as shown in Figure 4.

ANALYSIS CALCULATION				
Calculation Title: Factor of Safety Assessment	CCR Unit: Lined Decant Water Pond	Project No: 60445844	Date: 7/1/16	Page No: Page 10 of 15

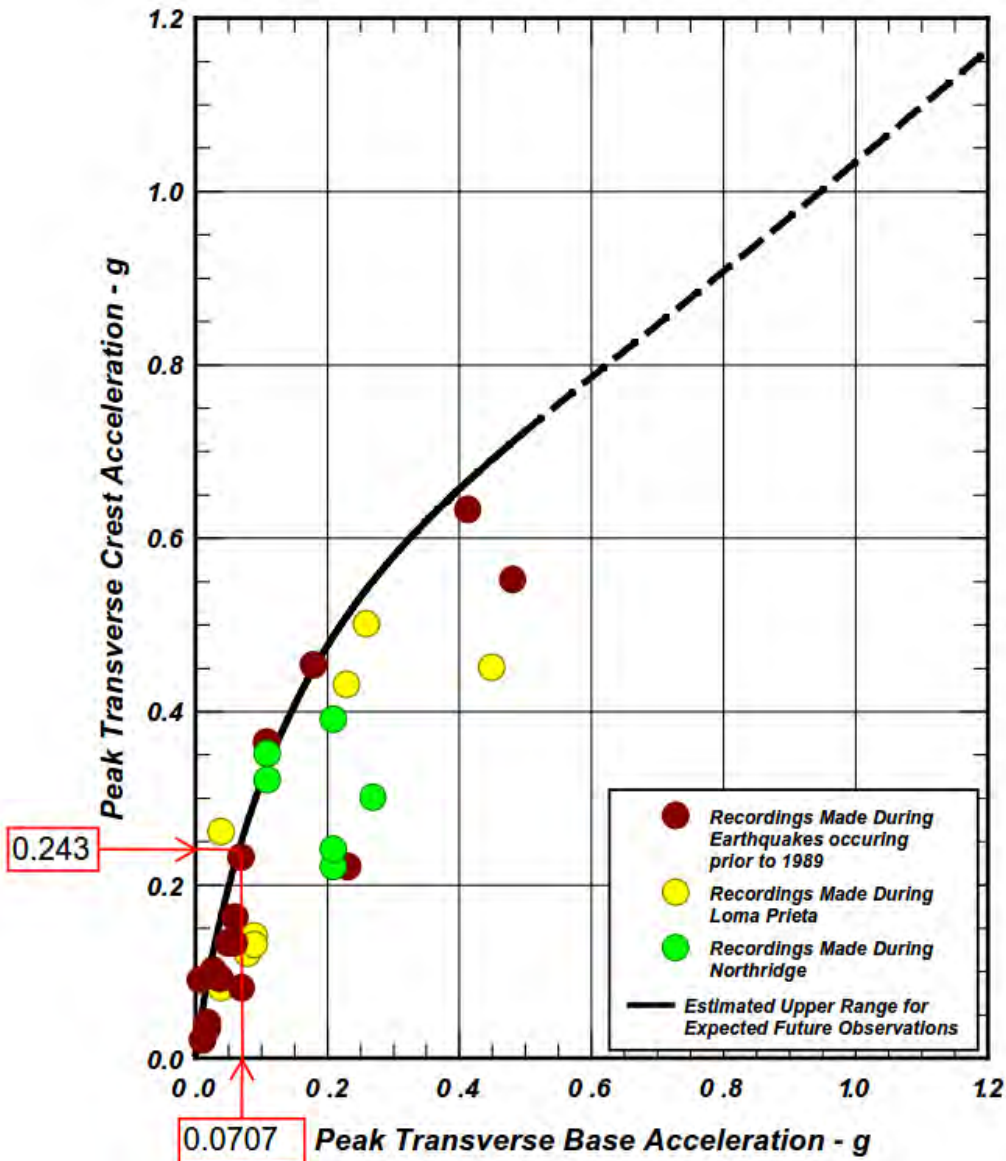

Figure 4. Variations of Peak Transverse Crest Acceleration v. Peak Transverse Base Acceleration Based on Holzer (1998)

Makdisi and Seed (1977) notes that the “maximum acceleration ratio” varies with the depth of the sliding mass relative to the embankment height. Figure 5 (shown below) presents the relationship between maximum acceleration ratio (k_{max}/u_{max}) and depth of sliding mass (y/h). For deep-seated failure surfaces that involve the entire vertical profile of the dam slope and extend from the crest to the toe or below the toe of the embankment into the foundation soils, the acceleration at the crest can be as low as approximately 34 percent of the maximum value:

ANALYSIS CALCULATION				
Calculation Title: Factor of Safety Assessment	CCR Unit: Lined Decant Water Pond	Project No: 60445844	Date: 7/1/16	Page No: Page 11 of 15

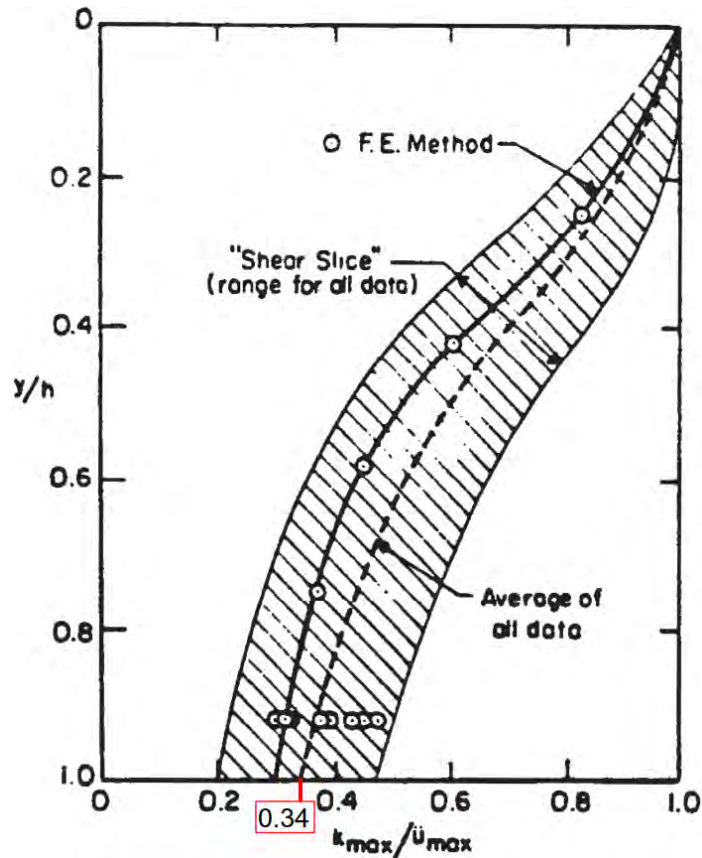

Figure 5. Variation of “Maximum Acceleration Ratio” with Depth of Sliding Mass after Makdisi and Seed (1977)

Therefore:

$$\frac{k_{\max}}{u_{\max}} = 0.34$$

Where: k_{\max} = the maximum average acceleration for the potential sliding mass
 u_{\max} = the maximum crest acceleration

$$k_{\max} = 0.34(u_{\max})$$

$$k_{\max} = 0.34(0.243g)$$

$$k_{\max} = 0.083g$$

The pseudostatic analyses incorporated a horizontal seismic coefficient of 0.083g.

ANALYSIS CALCULATION				
Calculation Title:	CCR Unit:	Project No:	Date:	Page No:
Factor of Safety Assessment	Lined Decant Water Pond	60445844	7/1/16	Page 12 of 15

The water level in the LDWP for the seismic loading analysis was set to EL 5209.9 feet to match the long-term, maximum storage pool. Shear strengths summarized in Table 1 were used to define the strengths for the site materials.

Liquefaction Loading

Liquefaction loading was not evaluated for the LDWP because the compacted bottom ash embankment fill and the clay and shale bedrock materials are not considered to be liquefiable.

6 ANALYSIS RESULTS AND CONCLUSIONS

The results of the safety factor assessment are presented in Attachment B. Table 2 summarizes the results of the safety factor assessment.

Table 2 – Safety Factor Results

Loading Condition	Required Factor of Safety	Calculated Factor of Safety		
		West Embankment (Steepest Upper Slope)	West Embankment (Steepest Overall Slope)	South Embankment
Long-term, maximum storage pool	1.50	1.51	1.58	1.58
Maximum surcharge pool	1.40	1.51	1.58	1.58
Seismic	1.00	1.24	1.29	1.31

The results of the safety factor analyses show that the LDWP Embankments exceed the minimum required factors of safety for the long-term, maximum storage pool; the maximum surcharge pool; and the seismic (pseudostatic) scenarios.

ANALYSIS CALCULATION				
Calculation Title:	CCR Unit:	Project No:	Date:	Page No:
Factor of Safety Assessment	Lined Decant Water Pond	60445844	7/1/16	Page 13 of 15

7 REFERENCES

The following references were used in performing this calculation:

AECOM and Arizona Public Service (APS), 2016, "Four Corners Power Plant Lined Ash Impoundment, Lined Decant Water Pond, Combined Waste Treatment Pond, Upper Retention Sump and Dry Fly Ash Disposal Area Annual CCR Impoundment and Landfill Inspection Report." Prepared for APS Generation Engineering. January.

Arizona Public Service (APS), 2008, "Four Corners Common Ash Handling System Lined Decant Water Pond Section," Drawing No. 150793, Sheet No. 4, Rev. 3, June 16.

ASCE 7-10, 2013, "Minimum Design Loads for Buildings and Other Structures." Third printing, March 15.

GEO-SLOPE International, 2012, GeoStudio 2012, Version 8.15.4.11512, August 2015 Release.

International Code Council (ICC), Inc., 2015, "2015 International Building Code [IBC]." May.

Holzer, Thomas L., 1998, "The Loma Prieta Earthquake of October 17, 1989, Earth Structures and Engineering Characterization of Ground Motion." USGS Professional Paper 1552-D, U.S. Government Printing Office.

Makdisi, F.I. and H. Bolton Seed, 1977, *A Simplified Procedure for Estimating Earthquake-Induced Deformations in Dams and Embankments*. Report No. UCB/EERC-77/19. University of California, Berkeley. August.

United States Environmental Protection Agency (EPA), 2015, *40 CFR Parts 257 and 261 – Hazardous and Solid Waste Management System; Disposal of Coal Combustion Residuals from Electric Utilities; Final Rule*, Federal Register Vol. 80, No. 74. April 17.

United States Geological Survey (USGS), 2008, *2008 Interactive Deaggregations*. <http://geohazards.usgs.gov/deaggint/2008/>, Accessed March 3, 2016.

URS, Inc. 2004, "Final Geotechnical Analysis Report — Lined Ash Impoundment Embankment, Four Corners Generating Facility, Near Farmington, New Mexico," Prepared for Arizona Public Service, April 28.

ANALYSIS CALCULATION				
Calculation Title:	CCR Unit:	Project No:	Date:	Page No:
Factor of Safety Assessment	Lined Decant Water Pond	60445844	7/1/16	Page 14 of 15

URS Corporation, 2012, "Engineering Design Report, Lined Ash Impoundment 5280 Lift, Four Corners Power Plant, San Juan County, New Mexico," Prepared for Arizona Public Service. March.

URS Corporation, 2014, "Operations and Maintenance Manual Lined Ash Impoundment and Lined Decant Water Pond – Four Corners Power Plant," Prepared for Arizona Public Service, May.

8 ATTACHMENTS

ATTACHMENT A USGS Seismic Acceleration

ATTACHMENT B SLOPE/W Output Figures

ATTACHMENT A

USGS Seismic Acceleration

PSH Deaggregation on NEHRP BC rock CWTP 108.475° W, 36.692 N.

Peak Horiz. Ground Accel. ≥ 0.05895 g
 Ann. Exceedance Rate .406E-03. Mean Return Time 2475 years
 Mean (R,M, ϵ_0) 97.1 km, 5.85, 0.32
 Modal (R,M, ϵ_0) = 19.1 km, 4.80, -0.85 (from peak R,M bin)
 Modal (R,M, ϵ^*) = 124.3 km, 6.21, 1 to 2 sigma (from peak R,M, ϵ bin)
 Binning: DeltaR 25. km, deltaM=0.2, Delta ϵ =1.0

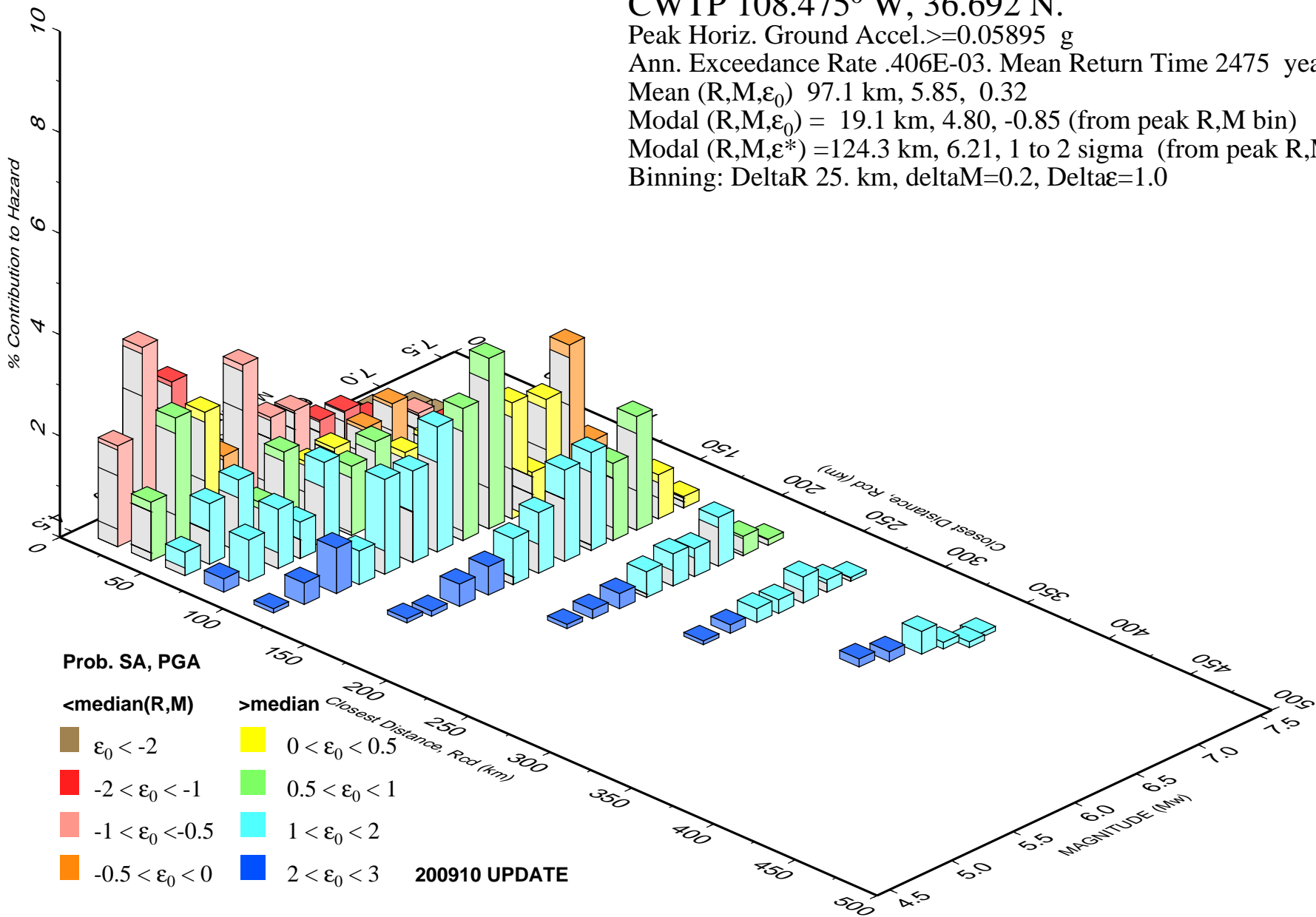

ATTACHMENT B

SLOPE/W Output Figures

**Slope Stability Analysis
West Embankment
Lined Decant Water Pond**

**Four Corners Power Plant
Fruitland, New Mexico
Arizona Public Service**

**1) LDWP West Embankment - Long-Term, Maximum Storage Pool
File Name: West Embankment - Steepest Upper Slope.gsz
Date: 6/3/2016
Method: Spencer**

Factor of Safety: 1.51

Note:
The results of the analysis shown here are based on available subsurface information, laboratory test results, and approximate soil properties. No warranties can be made regarding the continuity of subsurface conditions between the borings.

Material Type:	Unit Weight:	Cohesion:	Friction Angle:
Compacted Clay	125 pcf	300 psf	20 °
Compacted Bottom Ash	65 pcf	0 psf	34 °
Existing Fly Ash	90 pcf	0 psf	28 °
Weathered Shale (Native Ground)	120 pcf	500 psf	30 °

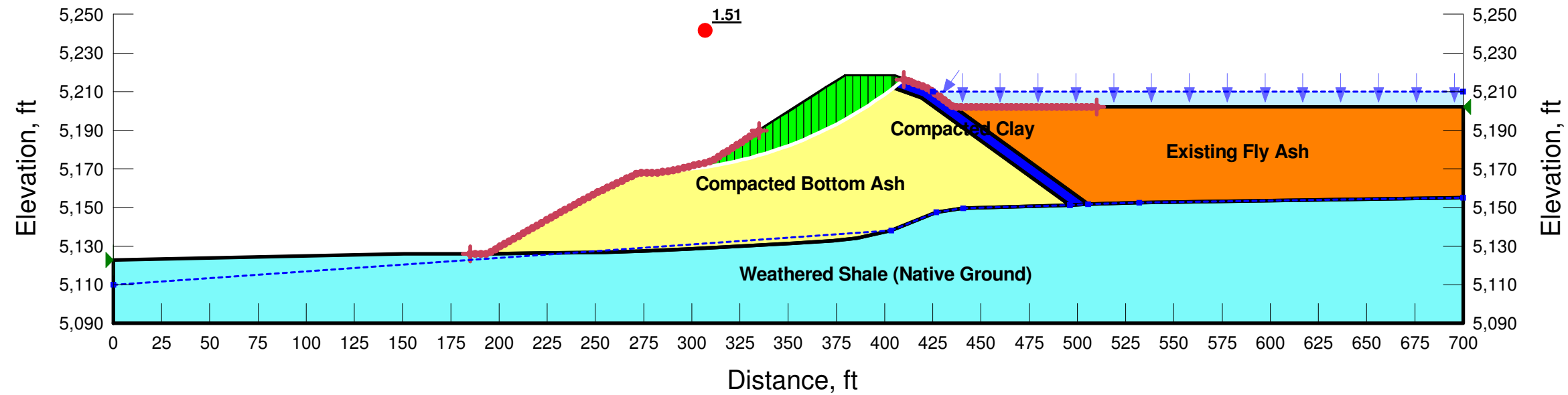

**Slope Stability Analysis
West Embankment
Lined Decant Water Pond**

**Four Corners Power Plant
Fruitland, New Mexico
Arizona Public Service**

**2) LDWP West Embankment - Maximum Surcharge Pool
File Name: West Embankment - Steepest Upper Slope.gsz
Date: 6/3/2016
Method: Spencer**

Factor of Safety: 1.51

Note:
The results of the analysis shown here are based on available subsurface information, laboratory test results, and approximate soil properties. No warranties can be made regarding the continuity of subsurface conditions between the borings.

Material Type:	Unit Weight:	Cohesion:	Friction Angle:
Compacted Clay	125 pcf	300 psf	20 °
Compacted Bottom Ash	65 pcf	0 psf	34 °
Existing Fly Ash	90 pcf	0 psf	28 °
Weathered Shale (Native Ground)	120 pcf	500 psf	30 °

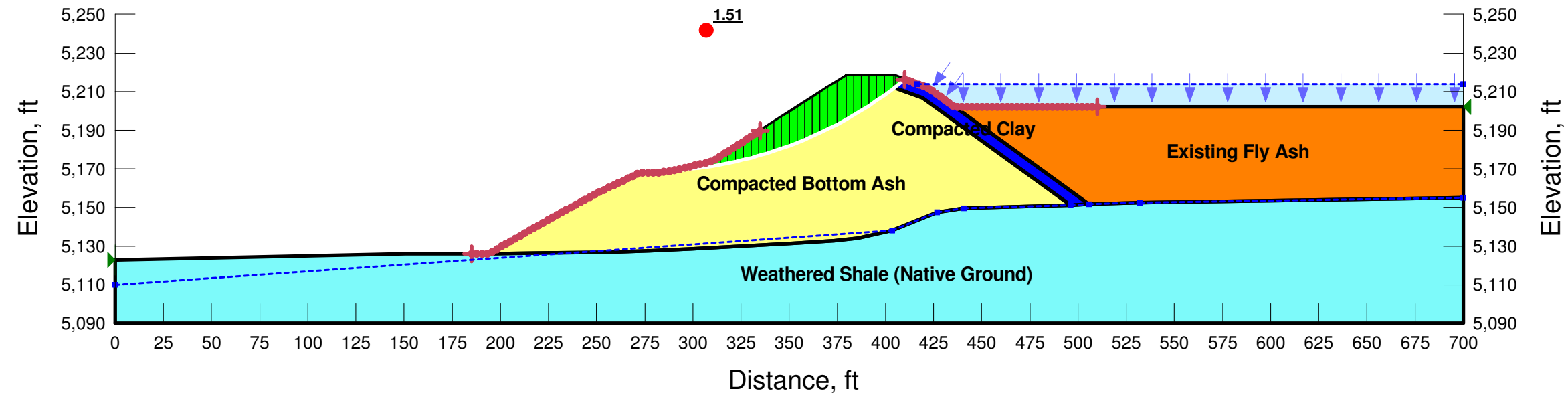

**Slope Stability Analysis
West Embankment
Lined Decant Water Pond**

**Four Corners Power Plant
Fruitland, New Mexico
Arizona Public Service**

**3) LDWP West Embankment - Seismic Loading
File Name: West Embankment - Steepest Upper Slope.gsz
Date: 6/3/2016
Method: Spencer**

Factor of Safety: 1.24

Note:
The results of the analysis shown here are based on available subsurface information, laboratory test results, and approximate soil properties. No warranties can be made regarding the continuity of subsurface conditions between the borings.

Material Type:	Unit Weight:	Cohesion:	Friction Angle:
Compacted Clay	125 pcf	300 psf	20 °
Compacted Bottom Ash	65 pcf	0 psf	34 °
Existing Fly Ash	90 pcf	0 psf	28 °
Weathered Shale (Native Ground)	120 pcf	500 psf	30 °

Horz Seismic Coef.: 0.083

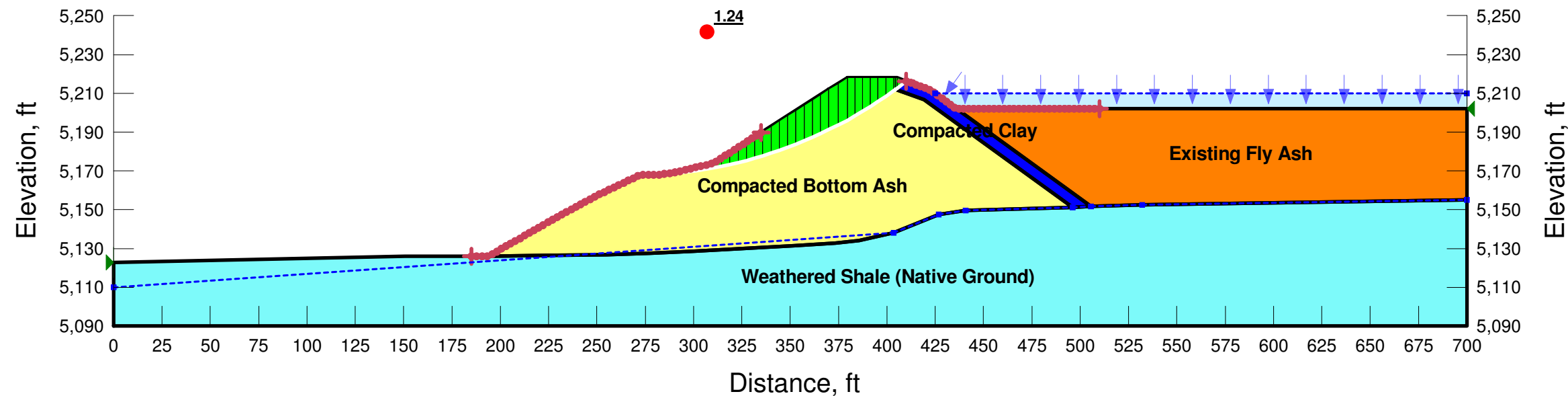

**Slope Stability Analysis
West Embankment
Lined Decant Water Pond**

**Four Corners Power Plant
Fruitland, New Mexico
Arizona Public Service**

**4) LDWP West Embankment - Long-Term, Maximum Storage Pool
File Name: West Embankment - Steepest Overall Slope.gsz
Date: 6/3/2016
Method: Spencer**

Factor of Safety: 1.58

Note:
The results of the analysis shown here are based on available subsurface information, laboratory test results, and approximate soil properties. No warranties can be made regarding the continuity of subsurface conditions between the borings.

Material Type:	Unit Weight:	Cohesion:	Friction Angle:
Compacted Clay	125 pcf	300 psf	20 °
Compacted Bottom Ash	65 pcf	0 psf	34 °
Existing Fly Ash	90 pcf	0 psf	28 °
Weathered Shale (Native Ground)	120 pcf	500 psf	30 °

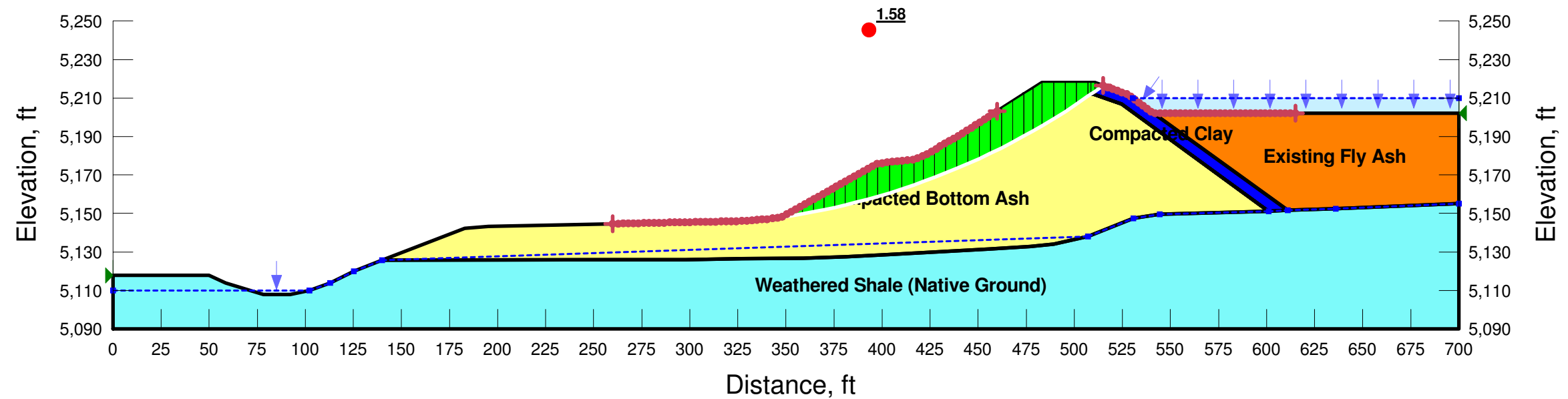

**Slope Stability Analysis
West Embankment
Lined Decant Water Pond**

**Four Corners Power Plant
Fruitland, New Mexico
Arizona Public Service**

**5) LDWP West Embankment - Maximum Surcharge Pool
File Name: West Embankment - Steepest Overall Slope.gsz
Date: 6/3/2016
Method: Spencer**

Factor of Safety: 1.58

Note:
The results of the analysis shown here are based on available subsurface information, laboratory test results, and approximate soil properties. No warranties can be made regarding the continuity of subsurface conditions between the borings.

Material Type:	Unit Weight:	Cohesion:	Friction Angle:
Compacted Clay	125 pcf	300 psf	20 °
Compacted Bottom Ash	65 pcf	0 psf	34 °
Existing Fly Ash	90 pcf	0 psf	28 °
Weathered Shale (Native Ground)	120 pcf	500 psf	30 °

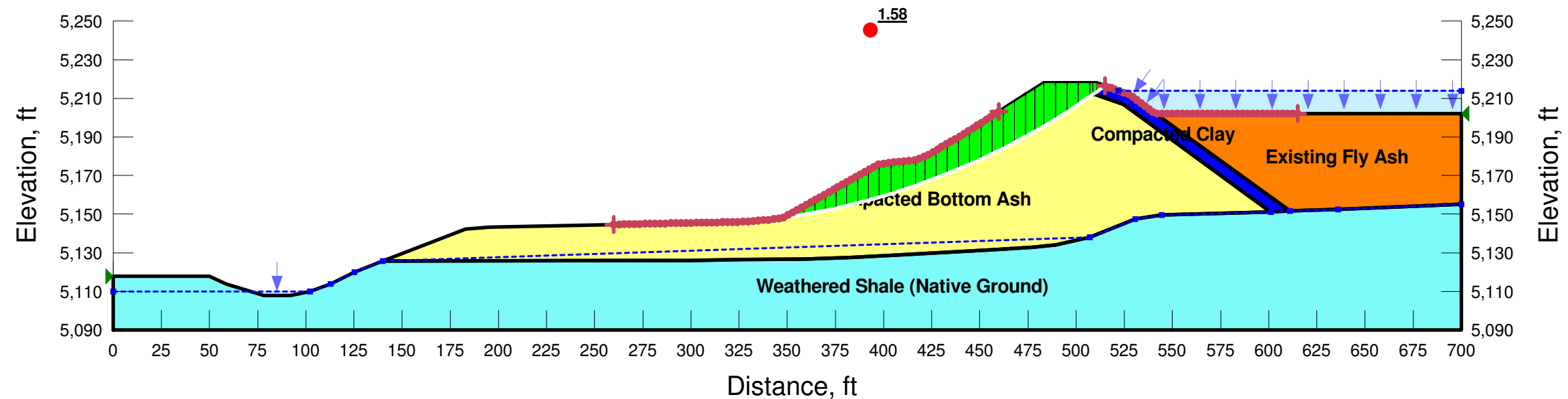

**Slope Stability Analysis
West Embankment
Lined Decant Water Pond**

**Four Corners Power Plant
Fruitland, New Mexico
Arizona Public Service**

**6) LDWP West Embankment - Seismic Loading
File Name: West Embankment - Steepest Overall Slope.gsz
Date: 6/3/2016
Method: Spencer**

Factor of Safety: 1.29

Note:
The results of the analysis shown here are based on available subsurface information, laboratory test results, and approximate soil properties. No warranties can be made regarding the continuity of subsurface conditions between the borings.

Material Type:	Unit Weight:	Cohesion:	Friction Angle:
Compacted Clay	125 pcf	300 psf	20 °
Compacted Bottom Ash	65 pcf	0 psf	34 °
Existing Fly Ash	90 pcf	0 psf	28 °
Weathered Shale (Native Ground)	120 pcf	500 psf	30 °

Horz Seismic Coef.: 0.083

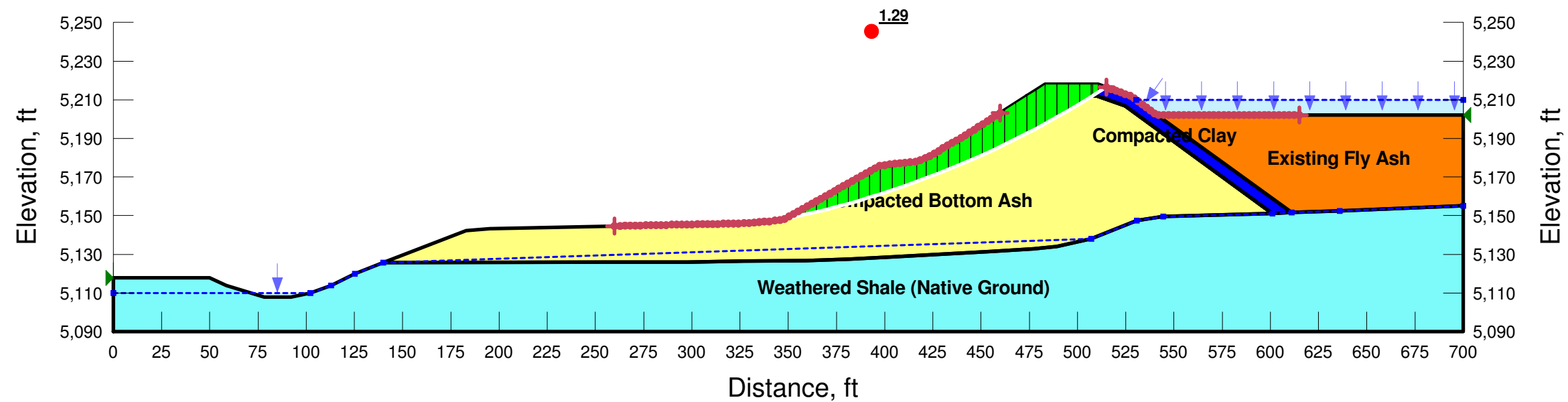

**Slope Stability Analysis
South Embankment
Lined Decant Water Pond**

**Four Corners Power Plant
Fruitland, New Mexico
Arizona Public Service**

7) LDWP South Embankment - Long-Term, Maximum Storage Pool

File Name: South Embankment.gsz

Date: 4/14/2016

Method: Spencer

Factor of Safety: 1.58

Note:
The results of the analysis shown here are based on available subsurface information, laboratory test results, and approximate soil properties. No warranties can be made regarding the continuity of subsurface conditions between the borings.

Material Type:	Unit Weight:	Cohesion:	Friction Angle:
Compacted Clay	125 pcf	300 psf	20 °
Compacted Bottom Ash	65 pcf	0 psf	34 °
Existing Fly Ash	90 pcf	0 psf	28 °
Weathered Shale (Native Ground)	120 pcf	500 psf	30 °

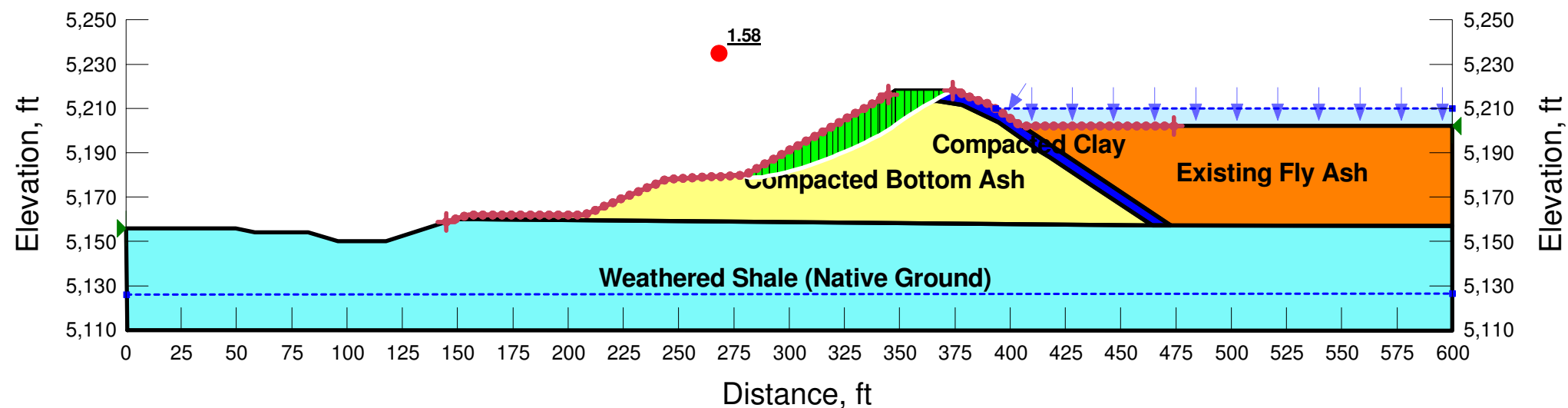

**Slope Stability Analysis
South Embankment
Lined Decant Water Pond**

**Four Corners Power Plant
Fruitland, New Mexico
Arizona Public Service**

8) LDWP South Embankment - Maximum Surcharge Pool

File Name: South Embankment.gsz

Date: 4/14/2016

Method: Spencer

Factor of Safety: 1.58

Note:
The results of the analysis shown here are based on available subsurface information, laboratory test results, and approximate soil properties. No warranties can be made regarding the continuity of subsurface conditions between the borings.

Material Type:	Unit Weight:	Cohesion:	Friction Angle:
Compacted Clay	125 pcf	300 psf	20 °
Compacted Bottom Ash	65 pcf	0 psf	34 °
Existing Fly Ash	90 pcf	0 psf	28 °
Weathered Shale (Native Ground)	120 pcf	500 psf	30 °

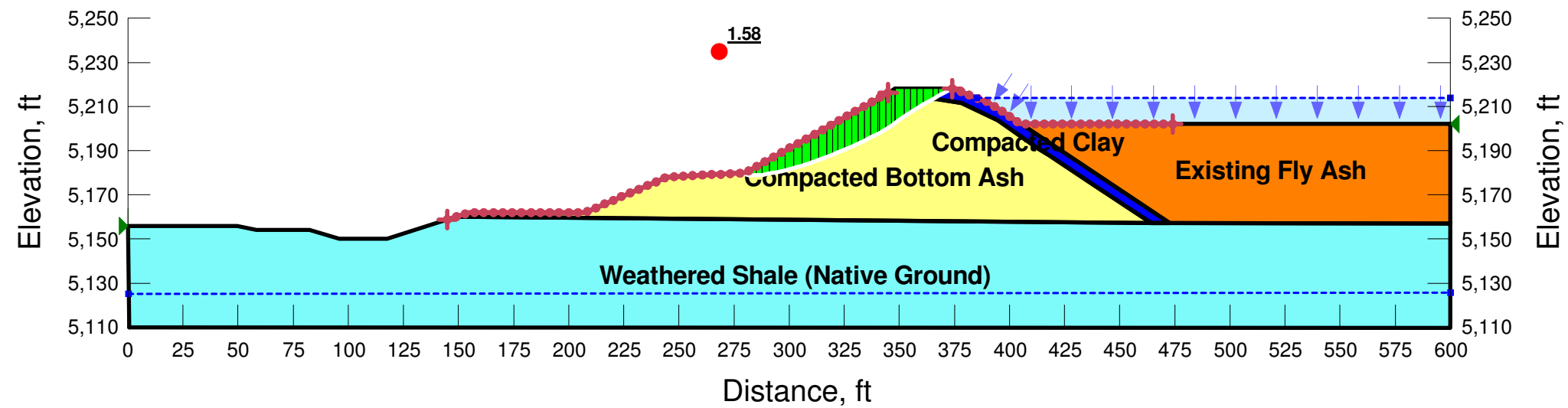

**Slope Stability Analysis
South Embankment
Lined Decant Water Pond**

**Four Corners Power Plant
Fruitland, New Mexico
Arizona Public Service**

9) LDWP South Embankment - Seismic Loading

File Name: South Embankment.gsz

Date: 4/14/2016

Method: Spencer

Factor of Safety: 1.31

Note:
The results of the analysis shown here are based on available subsurface information, laboratory test results, and approximate soil properties. No warranties can be made regarding the continuity of subsurface conditions between the borings.

Material Type:	Unit Weight:	Cohesion:	Friction Angle:
Compacted Clay	125 pcf	300 psf	20 °
Compacted Bottom Ash	65 pcf	0 psf	34 °
Existing Fly Ash	90 pcf	0 psf	28 °
Weathered Shale (Native Ground)	120 pcf	500 psf	30 °

Horz Seismic Coef.: 0.083

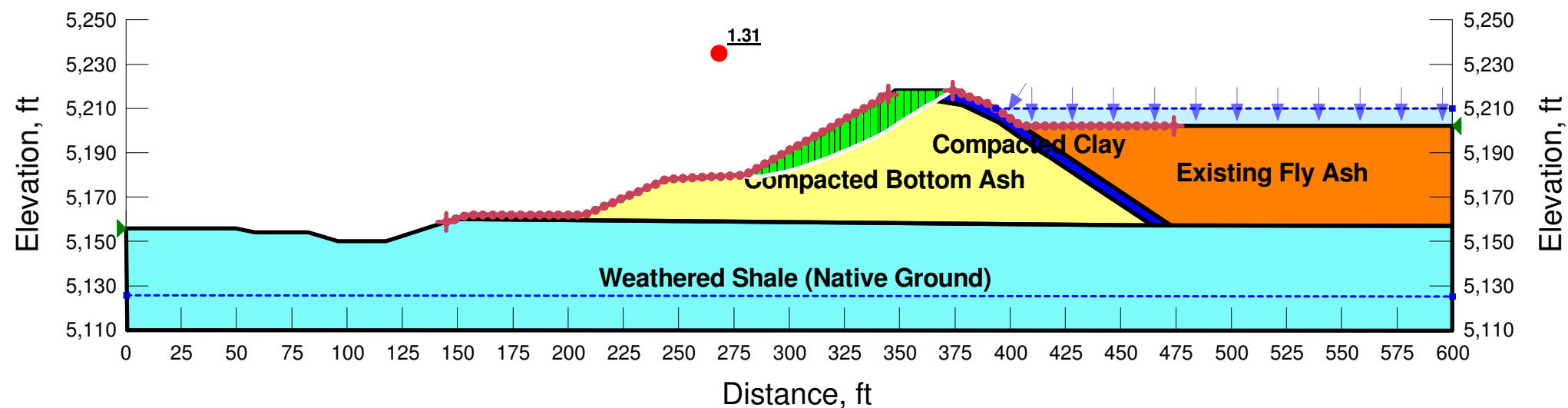

aecom.com