

FOUR CORNERS POWER PLANT LINED ASH IMPOUNDMENT

Periodic Inflow Design Flood Control System Plan

October 2021
AECOM Project 60664563

Prepared for:

Arizona Public Service
400 North 5th Street
Phoenix, AZ 85004

Prepared by:

AECOM
7720 North 16th Street, Suite 100
Phoenix, AZ 85020
aecom.com

Table of Contents

1. Introduction	1
2. Methodology	1
3. Applicability of 2016 Plan Hydrologic Design Basis	2
4. 2016 Plan – Review by Section	3
4.1 “§257.82 Hydrologic and Hydraulic capacity requirements for CCR surface impoundments”	3
4.2 “Overview”	3
4.3 “§257.82 (a)(1)(2)(3) Hydrologic and Hydraulic capacity requirements for CCR surface impoundments”	4
4.4 “§257.82 (b) Hydrologic and Hydraulic capacity requirements for CCR surface impoundments”	4
4.5 “§257.82 (c)(1)(2)(3)(4)(5) Hydrologic and Hydraulic capacity requirements for CCR surface impoundments”	4
4.6 “§257.82 (d) Hydrologic and Hydraulic capacity requirements for CCR surface impoundments”	4
5. Recommended Additional Technical Investigations or Evaluations	5
6. Conclusion	5
7. Limitations	5
8. Certification Statement	6

Attachment

Attachment A: AECOM, 2021, *Calculation - IDF Storage Capacity of APS FC Lined Ash Impoundment (LAI)*, October 8, 2021,

Attachment B: AECOM, 2016, *Four Corners Power Plant, Lined Ash Impoundment, Inflow Design Flood Control System Plan, FC_InflowFlood_008_20161017*, August 31, 2016.

1. Introduction

This Periodic Inflow Design Flood Control System Plan for the Lined Ash Impoundment at Four Corners Power Plant, operated by Arizona Public Service (APS), has been prepared in accordance with the requirements of Title 40 of the Code of Federal Regulations Part 257 (40 CFR 257) (“the Coal Combustion Residuals [CCR] Rule”, or “the Rule”) and the specific requirement of 40 CFR § 257.82(c)(4) that “(t)he owner or operator of the CCR unit must prepare periodic inflow design flood control system plans required by paragraph (c)(1) of this section every five years.”

2. Methodology

The methodology used to prepare this 2021 Periodic Inflow Design Flood Control System Plan for the Lined Ash Impoundment (LAI) at the Four Corners Power Plant is for the certifying Qualified Professional Engineer (QPE) to:

Identify and review the hydrologic design basis references used for the 2016 Plan and verify applicability for use in 2021.

- a. Perform a documented review of each major component of the contributing technical information from:
 - i. AECOM, 2016, Four Corners Power Plant, Lined Ash Impoundment, Inflow Design Flood Control System Plan, FC_InflowFlood_008_20161017, August 31, 2016, (hereafter referred to as the “2016 Plan” and incorporated and referenced directly as Attachment B to this document).
- b. Consider and document whether the 2016 Plan and its conclusions:
 - i. Meet the current reporting requirements of the Rule;
 - ii. Reflect the current condition of the structure, as known to the QPE and documented in the annual inspections;
 - iii. Are compromised by any identified issues of concern; and
 - iv. Are consistent with the standard of care of professionals performing similar evaluations in this region of the country; and
- c. Identify any additional analyses, investigations, inspections, and/or repairs that should be completed in order to complete this 2021 Recertification.

This plan documents the results of these considerations, incorporates the 2016 Plan as an Appendix, identifies any additional technical investigation or evaluations (if needed), and presents an updated certification by the QPE.

3. Applicability of 2016 Plan Hydrologic Design Basis

In 2016, the LAI was an active pond, receiving a gravity inflow of sluiced FGD solid. Between 2016 and cessation of deposition April 2021, the pond received and was significantly filled by FGD solids.

In 2016, and in 2021, studies have assigned the Significant Hazard Potential classification to the LAI. 40 CFR §257.82(a)(3)(ii) requires that, for a Significant Hazard Potential CCR surface impoundment, the Inflow Design Flood (IDF) is the 1,000-year flood.

In 2016, APS elected to demonstrate capacity to store and/or pass the IDF by presenting similar, earlier calculations of a 72-hour PMP flood storage/routing through the LAI to the Lined Decant Water Pond (LDWP). The LAI and LDWP are both formed by perimeter embankments and therefore receive runoff only from direct precipitation, although the LAI may drain to the LDWP by the gravity decant tower. The 2016 hydrologic design basis requires that the LAI be able to store the IDF on the LAI and the LDWP be able to store the IDF on the LDWP and drained from the LAI, in the case that the LAI does drain during the storm to the LDWP.

The 72-hour PMP was estimated to have a precipitation depth of 10.9 inches, which is significantly greater than the precipitation estimate for the 1000-year flood event (“less than 4 inches”). The 2016 hydrologic design basis demonstrated that the more extreme flood, the 72-hour PMP runoff, could be stored/routed successfully in the LAI and concluded, therefore, that the this aspect of the LAI complies with the less-stringent requirement of the CCR Rule for the LAI to store/route the smaller 1,000-year flood.

In 2021, for this Periodic Inflow Design Flood Control System Plan, APS has elected to provide a new calculation to demonstrate capacity of the LAI to store the 1,000-year flood IDF for a Significant Hazard Potential CCR surface impoundment. This calculation, “AECOM, 2021, *Calculation - IDF Storage Capacity of APS FC Lined Ash Impoundment (LAI)*, October 8, 2021” is included in the 2021 Plan as Attachment A.

The 2021 calculation, presented as Attachment A, concludes the following:

- a. The 1,000-year flood with the highest precipitation depth (3.92 inches) is the “72-hour tropical storm”;
- b. The anticipated runoff volume to the LAI for the 1,000-year, 72-hour tropical storm event is 44.4 acre-feet;
- c. The current minimum crest elevation of the West Embankment is 5279.0 feet (NGVD29), based on 2021 topographic survey;
- d. The NMOSE-required 2.8 feet of residual freeboard (for wave run-up, etc.) requires the maximum flood pool elevation be 2.8 feet lower than the minimum crest, i.e. 5276.2 feet (NGVD29);
- e. The 44.4 acre-feet runoff from the IDF can be stored between elevations 5276.2 feet and 5274.1 feet (NGVD29); and, therefore,
- f. the maximum normal operating level in the LAI must be maintained at or below Elevation 5274.1 feet (NGVD29).

In future years, APS may elect to place additional fill on the crest to restore the West Embankment minimum crest elevation to 5280.0 feet (NGVD29). However, AECOM concludes that, for the current configuration of the LAI impoundment, the IDF runoff of 44.4 acre-feet can be stored with adequate residual freeboard with a Plant operational requirement to maintain the normal operating pool at or below Elevation 5274.1 feet (NGVD29).

Therefore, this section of the 2016 Plan, as amended by this analysis and the calculation in Attachment A, adequately represents current conditions and satisfies the requirements of the Rule.

4. 2016 Plan – Review by Section

Other than as described in the remainder of this section, the details presented in this section of the 2016 Plan adequately represent current conditions and satisfy the requirements of the Rule.

4.1 “\$257.82 Hydrologic and Hydraulic capacity requirements for CCR surface impoundments”

The details presented in this section of the 2016 Plan accurately describe the requirements of the Rule.

4.2 “Overview”

In April 2021, APS ceased discharges, including slurried FGD solids, to the LAI. FGD slurry is now blended with dry fly ash within the Plant and disposed as a blended solid in the Dry Fly Ash Disposal Area (DFADA) facility. Other flows previously reporting to the LAI now report to the Return Water Pond (RWP). APS intends to close the LAI by “closure in place”, with an evapotranspiration soil cover within the time frames allowed by the Rule for a surface impoundment of this size.

The design basis and calculation (attachment A) described in Section 3 “Applicability of 2016 Plan Hydrologic Design Basis” of this 2021 Plan are intended to supersede the following statements in this section of the 2016 Plan:

“The LAI provides sufficient storage volume to accommodate the Probable Maximum Precipitation (PMP) runoff volume of 123 acre-feet. This PMP event is based on a precipitation depth of 10.9 inches and exceeds the runoff volume associated with a 1,000 year flood event which would be based on a rainfall depth of less than 4 inches.”

With the new information introduced in Section 3, the new calculation in Attachment A, and the clarification of the superseded information, the details presented in this section of the 2016 Plan adequately represent current conditions and satisfy the requirements of the Rule.

4.3 “§257.82 (a)(1)(2)(3) Hydrologic and Hydraulic capacity requirements for CCR surface impoundments”

A separate 2021 Periodic Hazard Potential Study confirms the assignment of the Significant Hazard Potential classification to the LAI. Therefore, this aspect of the 2016 Plan adequately represents current conditions and satisfies the requirements of the Rule.

Operational aspects described in the 2016 Plan have changed significantly due to the cessation of discharge of sluiced FGD to the LAI in 2021. These changes are described in Section 4.2 “Overview”.

The information presented in the right column of the 2016 Plan in the third of three paragraphs in answer to 40 CFR §257.82 (a)(1) is now superseded by the new information introduced in Section 3 and the new calculation in Attachment A of this 2021 Plan.

The information presented in the right column of the 2016 Plan in answer to 40 CFR §257.82 (a)(2) is accurate and current, with the following exception:

- a. The LAI does not in 2021 have sufficient capacity to retain the 72-hour PMP with 2.8 feet of residual freeboard, although it does have equivalent capacity to retain the 1,000-year, 72-hour IDF.

The information presented in the right column of the 2016 Plan in answer to 40 CFR §257.82 (a)(3) is accurate and current.

Therefore, this section of the 2016 Plan, as amended by this analysis, adequately represents current conditions and satisfies the requirements of the Rule.

4.4 “§257.82 (b) Hydrologic and Hydraulic capacity requirements for CCR surface impoundments”

The details presented in this section of the 2016 Plan adequately represent current conditions and satisfy the requirements of the Rule.

4.5 “§257.82 (c)(1)(2)(3)(4)(5) Hydrologic and Hydraulic capacity requirements for CCR surface impoundments”

The owner or operator continues to acknowledge and will comply with these requirements.

Per the requirement of §257.82 (c)(4), this document constitutes the “every five years” Periodic Inflow Design Flood Control System Plan.

A certification of this Periodic Inflow Design Flood Control System Plan by a QPE is included in this document per the requirement of §257.82(c)(5).

4.6 “§257.82 (d) Hydrologic and Hydraulic capacity requirements for CCR surface impoundments”

The owner or operator continues to acknowledge and will comply with these requirements.

5. Recommended Additional Technical Investigations or Evaluations

None identified and none recommended.

6. Conclusion

The 2016 Plan and its conclusions, as amended by the analyses presented in this 5-Year periodic revision, meet the current reporting requirements of the Rule, reflect the current condition of the structure as known to the QPE and documented in the annual inspections, are not compromised by any identified issues of concern, and are consistent with the standard of care of professionals performing similar evaluations in this region of the country.

7. Limitations

This document is for the sole use of APS on this project only and is not to be used for other projects. In the event that conclusions based upon the data presented in this document are made by others, such conclusions are the responsibility of others.

The Periodic Inflow Design Flood Control System Plan presented in this report is based on the 2016 Plan and relies and incorporates any Limitations expressed in that document.

The Certification of Professional Opinion in this report is limited to the information available to AECOM at the time this Assessment was performed in accordance with current practice and the standard of care. Standard of care is defined as the ordinary diligence exercised by fellow practitioners in this area performing the same services under similar circumstances during the same period. Professional judgments presented herein are primarily based on information from previous reports that have been assumed to be accurate, knowledge of the site, and partly on our general experience with dam safety evaluations performed on other dams.

No warranty or guarantee, either written or implied, is applicable to this work. The use of the word “certification” and/or “certify” in this document shall be interpreted and construed as a Statement of Professional Opinion and is not and shall not be interpreted or construed as a guarantee, warranty, or legal opinion.

8. Certification Statement

Certification Statement for:

- Certification Statement 40 CFR § 257.82(c)(5) – Periodic Inflow Design Flood Control System Plan for an Existing CCR Surface Impoundment.
- CCR Unit: Arizona Public Service; Four Corners Power Plant; Lined Ash Impoundment

I, Alexander W. Gourlay, being a Registered Professional Engineer in good standing in the State of New Mexico, do hereby certify, to the best of my knowledge, information, and belief, that the information contained in this certification has been prepared in accordance with the accepted practice of engineering. I certify, for the above-referenced CCR Unit, that the information contained in this Periodic Inflow Design Flood Control System Plan dated October 2021, including the technical content in Attachments A and B, meets the requirements of 40 CFR § 257.81.

Alexander W. Gourlay, P.E.
Printed Name

October 11, 2021
Date

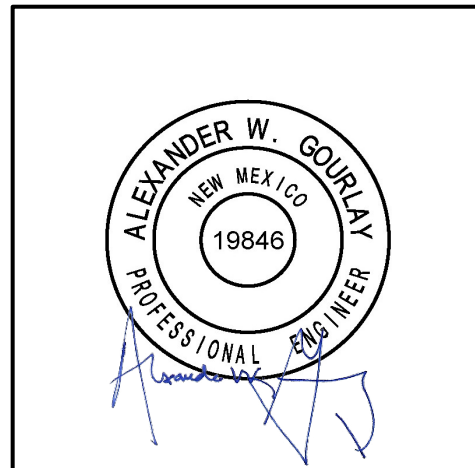

Attachment A:

AECOM, 2021, *Calculation - IDF Storage Capacity of APS FC Lined Ash Impoundment (LAI)*, October 8, 2021.

Attachment B:

AECOM, 2016, *Four Corners Power Plant, Lined Ash Impoundment, Inflow Design Flood Control System Plan, FC_InflowFlood_008_20161017*, August 31, 2016.



ATTACHMENT A
AECOM, 2021, *Calculation - IDF Storage Capacity of APS FC Lined*
Ash Impoundment (LAI),
October 8, 2021.

DCS

Calculation Cover Page Template

Q2[DCS]-351-FM5

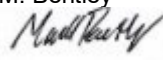
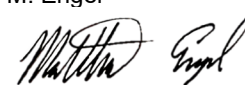
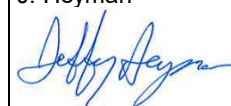
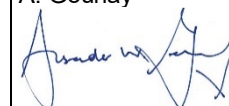
Project 5-Year CCR Periodic Recertifications – IDF Storage Capacity of APS FC Lined Ash Impoundment (LAI)	Job No. 60664563
Client Arizona Public Service, Four Corners Power Plant	Department/Discipline Hydrology and Civil
Software Name AutoCAD	

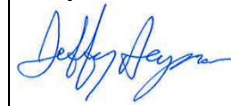
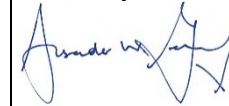
Calculation Rev. No.	Originator Self Check (name and signature)	Reviewer/Checker (name and signature)	Independent Peer Reviewer (if used/required) (name & signature)	Approver (name & signature)
2.0 Hydrology	M. Bentley 	M. Engel 	J. Heyman 	A. Gourlay 
3.0 Elevation-Capacity	M. Engel 	M. Bentley 	J. Heyman 	A. Gourlay 

Add rows as required

<p>Calculation Objective: Verify the LAI has capacity to store or pass 1000-year flood, as a significant hazard potential CCR surface impoundment, per 40 CFR § 257.73(d)(1)(v)(2).</p>
<p>Calculation Methodology: Identify the runoff volume to the LAI from the worst-case 1000-year flood. Using 2021 topography for the impoundment, identify the maximum normal operating pool elevation that will allow storage of the 1000-year flood within the LAI (no discharge) while still providing the NMOSE-approved 2.8 feet of residual freeboard below the 2021-surveyed minimum crest elevation.</p>
<p>References / Inputs/ Field Data:</p> <ol style="list-style-type: none"> 1. New Mexico Office of the State Engineer Dam Safety Bureau, Initial and Interim Use of Regional Extreme Precipitation Study (REPS) Tools for Probable Maximum Precipitation and Annual Exceedance Probability Rainfall Estimation, 2019 2. Wilson & Company, Engineers & Architects, Inc Survey flown on 06/19/2021. NAD27/NAVD29. New Mexico State Plane, West Zone.
<p>Assumptions: (Include comments on need to revise calculations after more data is collected/confirmed and/or after assumptions have been verified.)</p> <p>Assumptions, if any, are presented within the body of the calculation.</p>
<p>Conclusions including confirmations to be obtained:</p> <p>If the maximum normal operating pool is maintained below elevation 5274.1 ft (NGVD29) (equivalent to 5277.1 ft, NAVD88), the maximum flood pool corresponding to the 1000-year tropical storm event will be 5276.2 ft (NGVD29), which leaves 2.8 feet freeboard below the 2021-surveyed minimum crest elevation 5279.0 feet (NGVD29).</p>

This calculation is complete and ready for Discipline Review:

N/A

See PDF signature blocks above

Originator Name

Signature

Date

AECOM Job: 60664563

Client: Arizona Public Service, Four Corners Power Plant

Project Name: APS Four Corners 5-Year Periodic CCR Recertifications

Calculation: Calculation - IDF Storage Capacity of APS FC Lined Ash Impoundment (LAI)

Rev./Date: 1, 10-8-2021

1.0 Background and Objective

Background:

The final raise of the Lined Ash Impoundment occurred in 2014 and raised the West Embankment to nominal crest elevation 5280.0 Feet (NGVD29). The 2016 IDF Routing and Structural Integrity Assessment Reports, prepared and published to comply with the requirements of 40 CFR § 257.73, each presented hydrology and elevation-capacity information to demonstrate that the LAI, which does not have a traditional spillway, and has a complete perimeter containment embankment so that it cannot receive run-on from a precipitation event, could store direct precipitation from the PMP entirely within the containment embankments, while maintaining a 2.8 feet freeboard in accordance with the NMOSE operating License No. D-634.

Because the LAI dam does not meet the criteria for classification as either Low Hazard Potential or High Hazard Potential, it was classified as a Significant Hazard Potential CCR surface impoundment in the 2016 Structural Integrity Report. 40 CFR § 257.73(d)(1)(v)(2) requires that “(t)he combined capacity of all spillways must adequately manage flow during and following the peak discharge from a ... 1000-year flood for a significant hazard potential CCR surface impoundment”.

For purpose of required periodic recertification of the spillway capacity of the LAI, this calculation will demonstrate that the surface impoundment can store, without discharge, the 1000-year flood while maintaining the 2.8-foot freeboard required by NMOSE operating License No. D-634.

Since the completion and posting of the 2016 Reports, the solids discharge to the impoundment continued until April 2021. An aerial survey of the impoundment by Wilson & Company (2021) indicates a lowering of the West Embankment crest from its nominal as-built elevation of 5280.0 ft (NGVD29) elevation by 0.75 to 1.0 feet. Possible causes include the cumulative impact of periodic regrading of the crest road and consolidation of the older ash deposits on which the impoundment was constructed. This calculation reflects the current minimum crest elevation of 5279.0 ft (NGVD29).

Calculation Objective:

Verify the LAI has capacity to store 1000-year flood, as a significant hazard potential CCR surface impoundment, per 40 CFR § 257.73(d)(1)(v)(2)

Methodology:

Identify the runoff volume to the LAI from the 1000-year flood. Using 2021 topography for the impoundment, identify the maximum normal operating level elevation that will allow storage of the 1000-year flood within the LAI (no discharge) while still providing the NMOSE-approved 2.8 feet freeboard below the 2021-surveyed minimum crest elevation.

2.0 Hydrology

Precipitation estimates for the LAI were obtained using the Colorado-New Mexico Regional Extreme Precipitation Study (REPS) and the METPortal Precipitation Frequency (PF) Tools. The REPS tool calculates inter-durational Probable Maximum Precipitation (PMP) depth for Local Storms, General Storms, and Tropical Storms using an ESRI polygon shapefile representing the tributary drainage area. The MetPortal PF tool calculates watershed precipitation frequency estimates up to the 10⁻⁷ Annual Exceedance Probability (AEP). The tributary area to the LAI, which is the pond area itself because no run-on can occur, and precipitation estimates obtained from the tools are provided in Figure 1 and Table 1 respectively.



Figure 1. Tributary area to LAI (Red)

Table 1. Precipitation Estimates

Storm Type	Storm Duration	PMP Depth (REPS Tool)	1,000-Year (MetPortal)
(---)	(hrs)	(in)	(in)
Local	24	7.40	*< Tropical N/A
Tropical	72	9.40	3.92
General	72	7.50	*< Tropical N/A

**Tropical Storm yields highest volume therefore it was only storm carried forward in analysis*

Runoff estimates were obtained using the Natural Resource Conservation Service (NRCS) Synthetic Unit Hydrograph (SCS) Method. A curve number of 100 was used to account for rainfall losses based on the conservative assumption the impoundment would be slightly inundated at the start of the storm. Since the pond is intended to fully retain the design storm volume only, volume peak flowrates are not a consideration and only volume calculations were performed. The anticipated runoff volume to the LAI for the 1,000-year 72-Hour event is the **44.4 Acre-Feet**, which, conservatively, is assumed to all run-off and pond in the lower, southwest corner of the pond. Calculations associated with the volume estimate are included in Table 2.

Table 2. NRCS SCS Method Volume Estimate for 72-Hour, 1,000-year storm event.

Subbasin	Area	Runoff Volume	Runoff	Precipitation Depth	Storage	Curve Number	Initial Abstraction
(---)	(acres)	(ac-ft)	(in)	(in)	(in)	(---)	(in)
LAI	135.9	44.4	3.92	3.92	0.00	100	0.00

3.0 Elevation-Capacity

The following inputs and criteria were used as a basis for estimating volumes and corresponding maximum operating level elevation in the LAI:

- All elevation references are to the NGVD29 datum unless identified otherwise.
- LAI crest low point elevation of 5279.0 based on reviewing the survey data.
- 2.8 feet of residual freeboard from crest low point to maximum flood pool elevation as required by the NMOSE operating license.
- Runoff volume of 44.4 ac-ft (as presented in Section 2.0) for the 1,000-yr 72-Hour storm event.
- The maximum normal operating level is defined by the maximum pond elevation that allows for storage of the 1000-yr flood with 2.8 feet of residual freeboard below the minimum crest elevation.

The storage-capacity curve presented below was developed using AutoCAD Civil 3D software and the topographic survey provided by Wilson & Co. The maximum normal operating level that allows for storage of the 1000-yr flood and 2.8 feet of residual freeboard is **El 5274.1 (NGVD 29)**. The graph identifies the key elevation and storage volumes associated with this storm event. The elevation-storage information is also provided in Table 3..

Figure 2: LAI ELEVATION-CAPACITY CURVE

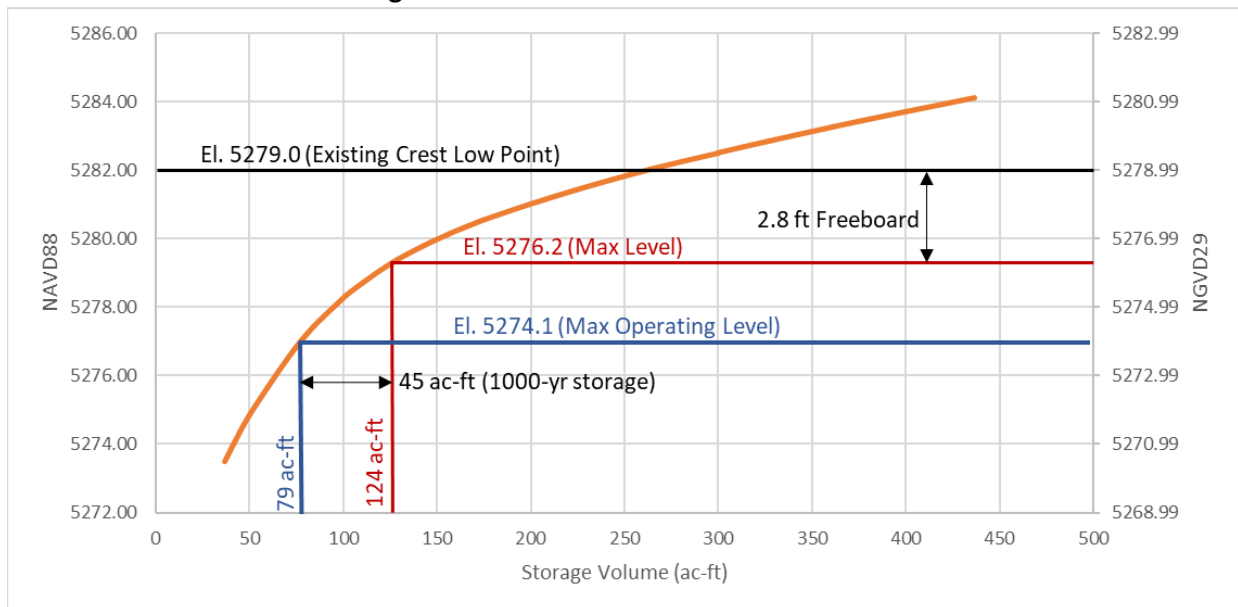

Table 3: Elevation – Capacity Summary Table

Description	Elevation (NGVD29)	Cumulative Storage Volume (ac-ft)
LAI Dam Crest Low Point	5279.0	263
Maximum Flood Pool Level (Bottom of Freeboard)	5276.2	124
Maximum Normal Operating Level	5274.1	79

4.0 Conclusion

If the maximum normal operating level is maintained below elevation 5274.1 feet (NGVD29) (equivalent to 5277.1 feet, NAVD88), the maximum flood pool corresponding to the 1000-year flood will be 5276.2 feet (NGVD29), which allows for the permitted 2.8 feet of residual freeboard below to 2021-surveyed minimum crest elevation of 5279.0 feet (NGVD29).

ATTACHMENT B
AECOM, 2016, *Four Corners Power Plant, Lined Ash Impoundment,*
Inflow Design Flood Control System Plan,
FC_InflowFlood_008_20161017, August 31, 2016.

**FOUR CORNERS POWER PLANT
LINED ASH IMPOUNDMENT
INFLOW DESIGN FLOOD CONTROL SYSTEM PLAN
FC_InflowFlood_008_20161017**

This *Inflow Design Flood Control System Plan* (Plan) document has been prepared specifically for the Lined Ash Impoundment (LAI) at the Four Corners Power Plant. This Plan has been prepared in accordance with our understanding of the requirements prescribed in §257.82 of the Federal Register, Volume 80, Number 74, dated April 17, 2015 (U. S. Government, 2015) for hydrologic and hydraulic capacity requirements for CCR surface impoundments associated with existing Coal Combustion Residual (CCR) surface impoundments. Section §257.82 is reproduced below for reference purposes. This document serves as the *initial plan* described in §257.82.

The LAI is an existing CCR surface impoundment facility that has been expanded in several stages. Calculations prepared previously in support of the facility operation have been referenced and reproduced herein to address the requirements listed.

§257.82 Hydrologic and Hydraulic capacity requirements for CCR surface impoundments

(a) The owner or operator of an existing or new CCR surface impoundment or any lateral expansion of a CCR surface impoundment must design, construct, operate, and maintain an inflow design flood control system as specified in paragraphs (a)(1) and (2) of this section.

(1) The inflow design flood control system must adequately manage flow into the CCR unit during and following the peak discharge of the inflow design flood specified in paragraph (a)(3) of this section.

(2) The inflow design flood control system must adequately manage flow from the CCR unit to collect and control the peak discharge resulting from the inflow design flood specified in paragraph (a)(3) of this section.

(3) The inflow design flood is:

(i) For a high hazard potential CCR surface impoundment, as determined under §257.73(a)(2) or §257.74(a)(2), the probable maximum flood;

(ii) For a significant hazard potential CCR surface impoundment, as determined under §257.73(a)(2) or §257.74(a)(2), the 1,000-year flood;

(iii) For a low hazard potential CCR surface impoundment, as determined under §257.73(a)(2) or §257.74(a)(2), the 100-year flood; or

(iv) For an incised CCR surface impoundment, the 25-year flood.

(b) Discharge from the CCR unit must be handled in accordance with the surface water requirements under §257.3-3.

(c) *Inflow design flood control system plan* –

(1) *Content of the Plan*. The owner or operator must prepare initial and periodic inflow design flood control system plans for the CCR unit according to the timeframes specified in paragraphs (c)(3) and (4) of this section. These plans must document how the inflow design flood control system has been

designed and constructed to meet the requirements of this section. Each plan must be supported by appropriate engineering calculations. The owner or operator of the CCR unit has completed the inflow design flood control system plan when the plan has been placed in the facility's operating record as required by §257.105(g)(4).

(2) *Amendment of the Plan.* The owner or operator of the CCR unit may amend the written inflow design flood control system plan at any time provided the revised plan is placed in the facility's operating record as required by §257.105(g)(4). The owner or operator must amend the written inflow design flood control system plan whenever there is a change in conditions that would substantially affect the written plan in effect.

(3) *Timeframes for preparing the initial plan -*

(i) *Existing CCR surface impoundments.* The owner or operator must prepare the initial inflow design flood control system plan no later than October 17, 2016.

(ii) *New CCR surface impoundments and any lateral expansion of a CCR surface impoundment.* The owner or operator must prepare the initial inflow design flood control system plan no later than the date of initial receipt of CCR in the CCR unit.

(4) *Frequency for revising the plan.* The owner or operator must prepare periodic inflow design flood control system plans required by paragraph (c)(1) of this section every five years. The date of completing the initial plan is the basis for establishing the deadline to complete the first periodic plan. The owner or operator may complete any required plan prior to the required deadline provided the owner or operator places the completed plan into the facility's operating record within a reasonable amount of time. In all cases, the deadline for completing a subsequent plan is based on the date of completing the previous plan. For purposes of this paragraph (c)(4), the owner or operator has completed an inflow design flood control system plan when the plan has been placed in the facility's operating record as required by §257.105(g)(4).

(5) The owner or operator must obtain a certification from a qualified engineer stating that the initial and periodic inflow design flood control system plans meet the requirements of this section.

(d) The owner or operator of the CCR unit must comply with the record keeping requirements specified in §257.105(g), the notification requirements specified in §257.106(g), and the internet requirements specified in §257.107(g).

SITE INFORMATION	
Site Name / Address	Four Corners Power Plant / 691 CR-6100, Fruitland, NM 85416
Owner Name / Address	Arizona Public Service / 400 North 5 th Street, Phoenix, AZ 85004
CCR Unit	Lined Ash Impoundment (LAI)
<p>OVERVIEW</p> <p>The Lined Ash Impoundment (LAI) located at the Four Corners Power Plant (FCPP) is an existing jurisdictional dam structure/impoundment with a Significant Hazard classification. The contributing watershed to the LAI is limited to the surface area and direct precipitation associated with the impoundment. The LAI does not receive runoff from upstream tributary basins. The perimeter embankment of the LAI is raised above the natural ground surface on all sides, effectively precluding surface water run-on. The impoundment has been raised in a series of lifts with the most recent lift constructed to a minimum crest elevation of 5280 feet based on National Geodetic Vertical Datum 1929 (NGVD29).</p> <p>This Inflow Design Flood Control System Plan describes the contributing flow rates, runoff volumes, and storage capacities estimated previously as during the initial and expansion design s for the LAI embankment. The Significant Hazard dam classification associated with the LAI requires accommodation of the 1000-year runoff volume per §257.82 of the Federal Register. The LAI provides sufficient storage volume to accommodate the Probable Maximum Precipitation (PMP) runoff volume of 123 acre-feet. This PMP event is based on a precipitation depth of 10.9 inches and exceeds the runoff volume associated with a 1,000 year flood event which would be based on a rainfall depth of less than 4 inches.</p>	



Exhibit 1 – Lined Ash Impoundment (LAI) at Four Corners Power Plant Facility

§257.82 (a)(1)(2)(3) Hydrologic and Hydraulic capacity requirements for CCR surface impoundments

(a) The owner or operator of an existing or new CCR surface impoundment or any lateral expansion of a CCR surface impoundment must design, construct, operate, and maintain an inflow design flood control system as specified in paragraphs (a)(1) and (2) of this section.

(1) The inflow design flood control system must adequately manage flow into the CCR unit during and following the peak discharge of the inflow design flood specified in paragraph (a)(3) of this section.

The LAI does not receive runoff from upstream tributary basins and will only receive the inflow from direct precipitation onto the 135.9 acre LAI surface area.

The LAI has a significant hazard classification which requires accommodation of the 1,000-year flood event inflow runoff volume which is based on a precipitation depth of less than 4 inches. The runoff volume based on a Probable Maximum Precipitation (PMP) Event exceeds the runoff volume based on a 1,000 year flood event runoff volume since precipitation depths are 10.9 inches for the PMP flood event. The 72-hour PMP storm water runoff volume produced from the 135.9 acre LAI watershed is estimated to be 123 acre-feet as shown in **Figure 1** of the **Hydrology Analysis, Lined Ash Impoundment, Four Corners Power Plant**, prepared by URS Corporation in October 2011 (URS 2011), attached as Appendix 1.

The maximum operating water surface level is identified at elevation 5275.2 feet with storage volume for the PMP flood event provided above that. The LAI provides a storage volume above the maximum operating level of 401.33 acre-feet at to the embankment elevation of 5280 feet. The LAI accommodates the 123 acre-feet runoff volume in the impoundment above the maximum operating water surface elevation to elevation 5277.2 feet. A freeboard value of 2.8 feet is provided below the LAI embankment. The stage-storage relationship for the LAI is included as part of the **Hydrology Analysis, Lined Ash Impoundment, Four Corners Power Plant** (URS 2011). The LAI therefore meets the requirement to accommodate the 1,000 year inflow runoff volume.

<p>(a) The owner or operator of an existing or new CCR surface impoundment or any lateral expansion of a CCR surface impoundment must design, construct, operate, and maintain an inflow design flood control system as specified in paragraphs (a)(1) and (2) of this section.</p> <p>(2) The inflow design flood control system must adequately manage flow from the CCR unit to collect and control the peak discharge resulting from the inflow design flood specified in paragraph (a)(3) of this section.</p>	<p>The primary outlet spillway consists of a drop inlet tower located adjacent to the west side of the LAI. This drop inlet tower is a vertical, eight foot diameter, HDPE pipe with multiple drilled holes, to allow decant lateral inflow of water. The drop inlet drains into the Lined Decant Water Pond (LDWP) through a 16-inch HDPE pipe. The LAI has sufficient capacity to retain the 72-hour PMP runoff volume with 2.8 feet of residual freeboard, assuming that the drop inlet tower is clogged. The LDWP provides 517 acre-feet of storage volume, which accommodates the 72-hour PMP runoff volumes from the contributing watersheds to the LAI and LDWP of 123 and 50 acre-feet respectively (173 acre feet total). The stage-storage relationship for the LAI and LDWP is included as part of the Hydrology Analysis, Lined Ash Impoundment, Four Corners Power Plant (URS 2011).</p> <p>Refer to response to (a)(1) for additional details regarding the Inflow Design Flood Control System Plan for the LAI.</p>
<p>(a)(3) The inflow design flood is:</p> <p>(i) For a high hazard potential CCR surface impoundment, as determined under §257.73(a)(2) or §257.74(a)(2), the probable maximum flood;</p> <p>(ii) For a significant hazard potential CCR surface impoundment, as determined under §257.73(a)(2) or §257.74(a)(2) , the 1,000-year flood;</p> <p>(iii) For a low hazard potential CCR surface impoundment, as determined under §257.73(a)(2) or §257.74(a)(2), the 100-year flood; or</p> <p>(iv) For an incised CCR surface impoundment, the 25-year flood.</p>	<p>The hazard classification for the LAI is significant based on the Final Summary Report Structural Integrity Assessment, Lined Ash Impoundment, Four Corners Power Plant, prepared by AECOM in August 2016 (AECOM 2016).</p>

§257.82 (b) Hydrologic and Hydraulic capacity requirements for CCR surface impoundments	
(b) Discharge from the CCR unit must be handled in accordance with the surface water requirements under §257.3-3.	The discharge is handled in accordance with the surface water requirements under §257.3-3. Water in the LAI decants to the LDWP where it is pumped to the plant to be used as process water.
§257.82 (c)(1)(2)(3)(4)(5) Hydrologic and Hydraulic capacity requirements for CCR surface impoundments	
(c)(1) Content of the plan. The owner or operator must prepare initial and periodic inflow design flood control system plans for the CCR unit according to the timeframes specified in paragraphs (c)(3) and (4) of this section. These plans must document how the inflow design flood control system has been designed and constructed to meet the requirements of this section. Each plan must be supported by appropriate engineering calculations. The owner or operator of the CCR unit has completed the inflow design flood control system plan when the plan has been placed in the facility's operating record as required by §257.105(g)(4).	This <i>Inflow Design Flood Control Plan</i> serves as the initial plan prescribed herein.
(c)(2) <i>Amendment of the Plan.</i> The owner or operator of the CCR unit may amend the written inflow design flood control system plan at any time provided the revised plan is placed in the facility's operating record as required by §257.105(g)(4). The owner or operator must amend the written inflow design flood control system plan whenever there is a change in conditions that would substantially affect the written plan in effect.	The owner or operator acknowledges and will comply with this requirement.

<p>(c)(3) <i>Timeframes for preparing the initial plan</i> –</p> <p>(i) Existing CCR impoundments. The owner or operator must prepare the initial inflow design flood control system plan no later than October 17, 2016.</p> <p>(ii) New CCR surface impoundments and any lateral expansion of a CCR surface impoundment. The owner or operator must prepare the initial inflow design flood control system plan no later than the date of initial receipt of CCR in the CCR Unit</p>	<p>The LAI is an existing CCR impoundment at Four Corners Power Plant. The inflow design flood control system plan is included herein.</p> <p>The owner or operator acknowledges and will comply with this requirement.</p>
<p>(c)(4) <i>Frequency for revising the plan.</i> The owner or operator must prepare periodic inflow design flood control system plans required by paragraph (c)(1) of this section every five years. The date of completing the initial plan is the basis for establishing the deadline to complete the first periodic plan. The owner or operator may complete any required plan prior to the required deadline provided the owner or operator places the completed plan into the facility’s operating record within a reasonable amount of time. In all cases, the deadline for completing a subsequent plan is based on the date of completing the previous plan. For purposes of this paragraph (c)(4), the owner or operator has completed an inflow design flood control system plan when the plan has been placed in the facility’s operating record as required by §257.105(g)(4).</p>	<p>The owner or operator acknowledges and will comply with this requirement.</p>
<p>(c)(5) The owner or operator must obtain a certification from a qualified professional engineer stating that the initial and periodic inflow design flood control system plans meet the requirements of this section.</p>	<p>Certification by a professional engineer is included as an attachment to this document.</p>

§257.82 (d) Hydrologic and Hydraulic capacity requirements for CCR surface impoundments	
(d) The owner or operator of the CCR unit must comply with the recordkeeping requirements specified in §257.105(g), the notification requirements specified in §257.106(g), and the internet requirements specified in §257.107(g).	The owner or operator acknowledges and will comply with this requirement.

References

AECOM, August 2016, *Final Summary Report Structural Integrity Assessment, Lined Ash Impoundment, Four Corners Power Plant.*

URS Corporation, October 2011, *Hydrology Analysis, Lined Ash Impoundment 5280 Lift, Four Corners Power Plant.*

U.S. Government, April 2015, *Federal Register, Volume 80, Number 74, Rules and Regulations.*

Certification Statement 40 CFR § 257.82(c)(5) –Initial Inflow Design Flood Control System Plan for an Existing CCR Surface Impoundment

CCR Unit: Arizona Public Service; Four Corners Power Plant; Lined Ash Impoundment

I, Alexander W. Gourlay, being a Registered Professional Engineer in good standing in the State of New Mexico, do hereby certify, to the best of my knowledge, information, and belief, that the information contained in this certification has been prepared in accordance with the accepted practice of engineering. I certify, for the above-referenced CCR Unit, that the information contained in the initial inflow design flood control system plan dated August, 31, 2016 meets the requirements of 40 CFR § 257.82.

Alexander W. Gourlay, P.E.

Printed Name

August 31, 2016

Date

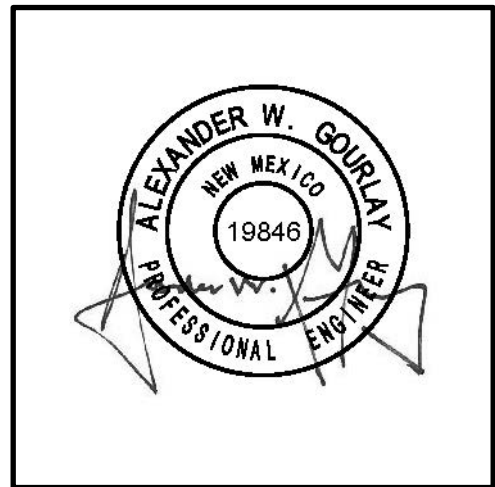

**APPENDIX 1 – HYDROLOGY ANALYSIS, LINED ASH IMPOUNDMENT 5280 LIFT,
FOUR CORNERS POWER PLANT**

Project Name:	Lined Ash Impoundment 5280 Raise	Project Number:	23446085
Project Location:	Four Corners Power Plant, NM	Client Name:	APS - Four Corners Power Plant
PM Name:	Jeff Heyman	PIC Name:	

IDENTIFYING INFORMATION

(This section is to be completed by the Originator.)

Calculation Medium: Electronic File Name:
 (Select as appropriate) Hard-copy Unique Identification:
 Number of pages
 (including cover sheet): 16

Discipline: Civil Engineering
 Title of Calculation: Hydrology Evaluation Calculation
 Calculation Originator: Gabe LeCheminant, PE
 Calculation Contributors:
 Calculation Checker: T Base, PE

DESCRIPTION & PURPOSE

The purpose of this calculation is to determine the storage capacity and runoff volumes for the basin tributary to the Lined Ash Impoundment and the Lined Decant Water Pond.

BASIS / REFERENCE / ASSUMPTIONS

Based on the PMP for the Four Corners Power Plant in New Mexico.

ISSUE / REVISION RECORD

Checker comments, if any, provided on: hard-copy electronic file Form 3-5 (MM)

No.	Description	P	S	F	Originator Initials	Date	Checker Initials	Date
0	Initial Issue	<input checked="" type="checkbox"/>	<input type="checkbox"/>	<input type="checkbox"/>	GL	8/23/11	R-T	08/11/12
1	Revised per comments	<input type="checkbox"/>	<input checked="" type="checkbox"/>	<input checked="" type="checkbox"/>	GL	8/23/11	R-T	08/11/12
2		<input type="checkbox"/>	<input type="checkbox"/>	<input type="checkbox"/>	[]	[]	[]	[]
3		<input type="checkbox"/>	<input type="checkbox"/>	<input type="checkbox"/>	[]	[]	[]	[]

Note: For a given Revision No. Check off either P (Preliminary), S (Superseding) or F (Final). If there are no revisions to the Initial Issue check off F (Final). Comments may be provided on the hard-copy calculations, electronic file or on Form 3-5 (MM).

APPROVAL and DISTRIBUTION

The calculations associated with this Cover Sheet have been checked.

Gabe LeCheminant (Gabe LeCheminant) 8/23/11
 Originator Signature Date
T Base (T Base) 08/23/11
 Checker Signature Date
Jeff Heyman Jeff Heyman, P.E., R.G. 10/10/11
 Project Manager Signature Date

Distribution:

Project Central File – Quality file folder
 Other Specify: _____

Hydrology Analysis
Lined Ash Impoundment 5280 Lift
Four Corners Power Plant
Arizona Public Service

Problem Statement

The purpose of this calculation is to determine the storage capacity and runoff volumes for the basins tributary to the Lined Ash Impoundment (LAI) 5280 Lift and the Lined Decant Water Pond (LDWP), as well as estimate the freeboard depth for the LAI and LDWP to contain the Probable Maximum Precipitation (PMP) at the Four Corners Power Plant (FCPP) in New Mexico, operated by Arizona Public Service (APS). In addition, this calculation will determine the required storage capacity and runoff volume for the North Toe area of the West Embankment.

The footprint of the LAI is being increased with construction of the 5280 Lift. The watershed basin areas for the FCPP were revised as needed from the previously computed basins in the *Lined Ash Impoundment 5270 Lift* (URS 2010). These revisions are based on updated topography provided by APS and modifications to various basins resulting from the 5280 Lift construction.

Required Deliverables

- Storage capacity for applicable basins
- Runoff volume for applicable basins
- Freeboard elevation for basin impoundments upstream of the LAI and for the LDWP

Data Available

- Previously calculated PMP for the FCPP (URS 2003)
- Previously delineated and calculated basin areas (URS 2010)
- Wave Run-up Calculation and Freeboard Analysis for the Lined Decant Water Pond (URS 2010)
- 5280 Lift alignment and proposed contours as designed by URS
- 2002, 2006, 2009, and 2010 topography of the FCPP provided by APS
- Data based on the most current topography of the slope of the operating surface in the LAI ranges from 0.0% - 0.5%

Approach

Probable Maximum Precipitation

The 72-hour general storm Probable Maximum Precipitation (PMP) was calculated as 10.9 inches in the URS 2003 report *Freeboard Evaluation of Ash Pond 6* (URS, 2003). The 72-hour PMP was calculated from these precipitation values following the stepped methodology from the Hydrometeorological Report No. 49 published by NOAA and the United States Army Corps of Engineers (NOAA 1973).

Watershed Characteristics

The previously computed watershed basins were revised based on the updated topography and the location of the LAI 5280 Lift alignment as shown in Figure 1. A summary of the revisions to the watershed basin areas is presented in Table 4. The relationships of the revised tributary basins to the fly ash ponds at the FCPP are shown below in Table 1.

TABLE 1
Relationship of Tributary Basins

Tributary Relationship	Basins
Basins contained within the Existing LAI	I ¹
Basins contained within the Existing LDWP	H
Basins contained on the abandoned Ash Pond No. 3	P
Basins with individual containment on the perimeter of the fly ash ponds	D and O
Basins outside of the fly ash pond area	A, B, and C
Basins contained within the Existing Ash Pond No. 6 (Basin E)	E
Basins tributary to Ash Pond No. 6 (Basin E)	F1, F2,G, and L4 ²
Upstream impoundment in Basin K3-M1	K3-M1 and M2-L3
Upstream impoundment in Basin K1	K1, L1 and L2
Upstream impoundment in Basin J	J and K2

- Note:** 1. Overflow from the LAI is directed to LDWP (Basin H)
2. Runoff from Basins F1, F2, G and L4 are directed to Ash Pond No. 6 (Basin E)

Water will be impounded upstream of the LAI embankment with the 5280 Lift in Basins J, K1, and K3-M1, all of which contain the runoff volumes of other basins as shown in Table 1. The LDWP is assumed to contain the runoff volumes of the LDWP (Basin H) and the LAI (Basin I) during the PMP event. The basin areas were delineated and calculated in AutoCAD based on the most currently available topography provided by APS. The curve numbers used were 95 for the natural ground basins and 100 for ash containment areas including Basins E, H, I and P. These curve numbers correspond to those used in the *Freeboard Evaluation of Ash Pond 6* (URS 2003).

Impoundments Upstream of the LAI - Storage Capacity and Runoff Volume

Impoundments within Basins J, K1, and K3-M1 will impound storm water against the LAI embankment with the 5280 Lift. Although the lowest point on the proposed crest of the LAI is 5,280 feet, the crest elevation of the LAI varies along Basins J, K1, and K3-M1 and ranges from 5,283 to 5,292 feet. The storage capacities of the impoundment in Basins J, K1, and K3-M1 were estimated to be approximately 15.7, 175.0, and 42.6 acre-feet, respectively.

The runoff volumes for the basins tributary to Basins J, K1, and K3-M1 were estimated for the 72-hour PMP of 10.9 inches. The resulting runoff volumes and freeboard estimates for the impoundments within Basins J, K1, and K3-M1 are presented in Table 2.

TABLE 2
Impoundments Upstream of the LAI

Basin	Revised Tributary Area¹ (ac)	Runoff Volume¹ (ac-ft)	Storage Capacity (ac-ft)	LAI Crest Elevation² (ft)	Maximum Water Elevation (ft)	Depth of Impounded Water in Basin (ft)	External Freeboard (ft)
J	9.0	8	15.7	5292	5288	22	4
K1	126.0	108	175.0	5285	5277	33	8
K3-M1	37.9	33	42.6	5283	5277	14	6

Note: ¹ The Revised Tributary Areas and Runoff Volumes are representative of Basins J, K1, and K3-M1, in addition to their respective tributary basins.

² The LAI 5280 Lift is named primarily to the nominal height of the west embankment, but the embankment crest does vary along the alignment due to the slope of the existing grade and to contain the ash storage within the LAI at a 0.5 percent slope to the southwest corner.

Based on the estimated runoff volumes and storage capacities, the impoundments within Basins J, K1, and K3-M1 will impound water below the crest of the LAI and will not overtop during the PMP.

The elevation-area-capacities (EAC) for the watershed basins, the LAI, and the LDWP are included in this calculation package on Tables 5 through 11. The EACs were developed based upon the interior contours for each basin or impoundment. AutoCAD was used to determine the surface area at each contour and summarized with an excel spreadsheet. The EAC for the LDWP was created based on data obtained from the dam owner's certificate.

The maximum storage elevation was determined to be the elevation that provided full containment without overflow to the LAI or adjacent basins. The Cumulative Storage number shown in bold represents the estimated total runoff volume to the identified basin.

North Toe – Storage Capacity and Runoff Volume

As part of the 5280 Lift, a pre-load (North Toe Pre-load/Buttress) will be constructed at the north toe of the west embankment (North Toe area). The North Toe area is located in Basin P, which is also the abandoned Ash Pond 3. The North Toe Buttress will reduce the existing storage capacity for the Basin P. An EAC was created for the revised Basin P, and the available storage capacity is estimated to be 46.4 acre-feet. The runoff volume for Basin P was calculated for the 72-hour PMP event. Based on the estimated runoff volume, the maximum water surface elevation will be 5,206 feet, with a maximum depth of 4 feet. The lowest point of the embankment surrounding Basin P is at an elevation of 5209 feet. Therefore, the resulting freeboard is 3 feet.

LAI Freeboard Analysis

The LAI is used for storage of hydraulically deposited solids and therefore has essentially two elevation-storage curves: solids (ash) storage and precipitation (water) storage. The impoundment ash surface of the LAI slopes to the southwest corner at approximately 0.5 percent or less. The EAC for the ash storage was developed based on historical data at the nominal crest elevations for each consecutive construction lift. Direct-precipitation will flow and be contained in the southwest corner of the LAI. For the purpose of comparison of available and required freeboard in the LAI resulting from the probable maximum flood (PMF), it is conservatively assumed that the decant tower may become blocked or otherwise damaged during a major storm event. Therefore, the freeboard analysis of the 5280 Lift of the LAI assumes that the full direct-precipitation amount will impound in the southwest corner of the LAI without drainage to the LDWP during the event.

Using the SCS Rainfall-Runoff method, the runoff volume for the LAI was estimated for the 72-hour PMP of 10.9 inches. The required storage capacity to contain the PMF within the LAI was calculated to be 123 ac-ft. In order to stay consistent with past LAI lift designs, a residual freeboard of 2.8 feet will be used. A preliminary EAC curve was generated for the water storage capacity atop the maximum operating surface in the southwest corner of the LAI and was based on the existing topography, the 5280 Lift design, and the estimated water storage contours. The maximum operating surface was estimated assuming that the operating surface will continue to slope to the southwest corner at approximately 0.5 percent or less as ash. The preliminary EAC curve was used to estimate the depth needed to contain the PMF and the residual freeboard. The estimated maximum operating surface was then adjusted according to this depth, a final EAC curve was created, and the depth was verified. The storage depth required to contain the PMF in the LAI is 2.0 feet at its deepest point in the southwest corner, and the residual freeboard is

2.8 feet. Therefore, the maximum operation level at the southwest corner is estimated to be 5275.2 feet; the PMF will be stored within the LAI with a water surface elevation of 5277.2 feet; and the remaining 2.8 feet to the crest elevation is the residual freeboard, as shown in Figure 2.

Wave generation within the LAI is not considered feasible due to a thick layer of cenospheric solids overlying the ponded water within the ash impoundment. The layer of solids shields the free water surface from wind and dissipates movement energy. Therefore, a wave runup analysis was not considered applicable to the LAI and is not included in this report.

LDWP Freeboard Analysis

The LDWP will need to contain inflow from the LAI, which is directly east of the LDWP. For the purpose of sizing the LDWP, it is conservatively assumed that the LAI will not store water and all inflow will report directly to the LDWP. The storage capacity required to contain the PMF within the LDWP was calculated to be approximately 173 ac-ft. This volume was divided by the surface area of the operating elevation of 5210 feet within the LDWP to determine the height required to store the total inflow.

TABLE 3
LDWP Freeboard

Storage Volume required within the LDWP	173	ac-ft
Surface Area at elevation 5210 ft	42.7	ac
Depth required for PMP storage in LDWP	4.1	ft
Depth required for wave run-up and setup ¹	2.0	ft
Total Freeboard required	6.1	ft
Maximum operating elevation	5209.9	ft

Note: 1. The required depth for wave run-up and setup within the LDWP was calculated as 2.0 feet in the Lined Ash Impoundment 5270 Lift Report (URS, 2010).

The maximum operating depth of the LDWP is determined from the sum of the wave run-up and setup plus the storage depth for the PMP, as calculated in Table 3. The required depth for wave run-up and setup within the LDWP was calculated as 2.0 feet in the report *Lined Ash Impoundment 5270 Lift* (URS 2010). The PMP storage required in the LDWP is 4.1 feet. Therefore, the maximum operating depth for the LDWP at the FCPP is 6.1 feet below the crest elevation of 5216.0 feet, or a maximum operating elevation of 5209.9 feet.

Results

Impoundments within Basin J, K1, and K3-M1 will impound storm water against the LAI embankment with the 5280 Lift. Based on the estimated runoff volumes and storage capacities, the impoundments within Basins J, K1, and K3-M1 will impound water below the crest of the LAI and will not overtop during the PMP.

The available storage capacity within Basin P will be reduced due to the construction of the North Toe Buttress. Based on the estimated runoff volume and the revised storage capacity, the impoundment within Basin P will impound water below the crest of the abandoned Ash Pond 3 and will not overtop during the PMP event.

The storage capacity required to contain the PMP within the LAI was calculated to be approximately 123 ac-ft. The PMP can be stored within the LAI up to approximately 5277.2 feet. This will yield a residual freeboard during the PMF of 2.8 feet.

The storage capacity required to contain the PMP within the LDWP was calculated to be approximately 173 ac-ft. The required depth for wave run-up and setup within the LDWP is 2.0 feet, and the PMP storage required in the LDWP is 4.1 feet. Therefore, the maximum operating depth for the LDWP at the Four Corners Power Plant is 6.1 feet below the crest elevation of 5216.0 feet, or a maximum operating elevation of 5209.9 feet. An electronic version of this calculation is included in the compact disc included in Appendix D.9.

Figures

Figure 1: Watershed Areas, Four Corners Power Plant

References

URS Corporation. 2010. *Revised Design Report, Lined Ash Impoundment 5270 Lift Four Corners Power Plant, Arizona Public Service Company, URS Job No. 23445725*. San Juan County, New Mexico. October 2010.

URS Corporation. 2003. *Freeboard Evaluation, Fly Ash Pond No. 6, Arizona Public Service Company, URS Job No. 23442859*. Santa Fe, New Mexico. January 14.

Table 4
Four Corners Power Plant
Arizona Public Service
Watershed Basin Summary

Watershed ID	Previous Area (sf)	Revised Area (sf)	Area (acre)	Runoff Volume (ac-ft)	Storage Capacity (ac-ft)	Comments
A	4,007,494	4,007,508	92.0	79	-	No significant change
B	1,396,203	1,395,957	32.0	27	-	No significant change
C	13,499,229	13,499,229	309.9	266	-	No significant change
D	655,303	655,584	15.1	13	-	No significant change
E	6,218,091	6,166,461	141.6	129	N/A	Reduced due to an increase in I (contains F1, F2, G, and L4)
F1	1,223,522	1,223,505	28.1	24	-	No significant change
F2	417,876	417,876	9.6	8	-	No significant change
G	763,217	730,355	16.8	14	-	Reduced due to an increase in I
H	2,090,796	2,412,896	55.4	50	517.0	Increased to include basin Q (contains H and I)
I	5,685,306	5,921,262	135.9	123	294.9	Increased due to crest height and alignment
J	215,475	215,475	4.9	4	15.7	No significant change (contains J and K2)
K1	1,942,424	2,536,856	58.2	50	175.0	Increased to include a portion of L1 and L3 (contains K1, L1, and L2)
K2	177,730	177,730	4.1	3	-	No significant change
K3	133,516	0	0.0	0	-	Absorbed into basin K3-M1
K3-M1	-	391,626	9.0	8	42.6	New basin due to construction of runaway truck ramp (contains K3-M1 and M2-L3)
L1	1,414,365	719,946	16.5	14	-	Reduced by splitting out L4
L2	2,099,602	2,232,504	51.3	44	-	Increased to include a portion of L3
L3	805,404	0	0.0	0	-	Absorbed into basins K1, L2, and M2-L3
L4	376,799	376,799	8.7	7	-	No significant change
M1	233,317	0	0.0	0	-	Absorbed into basin K3-M1
M2	626,667	0	0.0	0	-	Absorbed into basin M2-L3
M2-L3	-	1,260,622	28.9	25	-	New basin due to construction of haul road
O	260,527	254,316	5.8	5	-	Reduced due to an increase in I
P	950,434	882,673	20.3	18	46.4	Watershed area reduced due to an increase in I. Storage capacity reduced do to North Toe Pre-load construction.
Q	357,717	0	0.0	0	-	Basin Q was absorbed into basin H

Notes:

1. A curve number of 95 was used for all areas, with the exception of the impoundments on site where a curve number of 100 was used.
2. The PMF was calculated at 10.9 inches from the 2003 Ash Pond 6 Freeboard Analysis (URS, 2003).
3. The original basins and corresponding areas were taken from the 5270 Lift Design Report (URS, 2010).

Table 5
 Four Corners Power Plant
Arizona Public Service
 Elevation Area Capacity Curve

Basin J

Reservoir Elevation	Surface Area	Total Surface Area	Average Surface Area	Elevation Difference	Reservoir Storage	Cumulative Storage
(ft)	(sf)	(acre)	(acre)	(ft)	(acre-ft)	(acre-ft)
5266	18.59	0.00	0.00	0.00	0.00	0.00
5267	78.8	0.00	0.00	1.00	0.00	0.00
5268	173.83	0.00	0.00	1.00	0.00	0.00
5269	288.02	0.01	0.01	1.00	0.01	0.01
5270	460.06	0.01	0.01	1.00	0.01	0.02
5271	626.34	0.01	0.01	1.00	0.01	0.03
5272	1728.13	0.04	0.03	1.00	0.03	0.06
5273	2550.67	0.06	0.05	1.00	0.05	0.11
5274	4476.70	0.10	0.08	1.00	0.08	0.19
5275	5659.80	0.13	0.12	1.00	0.12	0.30
5276	6899.68	0.16	0.14	1.00	0.14	0.45
5277	10530.97	0.24	0.20	1.00	0.20	0.65
5278	14434.99	0.33	0.29	1.00	0.29	0.93
5279	18105.23	0.42	0.37	1.00	0.37	1.31
5280	21587.58	0.50	0.46	1.00	0.46	1.76
5281	24984.55	0.57	0.53	1.00	0.53	2.30
5282	28595.91	0.66	0.62	1.00	0.62	2.91
5283	31916.29	0.73	0.69	1.00	0.69	3.61
5284	35346.83	0.81	0.77	1.00	0.77	4.38
5285	38724.05	0.89	0.85	1.00	0.85	5.23
5286	42231.16	0.97	0.93	1.00	0.93	6.16
5287	46021.43	1.06	1.01	1.00	1.01	7.17
5288	50605.97	1.16	1.11	1.00	1.11	8.28
5289	58237.81	1.34	1.25	1.00	1.25	9.53
5290	71135.96	1.63	1.49	1.00	1.49	11.02
5291	99258.85	2.28	1.96	1.00	1.96	12.97
5292	142033.74	3.26	2.77	1.00	2.77	15.74

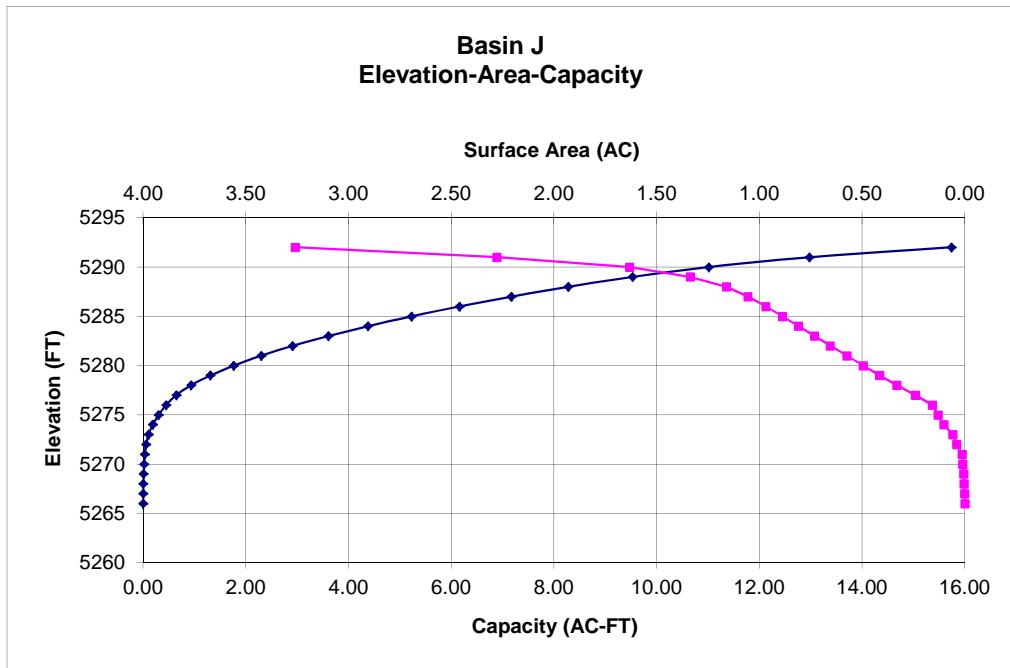

Table 6
 Four Corners Power Plant
 Arizona Public Service
 Elevation Area Capacity Curve

Basin K1

Reservoir Elevation (ft)	Surface Area (sf)	Total Surface Area (acre)	Average Surface Area (acre)	Elevation Difference (ft)	Reservoir Storage (acre-ft)	Cumulative Storage (acre-ft)
5244	4,207	0.10	0.00	0.00	0.00	0.00
5245	5,449	0.13	0.11	1.00	0.11	0.11
5246	7,738	0.18	0.15	1.00	0.15	0.26
5247	9,478	0.22	0.20	1.00	0.20	0.46
5248	14,955	0.34	0.28	1.00	0.28	0.74
5249	40,941	0.94	0.64	1.00	0.64	1.38
5250	60,222	1.38	1.16	1.00	1.16	2.54
5251	70,994	1.63	1.51	1.00	1.51	4.05
5252	83,583	1.92	1.77	1.00	1.77	5.82
5253	96,163	2.21	2.06	1.00	2.06	7.89
5254	105,499	2.42	2.31	1.00	2.31	10.20
5255	113,469	2.60	2.51	1.00	2.51	12.71
5256	119,282	2.74	2.67	1.00	2.67	15.39
5257	124,411	2.86	2.80	1.00	2.80	18.18
5258	129,536	2.97	2.91	1.00	2.91	21.10
5259	135,438	3.11	3.04	1.00	3.04	24.14
5260	142,094	3.26	3.19	1.00	3.19	27.33
5261	149,888	3.44	3.35	1.00	3.35	30.68
5262	159,259	3.66	3.55	1.00	3.55	34.23
5263	169,296	3.89	3.77	1.00	3.77	38.00
5264	180,489	4.14	4.01	1.00	4.01	42.01
5265	194,343	4.46	4.30	1.00	4.30	46.31
5266	204,262	4.69	4.58	1.00	4.58	50.89
5267	211,022	4.84	4.77	1.00	4.77	55.66
5268	218,573	5.02	4.93	1.00	4.93	60.59
5269	226,032	5.19	5.10	1.00	5.10	65.69
5270	233,525	5.36	5.27	1.00	5.27	70.97
5271	241,670	5.55	5.45	1.00	5.45	76.42
5272	250,535	5.75	5.65	1.00	5.65	82.07
5273	259,693	5.96	5.86	1.00	5.86	87.93
5274	268,877	6.17	6.07	1.00	6.07	93.99
5275	277,834	6.38	6.28	1.00	6.28	100.27
5276	286,887	6.59	6.48	1.00	6.48	106.75
5277	295,967	6.79	6.69	1.00	6.69	113.44
5278	305,481	7.01	6.90	1.00	6.90	120.35
5279	315,582	7.24	7.13	1.00	7.13	127.47
5280	326,020	7.48	7.36	1.00	7.36	134.84
5281	336,161	7.72	7.60	1.00	7.60	142.44
5282	345,754	7.94	7.83	1.00	7.83	150.27
5283	355,088	8.15	8.04	1.00	8.04	158.31
5284	364,210	8.36	8.26	1.00	8.26	166.57
5285	373,034	8.56	8.46	1.00	8.46	175.03

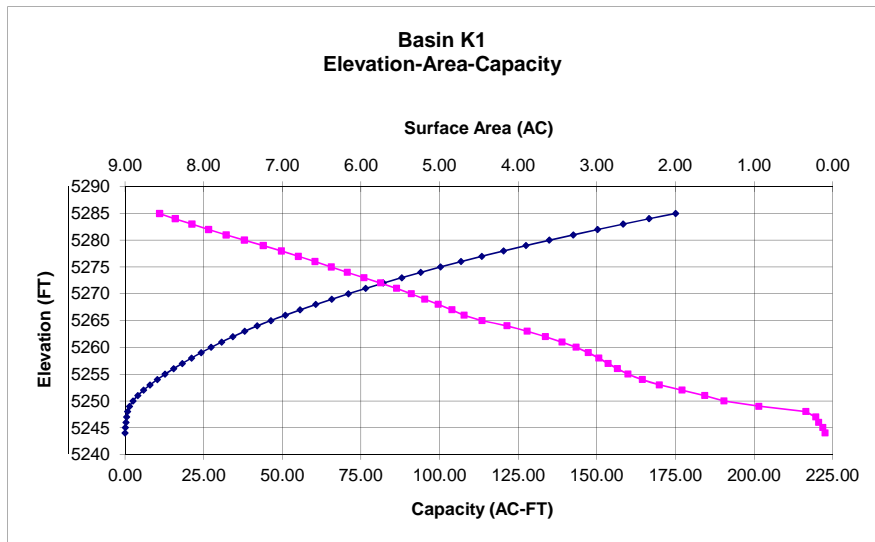

Table 7
 Four Corners Power Plant
Arizona Public Service
 Elevation Area Capacity Curve

Basin K3-M1

Reservoir Elevation	Surface Area	Total Surface Area	Average Surface Area	Elevation Difference	Reservoir Storage	Cumulative Storage
(ft)	(sf)	(acre)	(acre)	(ft)	(acre-ft)	(acre-ft)
5263	5,623	0.13	0.00	0.00	0.00	0.00
5264	37,545	0.86	0.50	1.00	0.50	0.50
5265	58,399	1.34	1.10	1.00	1.10	1.60
5266	79,266	1.82	1.58	1.00	1.58	3.18
5267	89,804	2.06	1.94	1.00	1.94	5.12
5268	98,620	2.26	2.16	1.00	2.16	7.28
5269	106,262	2.44	2.35	1.00	2.35	9.63
5270	114,117	2.62	2.53	1.00	2.53	12.16
5271	122,025	2.80	2.71	1.00	2.71	14.87
5272	129,575	2.97	2.89	1.00	2.89	17.76
5273	136,949	3.14	3.06	1.00	3.06	20.82
5274	144,352	3.31	3.23	1.00	3.23	24.05
5275	151,602	3.48	3.40	1.00	3.40	27.45
5276	158,530	3.64	3.56	1.00	3.56	31.01
5277	165,465	3.80	3.72	1.00	3.72	34.72
5278	172,473	3.96	3.88	1.00	3.88	38.60
5279	179,424	4.12	4.04	1.00	4.04	42.64

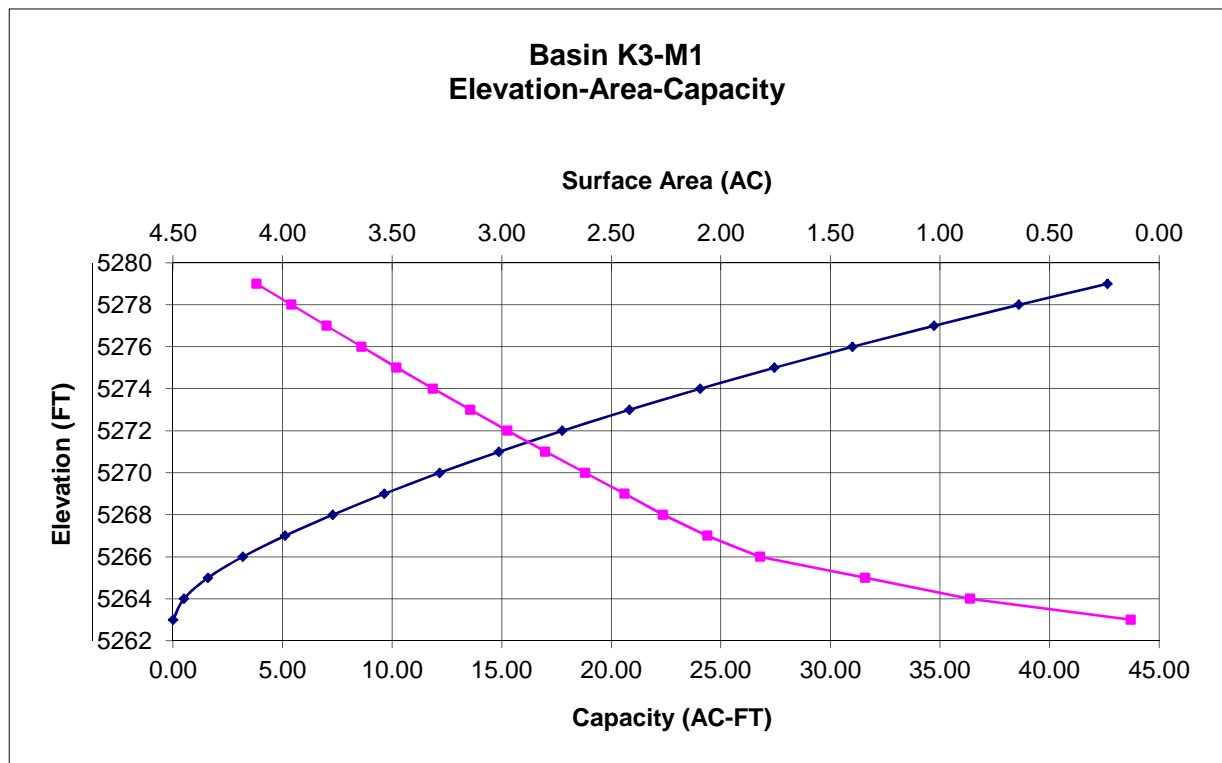

Table 8
 Four Corners Power Plant
Arizona Public Service
 Elevation Area Capacity Curve

Basin P

Reservoir Elevation (ft)	Surface Area (sf)	Total Surface Area (acre)	Average Surface Area (acre)	Elevation Difference (ft)	Reservoir Storage (acre-ft)	Cumulative Storage (acre-ft)
5202	79,995	1.84	0.00	0.00	0.00	0.00
5203	167,509	3.85	2.84	1.00	2.84	2.84
5204	285,501	6.55	5.20	1.00	5.20	8.04
5205	295,510	6.78	6.67	1.00	6.67	14.71
5206	331,303	7.61	7.19	1.00	7.19	21.90
5207	347,188	7.97	7.79	1.00	7.79	29.69
5208	363,347	8.34	8.16	1.00	8.16	37.85
5209	380,157	8.73	8.53	1.00	8.53	46.38

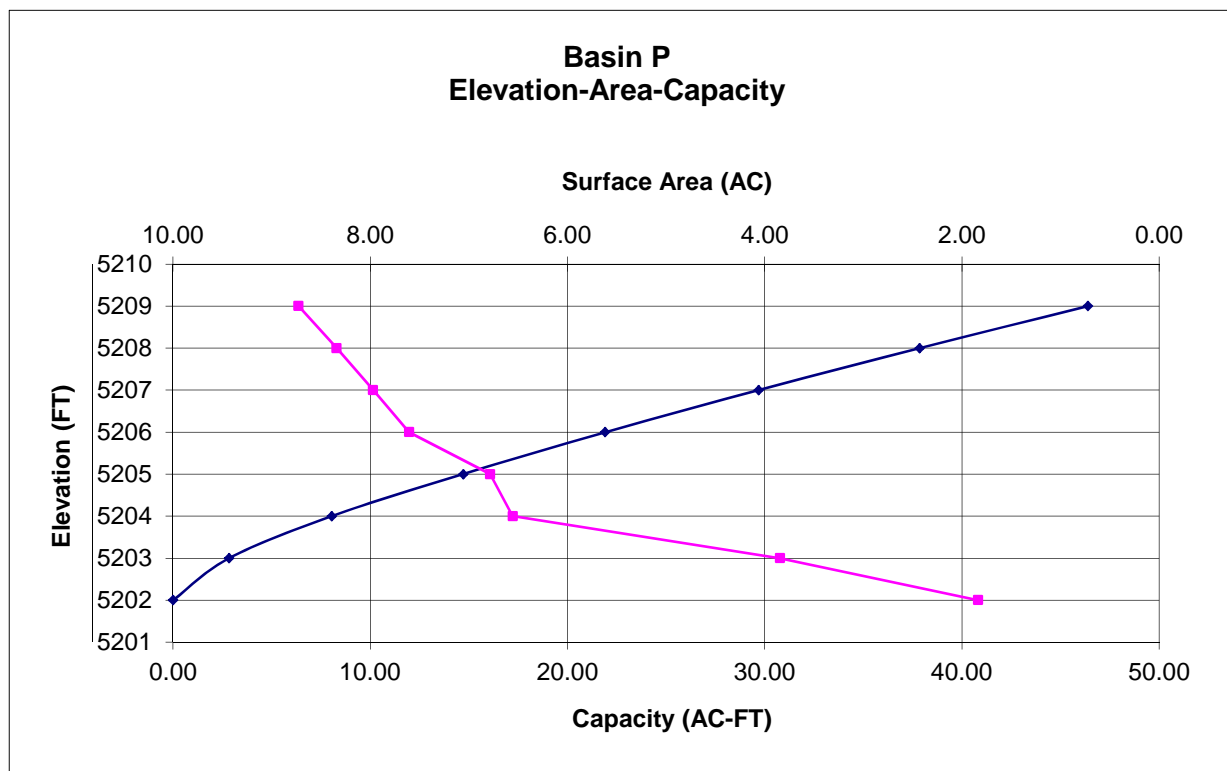

Table 9
 Four Corners Power Plant
Arizona Public Service
 Elevation Area Capacity Curve

LDWP* (Basin H)

Reservoir Elevation (ft)	Total Surface Area (acre)	Cumulative Storage (acre-ft)
5206	40	120
5213.2	45	435
5216	46	517

* From Dam Owner's Certificate

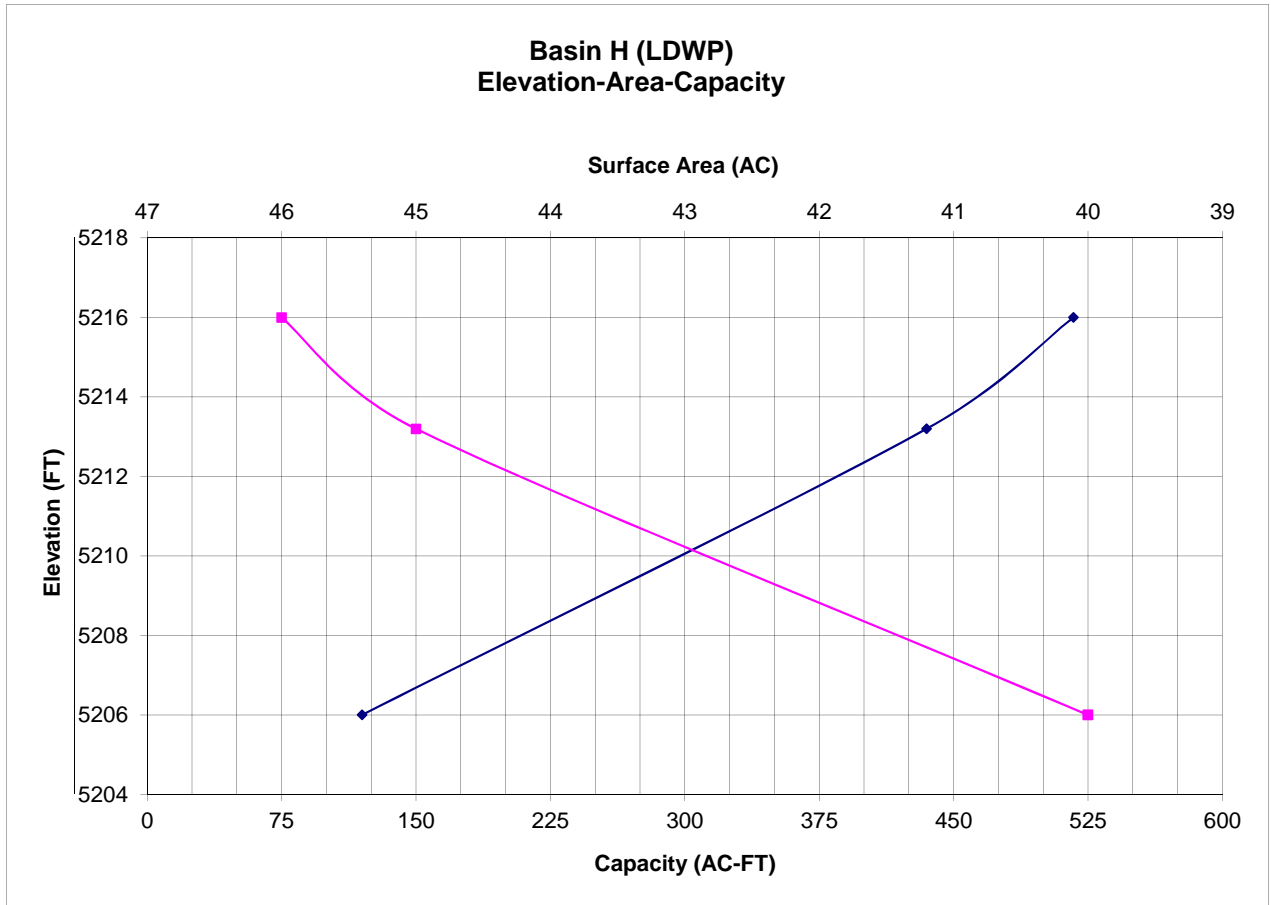

Table 10
 Four Corners Power Plant
Arizona Public Service
 Elevation-Area-Capacity

LAI (Basin I) - Water Storage

Reservoir Elevation	Surface Area	Total Surface Area	Average Surface Area	Elevation Difference	Reservoir Storage	Cumulative Storage
(ft)	(sf)	(acre)	(acre)	(ft)	(acre-ft)	(acre-ft)
5275.2	1,823,036	41.85	0.00	0.00	0.00	0.00
5276.2	2,683,394	61.60	51.73	1.00	51.73	51.73
5277.2	3,551,384	81.53	71.57	1.00	71.57	123.29
5278.2	4,250,569	97.58	89.55	1.00	89.55	212.85
5279.2	4,600,234	105.61	101.59	1.00	101.59	314.44
5280.0	4,862,684	111.63	108.62	0.80	86.90	401.33

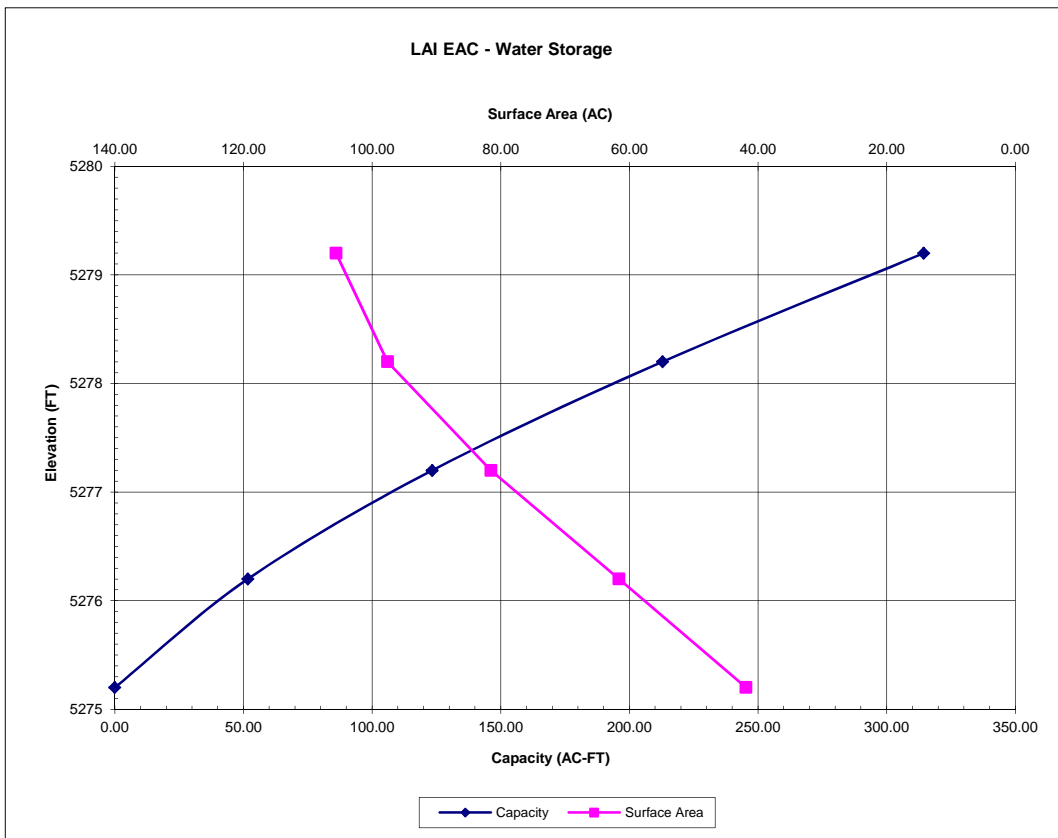
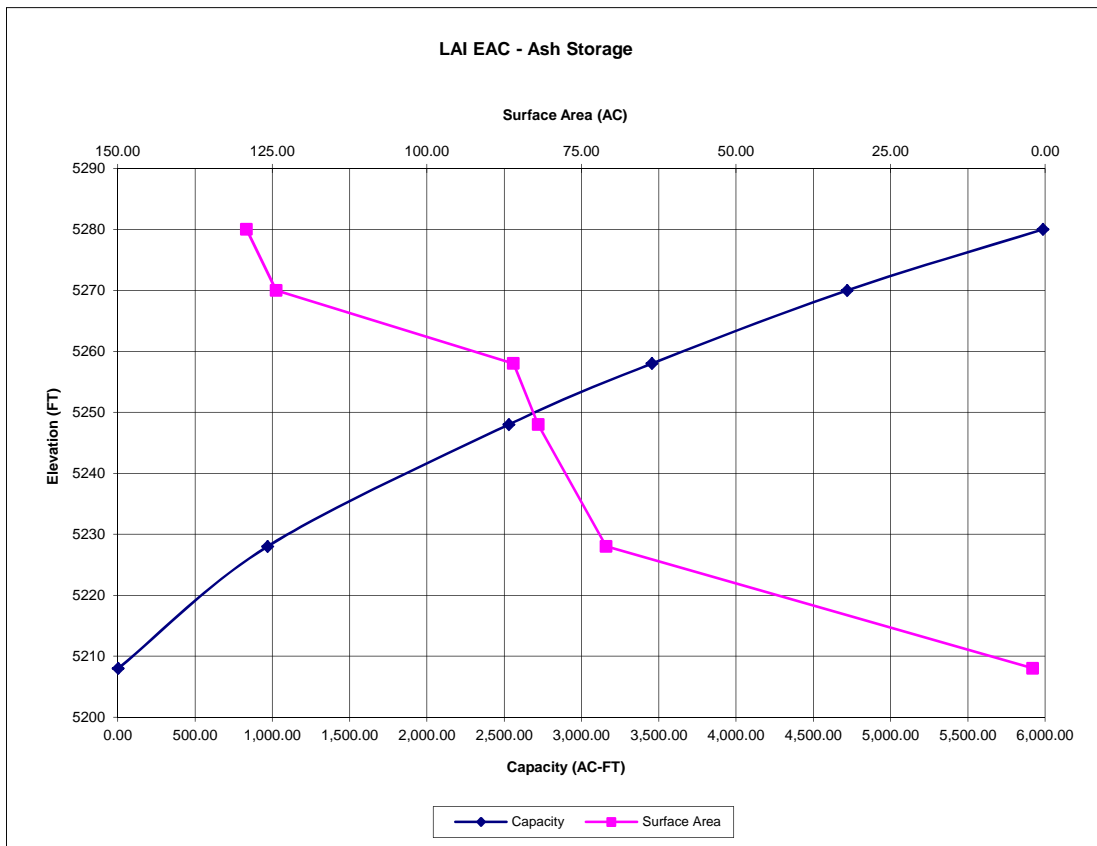

Table 11
 Four Corners Power Plant
Arizona Public Service
 Elevation-Area-Capacity

LAI (Basin I) Ash Storage

Reservoir Elevation	Surface Area	Total Surface Area	Elevation Difference	Cumulative Storage
(ft)	(sf)	(acre)	(ft)	(acre-ft)
5208	87,120	2.00	0.00	2.00
5228	3,092,760	71.00	20.00	969.00
5248	3,571,920	82.00	20.00	2,530.00
5258	3,746,160	86.00	10.00	3,456.00
5270	5,418,090	124.38	12.00	4,718.29
5280	5,626,367	129.16	10.00	5,986.02



Note: Ash Storage data for the LAI provided by APS.

Table 12
Four Corners Power Plant
Arizona Public Service
Basin Hydrology Summary

Basin J	
Storage capacity (ac-ft)	15.7
Runoff Volume from contributing basins (ac-ft)	7
Maximum Depth of water, elevation 5,288	22
Freeboard (ft) - (to the crest of the LAI)	4
Basin K1	
Storage capacity (ac-ft)	175.0
Runoff Volume from contributing basins (ac-ft)	108
Maximum Depth of water, elevation 5,277	33
Freeboard (ft) - (to the crest of the LAI)	8
Basin K3-M1	
Storage capacity (ac-ft)	42.6
Runoff Volume from contributing basins (ac-ft)	33
Maximum Depth of water, elevation 5,277	14
Freeboard (ft) - (to the crest of the LAI)	6
Basin P	
Storage capacity (ac-ft)	19.6
Runoff Volume from contributing basins (ac-ft)	18
Maximum Depth of water, elevation 5,206	4
Freeboard (ft) - (to the top of the Ash Pond 3 embankment)	3
Lined Ash Impoundment (Basin I)^A	
Runoff Volume from contributing basins (ac-ft) ^B	123
Maximum Depth of water, elevation 5,277.2	2
Freeboard (ft)	1.8
Lined Decant Water Pond (Basin H)	
Runoff Volume from contributing basins (ac-ft) ^C	173
Maximum Depth of water, elevation 5,210.2 ^D	8
Freeboard (ft)	See Note E
Notes:	
A. The storage volume in the LAI begins at elevation 5277 feet to account for the assumed existing ash elevation.	
B. Freeboard estimate for the LAI is estimated for the PMP event only.	
C. Estimates of runoff volume for Basin H assumes that it includes Basins H and I	
D. Maximum Depth of water in LDWP is assumed to be 8 feet.	
E. Freeboard is to be calculated based on previously calculated PMP and wave run-up.	

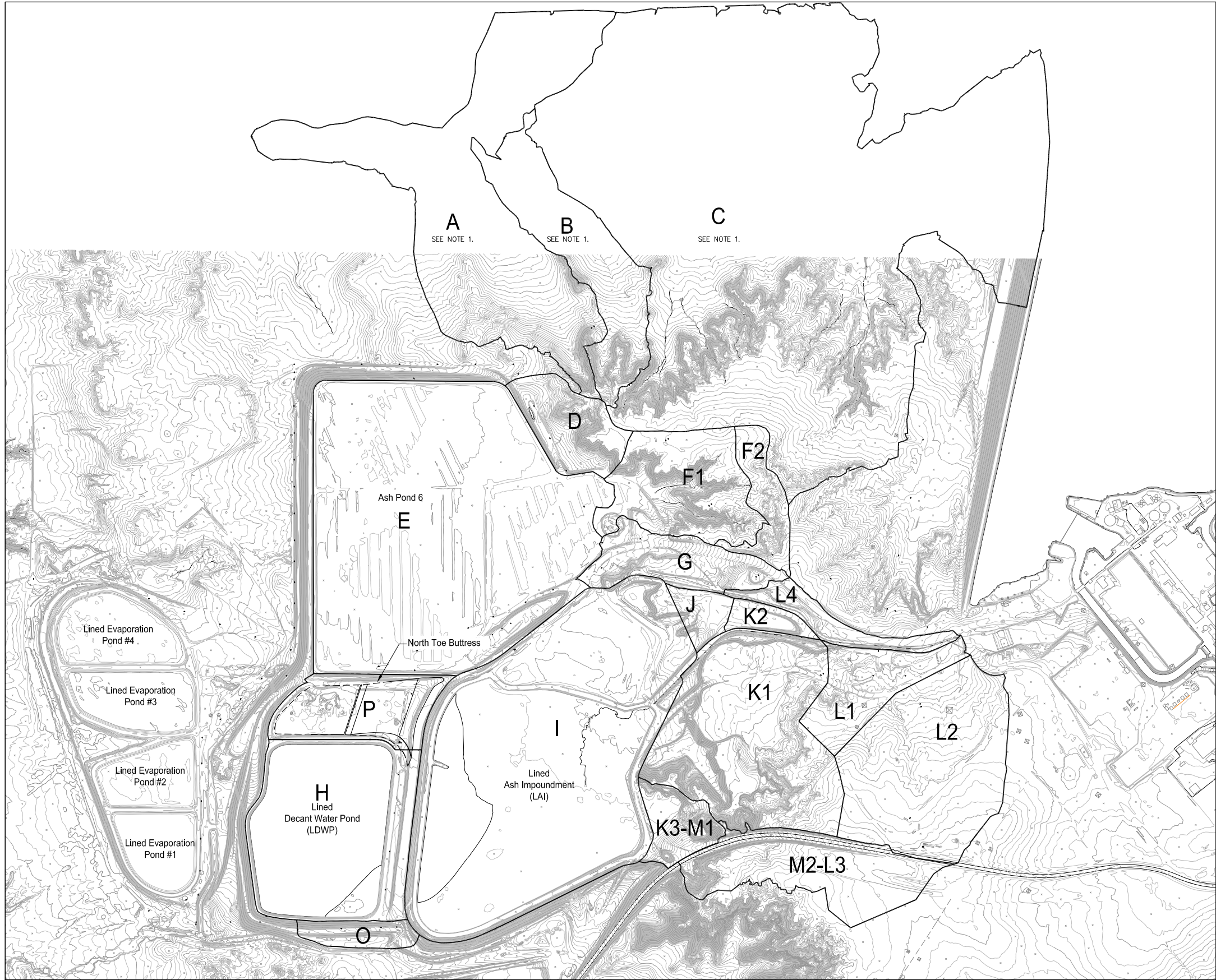

LEGEND

— WATERSHED BOUNDARY

C WATERSHED BASIN ID

BASIN ID	BASIN AREA	RUNOFF VOLUME	TOTAL RUNOFF VOLUME	STORAGE CAPACITY
WATERSHED SCHEMATIC SYMBOL				

REFERENCE
 EXISTING TOPOGRAPHY PROVIDED BY APS,
 FLOWN BY AERIAL MAPPING CO. ON MAY 12, 2010.

DATUM INFORMATION
CONTROL POINTS:
 HV-53
 SOUTHERN CALIFORNIA EDISON (SCE) BRASS CAP

NORTHING	EASTING	ELEVATION
N2,070,581.505	E2529275.542	5331.214'

NEW MEXICO STATE PLANE
 TRANSVERSE MERCATOR—WEST ZONE
 N.A.D. 1983, NAVD 88

NOTE:
 ELEVATIONS SHOWN ON THIS FIGURE ARE APPROXIMATELY 3' HIGHER THAN THOSE USED IN THE APS DRAWING SET 161907, WHICH IS IN N.A.D. 1927, N.G.V.D. 1929.

BASINS NOT CONTRIBUTING TO THE ASH IMPOUNDMENTS

A	B	C	D
92.0 AC	32.0 AC	309.9 AC	15.1 AC
79 AC-FT	28 AC-FT	266 AC-FT	13 AC-FT
79 AC-FT	28 AC-FT	266 AC-FT	13 AC-FT

ROUTING OF BASINS IMPACTING THE ASH IMPOUNDMENTS

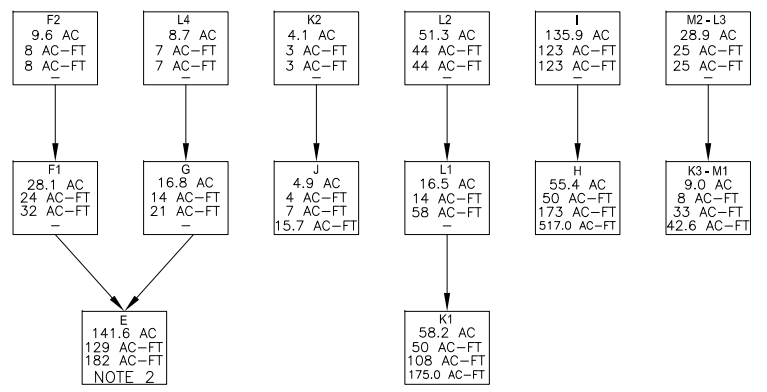

BASINS WITH DIRECT PRECIPITATION ONLY

O	P
5.8 AC	20.3 AC
5 AC-FT	18 AC-FT
5 AC-FT	18 AC-FT
—	19.6 AC-FT

NOTE:
 1. AREAS OUTSIDE LIMITS OF THE CURRENT TOPO. ASSUMED NO SIGNIFICANT CHANGES SINCE THE REPORT 5270 LIFT DESIGN REPORT (URS 2010)
 2. ASSUMED TO BE STORED WITHIN THE FREEBOARD OF ASH POND 6.
 3. RUNOFF VOLUMES ARE BASED ON PROBABLE MAXIMUM PRECIPITATION.

Hydrologic Watershed Routing
 Arizona Public Service
 Four Corners Power Plant
 Figure 1



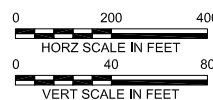
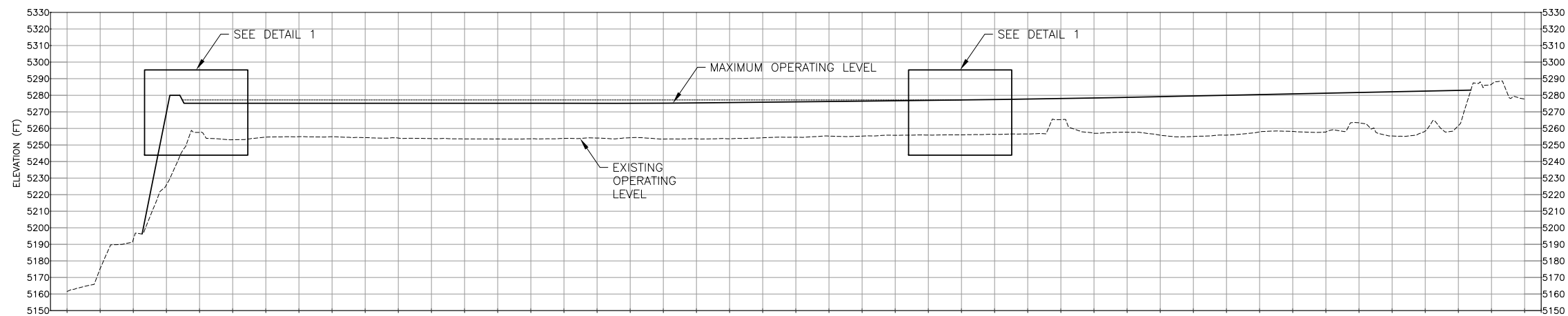
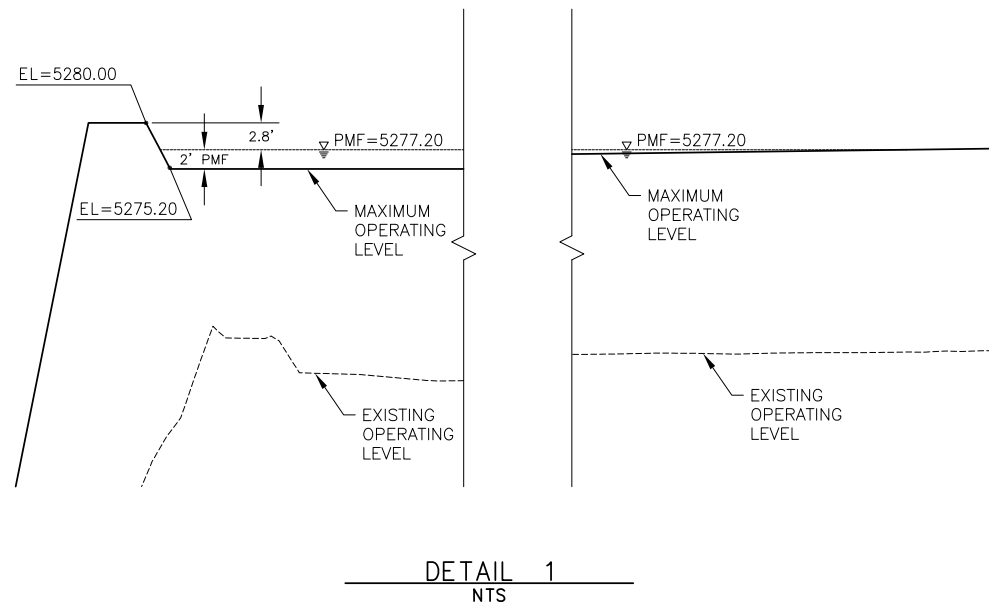
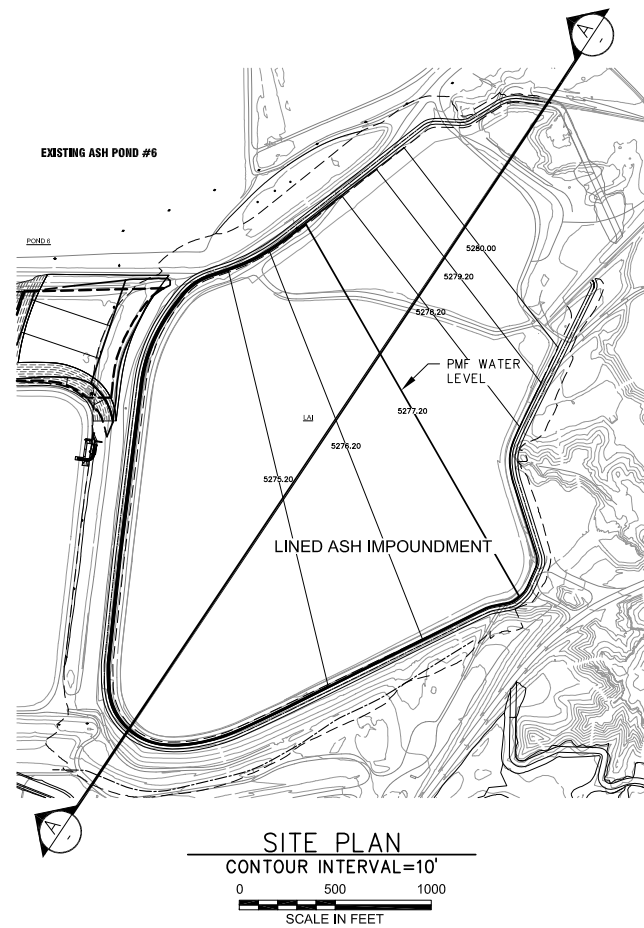

REFERENCE:
EXISTING TOPOGRAPHY PROVIDED BY APS,
FLOWN BY AERIAL MAPPING CO, ON MAY 12, 2010.

DATUM INFORMATION
CONTROL POINTS:
HV-53
SOUTHERN CALIFORNIA EDISON (SCE) BRASS CAP
NORTHING EASTING ELEVATION
N2,070,519.859 E 306,365.846 5328.150'

NEW MEXICO STATE PLANE
TRANSVERSE MERCATOR-WEST ZONE
N.A.D. 1927, N.G.V.D. 1929

LAI Freeboard Exhibit
Arizona Public Service
Four Corners Power Plant
Figure 2



REFERENCES



January 14, 2003

New Mexico Office of the State Engineer
Attention: Elaine Pacheco, P.E. Chief Dam Safety Bureau
130 South Capitol Street
NEA Building
PO Box 25102
Santa Fe, NM 87504-5102

Re: Freeboard Evaluation
Fly Ash Pond No. 6
Arizona Public Service Company
URS Job No. 23442859

Dear Ms. Elaine Pacheco, P.E.

INTRODUCTION

URS Corporation is under contract with the Arizona Public Service Company (APS) to evaluate the freeboard for Fly Ash Pond No. 6 at the Four Corners Generating Facility in San Juan County, New Mexico. This letter has been prepared to demonstrate that this facility will maintain the minimum required freeboard as set forth by the New Mexico Office of the State Engineer (State).

FACILITY DESCRIPTION

The Four Corners Generating Facility currently deposits fly ash into Pond No. 6. Ash Pond Nos. 3, 4, and 5 are not currently in use. APS is proposing to construct the Lined Ash Impoundment and Lined Decant Water Pond over Pond Nos. 3 and 4. An overview of the ash pond system is provided on Drawing 1.

CURRENT FREEBOARD REQUIREMENTS

The current freeboard requirement for Pond No. 6 is detailed in a letter from the State to Davies & Moore dated June 7, 1990. The State required five (5) feet of freeboard with 2.2 feet allocated for storage of half the 24-hour Probable Maximum Flood (PMF). Therefore, 2.8 feet of residual freeboard must be maintained from the top of the flood pool and the lowest point on the dam crest.

URS Corporation
7720 North 16th Street, Suite 100
Phoenix, AZ 85020
Tel: 602.371.1100
Fax: 602.371.1615



New Mexico Office of the State Engineer
January 14, 2003
Page 2

The basis for development of the original freeboard requirement was detailed in the following documents:

1. A letter from Dames & Moore dated May 29, 1990 titled *Freeboard Requirements, Bottom Ash Dams #3 and #6*.
2. *Report – Raising Ash Dams 3 and 6*, Dames and Moore, August 29, 1990.

FREEBOARD EVALUATION

The freeboard evaluation was performed using a HEC-1 model that was modified from the original model developed by Dames & Moore (Reference 2). The modifications include the use of a larger PMF storm event and changes to watershed boundaries. In addition, the HEC-1 model was modified to account for flows that previously passed from Pond No. 5 to Pond Nos. 3 and 4 will be diverted to Pond No. 6 with the construction of the Proposed Lined Ash Impoundment.

Precipitation Estimate

As per the request of the State, the freeboard evaluation was based on the runoff resulting from the 72-hour Probable Maximum Precipitation (PMP). The 72-hour PMP was estimated to be 10.9 inches using the procedures provided within the Hydrometeorological Report No. 49. Details of the PMP calculation are provided in Appendix A.

Watershed Characteristics

The watershed characteristics used in the HEC-1 model are curve number, lag time, and basin area. Development of these characteristics is detailed in the calculation provided in Appendix B.

The curve number used for natural ground and ash ponds was 95, which was taken from the previous model (Reference 2). This high curve number is appropriate for modeling an extreme storm such as the PMP. Pond No. 6 was given a curve number of 100 because it would be entirely covered by ponding water, and basins tributary to Pond No. 5 were considered to have impervious area for those portions covered by ponding water.



New Mexico Office of the State Engineer
January 14, 2003
Page 3

The lag time for the basins was calculated using the Kirpich Formula, as provided in *Drainage Design Criteria for New Mexico State Highway & Transportation Department Projects* (NMSHTD 1998).

Basin areas were delineated and calculated using the topographic map provided by APS (see Drawing 1). A description of the tributary relationship of the basins is provided in Table 1.

TABLE 1
Relationship of Tributary Basins

Tributary Relationship	Basins	Comments
Basins tributary to Ash Pond No. 6	E, D, F1, F2, G, and flow routed through Pond No. 5 (Basin J)	Flow is routed from Pond No. 5 to Pond No. 6 through a proposed spillway structure.
Basins tributary to Ash Pond No. 5	J, K, L1, L2, and L3	
Basins contained on the abandoned Ash Pond No. 3	P and Q	
Basins contained within the Proposed Lined Decant Water Pond	H	
Basins contained within the Proposed Lined Ash Impoundment	I	
Basins with individual containment on the perimeter of the fly ash ponds	D, M1, M2, and O	
Basins outside of the fly ash pond area	A, B, and C	

Storage Capacity

The storage capacity of Pond No. 6 is estimated to be approximately 915 acre-feet. The elevation-storage data is based on a 2001 topographic survey, and is provided in Appendix C. The bottom elevation is 5,212 feet. The lowest point on the dam crest is 5,225 feet. The elevation and storage volume that correspond to 2.8 feet of residual freeboard are 5,222.2 feet and 547 acre-feet.

New Mexico Office of the State Engineer
January 14, 2003
Page 4

HEC-1 Modeling

The precipitation and watershed characteristics were input to the HEC-1 computer model. The model was developed to estimate stormwater runoff for the PMP to Pond No. 6, including runoff routed through Pond No. 5. No upstream diversions were considered for the PMP model. The HEC-1 model is provided in Appendix B.

Results

The runoff volume to Pond No. 6 resulting from the 72-hour PMP is 344 acre-feet. Based on the most recent topographic mapping, the storage volume of 344 acre-feet results in 4.4 feet of residual freeboard. Pond No. 6 has 547 acre-feet of available storage capacity below the residual freeboard requirement of 2.8 feet. Therefore, Pond No. 6 can continue to deposit fly ash up to a bottom elevation of 5,219.3 feet and maintain the residual freeboard required by the State.

The Proposed Lined Decant Water Pond and Lined Ash Impoundment will be operated in such a manner to maintain 2.8 feet of residual freeboard following the 72-hour PMP. These proposed impoundments will not have upstream watersheds and will only receive direct precipitation. The storage of stormwater runoff on Pond No. 3, in the areas north and east of the Proposed Lined Decant Water Pond, will also maintain 2.8 feet of residual freeboard following the 72-hour PMP.

UPSTREAM DIVERSION

The hydrologic model developed for the freeboard evaluation did not include the diversion of stormwater runoff from natural ground upstream of the fly ash ponds. APS is currently evaluating the feasibility of diverting stormwater runoff from these areas for water rights reasons. The storm used for sizing these diversions will likely be less than the PMP and more in the range of a 25-year to 100-year event. Drawing 1 shows potential locations of diversion channels. The runoff volume estimated in the freeboard evaluation is conservative in that it assumes either no upstream diversion or the overtopping of diversion channels designed for smaller events.

◆ ◆ ◆



New Mexico Office of the State Engineer
January 14, 2003
Page 5

Should you have any questions regarding the content of this letter please contact Byron Conrad of APS at (602) 371-5953 or Todd Ringsmuth at (602) 861-7425.

Sincerely,

URS Corporation

Todd E. Ringsmuth, P.E.
Senior Engineer

Donald T. Lopez, P.E.
Senior Civil/Geotechnical Engineer

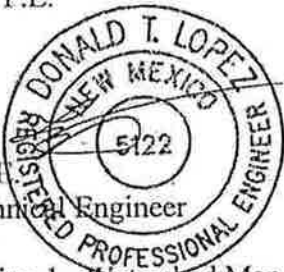

Attachments: Drawing 1 - Watershed Map
Appendix A - Precipitation Estimate Calculation
Appendix B - HEC-1 Model
Appendix C - Pond No. 6 Elevation-Storage Data

cc: Byron Conrad - Arizona Public Service Company
File

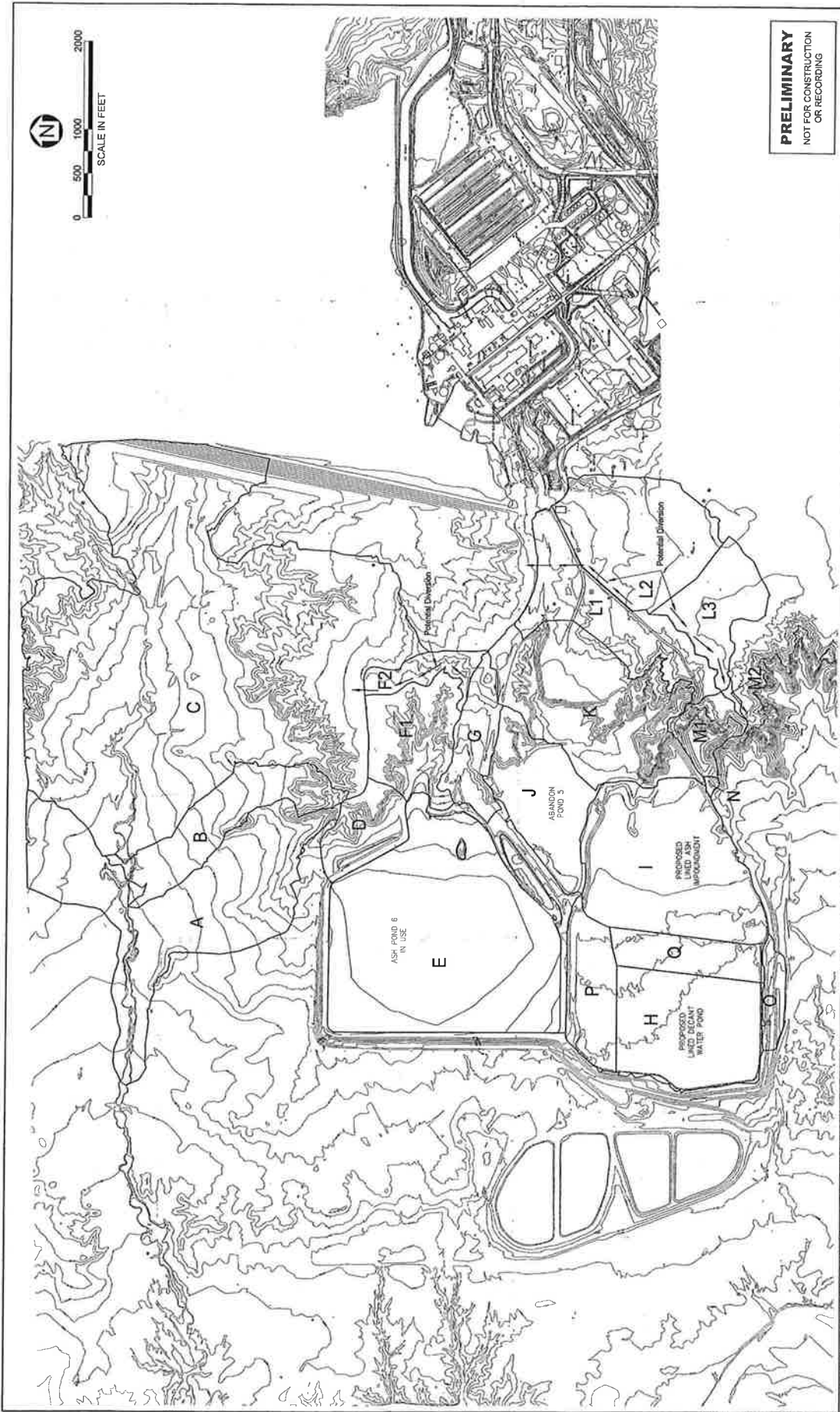

PRELIMINARY
NOT FOR CONSTRUCTION
OR RECORDING

FREEMAN EVALUATION FLY ASH POND No. 6	
WATERSHED MAP	
DATE	1-03
DESIGNED BY	JPH
CHECKED BY	JPH
APPROVED BY	JPH
DRAWING NO.	1
REV.	A

URS	
SCALE	AS NOTED
REVISION	DATE
1	1-03
2	1-03
3	1-03
4	1-03

REFERENCES	REVISIONS	REVISIONS
1. PRELIMINARY PROPOSAL FOR ASH PONDING No. 6, DATED 5-15-00	A	1.00/03 PRELIMINARY DESIGN
	A	1.00/03 PRELIMINARY DESIGN
	A	1.00/03 PRELIMINARY DESIGN
	A	1.00/03 PRELIMINARY DESIGN
	A	1.00/03 PRELIMINARY DESIGN
	A	1.00/03 PRELIMINARY DESIGN

CALCULATION COVER SHEET

Client: ARIZONA PUBLIC SERVICES Project Name: Fry Mesa Dams

Project/Calculation Number: _____

Title: 100-yr, 24-hr, and pump calc.

Total Number of Pages (including cover sheet): 36

Total Number of Computer Runs: 3

Prepared by: Patrick Gorman Date: 13 Sep 02

Checked by: [Signature] Date: 15-1-02

Description and Purpose:

Develop rainfall values for modeling purposes

Design Basis/References/Assumptions

SEE ATT.

Remarks/Conclusions/Results:

SEE ATT.

Calculation Approved by: Donald T. Lopez PE, September 27, 2002
Project Manager/Date
Sr. Civil / Geotechnical Engineer, URS AC6, NV

Revision No.:	Description of Revision:	Approved by:
_____	_____	_____
_____	_____	_____
_____	_____	_____

Project Manager/Date

APS Fly Ash Dams
100-year, 24-Hr Storm and PMP Precip. Calc.
September 13, 2002

Purpose: Estimate the 100-year, 24-hour precipitation and Probable Maximum Precipitation (PMP) values in order to model the stormwater runoff for the fly ash ponds at the APS facility near Farmington, NM.

Approach:

1. Calculate the 100-yr, 24-hr precipitation values for the site.
2. Calculate the general storm PMP values for the site.
3. Convert the PMP values to a 72-hr event using the Modified NOAA_SCS Rainfall Distribution Worksheet.

(1) 100-yr, 24-hr Precipitation-

The approach used to calculate the precipitation values follows that method provided within the Precipitation-Frequency Atlas of the Western United States (Vol. IV-New Mexico) published by the National Oceanic and Atmospheric Administration (NOAA), 1973.

The methodology consists of:

- Identifying the region of the state in which the subject property lies.
- Determining from precipitation maps the following precipitation values:
 - 2-yr, 6-hr
 - 2-yr, 24-hr
 - 100-yr, 6-hr
 - 100-yr, 24-hr
- Apply the values above to the provided formulas to estimate the following:
 - 2-yr, 1-hr
 - 100-yr, 1-hr
 - 2yr, 2-hr
 - 2-yr, 3-hr
 - 2-yr, 12-hr
 - 100-yr, 2-hr
 - 100-yr, 3-hr
 - 100-yr, 12-hr
- Apply the reduction values (Table 12) to estimate the precipitation values:
 - 2-yr, 5-min
 - 2-yr, 15-min
 - 100-yr, 5-min
 - 100-yr, 15-min

(2) Probable Maximum Precipitation (PMP)-

The approach used to calculate the precipitation values follows that method provided within the Hydrometeorological Report No. 49 (HR-49), published by the National Oceanic and Atmospheric Administration (NOAA) and the United States Army Corps of Engineers.

HR-49 provides a stepped methodology, which has been followed in order to complete the development of the General Storm. For the purpose of clarity explaining the calculation method, those instructional steps are includes as pages 29 and 30 of this calculation package. The associated worksheet (page 31) has also been converted into an electronic spreadsheet to ease the calculation of the values.

(3) 72-Hr PMP Adjustment-

A rainfall hyetograph was developed for the site by using the SCS unit Hydrograph method, referenced within the New Mexico State Highway and Transportation Department Drainage Design Manual (Dec, 1995- updated 1998). The 100-yr, 24-hr rainfall values are used to distribute the 72-hr PMP values derived during the previous step. The resultant hyetograph was then input to the HEC-1 files for peak storage volume estimation.

Data Available:

- NOAA precipitation Atlas,
- Site Location
- Hydrometeorological Report No. 49 (HR-49)
- NMSHTD Drainage Manual (Dec. 1995, revised 1998)

Results:

(1) 100-yr, 24-hr Precipitation-

	5-MIN	15-MIN	60-MIN	2-HR	3-HR	6-HR	12-HR	24-HR
2-YEAR	0.21	0.38	0.59	0.66	0.71	0.80	0.90	1.00
100-YEAR	0.56	1.09	1.75	1.84	1.89	2.00	2.20	2.40

(2) Probable Maximum Precipitation (PMP)-

6-hr	12-hr	18-hr	24-hr	48-hr	72-hr	
5.3	6.8	7.7	8.3	10.1	10.9	in

(3) 72-Hr PMP Adjustment-

See page 32 of this calculation package.

Arizona Public Service Co.
Four Corners Fly Ash Ponds

Precipitation Data Calculation

PART A

P _{2,6'}	0.8
P _{2,24'}	1.0
P _{100,6'}	2.0
P _{100,24'}	2.4

PART B

P _{2,1'}	0.6
P _{100,1'}	1.8
P _{2,2'}	0.7
P _{2,3'}	0.7
P _{2,12'}	0.9
P _{100,2'}	1.8
P _{100,3'}	1.9
P _{100,12'}	2.2

PART C

Region	2
--------	---

Duration	Ratio	
	2-yr	100-yr
5	0.29	0.29
15	0.57	0.57

P _{2,5'}	0.2
P _{2,15'}	0.3
P _{100,5'}	0.5
P _{100,15'}	1.0

	5-MIN	15-MIN	60-MIN	2-HR	3-HR	6-HR	12-HR	24-HR
2-YEAR	0.17	0.34	0.59	0.66	0.71	0.80	0.90	1.00
100-YEAR	0.51	1.00	1.75	1.84	1.89	2.00	2.20	2.40

From Precip Maps

Arizona Public Service Co.
Four Corners Fly Ash Ponds

Region is West
of the Sangre
de Cristo Mts.

Precipitation Data Calculation

Part B is calculated using
Part B Data & Formulas from Table 11

	A	B	C	D	E	F	G	H	I
1	PART A			PART B			PART C		
2	P _{2,6'}	0.8		P _{2,1'}	=-0.011+0.942*B2^2/B3		Region	2	
3	P _{2,24'}	1		P _{100,1'}	=0.494+0.755*B4^2/B5				
4	P _{100,6'}	2		P _{2,2'}	=0.341*B2+0.659*E2		Duration	Ratio	
5	P _{100,24'}	2.4		P _{2,3'}	=0.569*B2+0.431*E2			2-yr	100-yr
6				P _{2,12'}	=0.5*B2+0.5*B3	✓	5	0.29	0.29
7				P _{100,2'}	=0.341*B4+0.659*E3		15	0.57	0.57
8				P _{100,3'}	=0.569*B4+0.431*E3				
9				P _{100,12'}	=0.5*B4+0.5*B5	✓	P _{2,5'}	=H6*E2	
10							P _{2,15'}	=H7*E2	
11							P _{100,5'}	=I6*E3	
12							P _{100,15'}	=I7*E3	
13									
14									
15		5-MIN	15-MIN	60-MIN	2-HR	3-HR	6-HR	12-HR	24-HR
16	2-YEAR	=H9	=H10	=E2	=E4	=E5	=B2	=E6	=B3
17									
18	100-YEAR	=H11	=H12	=E3	=E7	=E8	=B4	=E9	=B5

From
TABLE
12

TRANSFERS values to table for quick REFERENCE.

Precipitation-Frequency Atlas of the

J. F. Miller, R. H. Frederick, and R. J. Tracey

WESTERN UNITED STATES

Volume IV—New Mexico



NATIONAL WEATHER SERVICE
GEORGE P. CRESSMAN, Adminr.
SILVER SPRING, MD - 1973

U.S. DEPARTMENT OF COMMERCE
Frederick B. Dent, Secretary

NATIONAL OCEANIC AND ATMOSPHERIC ADMINISTRATION
Robert M. White, Administrator

New Mexico

7

Discussion of Maps

Figures 19 through 30 present precipitation-frequency maps for New Mexico for 6- and 24-hr durations for return periods of 2, 5, 10, 25, 50, and 100 yrs. The isopluvial maps represent the 360- and 1,440-min durations for the partial-duration series. Data were tabulated for clock and observation-day intervals for the annual series and were adjusted by the empirical factors given in the ANALYSIS section.

Isoline interval. The isoline interval selected was designed to provide a reasonably complete description of the isopluvial pattern in various regions of the State. The intervals on the maps for the 24-hr duration are 0.2 in. for precipitation-frequency values up to 3.0 in., 0.4 in. between 3.0 and 5.0 in., and 0.5 in. over 5.0 in. For the 6-hr duration, the isopluvial interval is 0.1 in. for precipitation-frequency values below 1.6 in. at 2- and 5-yr return periods, below 2.0 in. at longer return periods, 0.2 in. for values to 3.0 in., and 0.4 in. above 3.0 in. Dashed intermediate lines have been placed between widely separated isolines and in regions where a linear interpolation between the normal isopluvial interval would lead to erroneous interpolation. "Lows" that close within the boundaries of a particular map have been hatched on the low-valued side of the isoline.

Importance of snow in precipitation-frequency values. The maps in this Atlas represent frequency values of precipitation regardless of type. For many hydrologic purposes, precipitation falling as rain must be treated in a different manner from that falling as snow. The contribution of snow amounts to precipitation-frequency values in New Mexico and the Rocky Mountain States (roughly Montana, Wyoming, Colorado, New Mexico, and Utah) was investigated. In this area, there were about 50 stations per state having 10 to 15 yrs of observations of snowfall as part of the precipitation observing program. For each such station, two data series were formed as discussed under Interpretation of Results, Importance of Snow in Estimating Frequency Values.

A ratio was formed of the 2-yr 24-hr value for the returning maximum annual amounts without regard to precipitation and the 2-yr 24-hr value for the series occurrences eliminated. Only five of the New Mexico showed any difference between the two series, and at two the difference was less than 5 percent. Four of the stations differences were at elevations from 7,000 to 8,700 ft. the stations showing no difference between the two series at elevations well over 8,000 ft. Therefore, elevation appear to be a factor. The fifth station (Sandia Crest at 10,675 ft) has the largest ratio. It is possible that at over 9,000 ft snow occurrences may contribute as much as 10 percent to the 2-yr 24-hr precipitation-frequency values. There are insufficient data to verify or further quantify this.

Two indirect measurements of the importance of snow were also considered. The first was the seasonal variation of the number of days with precipitation equal to or greater than 0.5 in. If most maximum annual events exceed this threshold, it is considered appropriate. In New Mexico, over 70 percent of the maximum annual events occur during the May through October period at elevations above 6,000 ft, and over 80 percent of such days occur during the same period at elevations less than 6,000 ft. The second indirect measurement was the percentage of the maximum annual events that occur during the May to October period. Even at elevations greater than 6,000 ft, over 80 percent of the maximum annual events occur during this period.

The conclusion was drawn that, except as noted above, snow is not an important factor in the precipitation-frequency values for New Mexico.

Procedures for Estimating Values for Durations Other Than 6 and 24 Hrs

The isopluvial maps in this Atlas are for 6- and 24-hour durations. For many hydrologic purposes, values for other durations are necessary. Such values can be estimated using the 6-

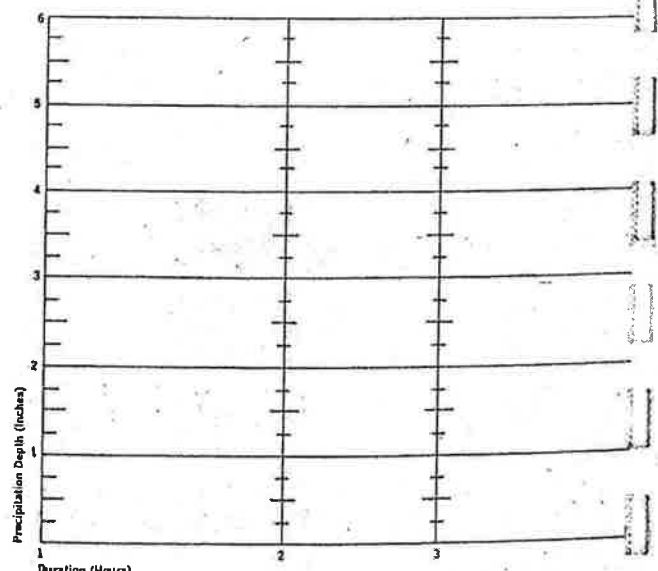
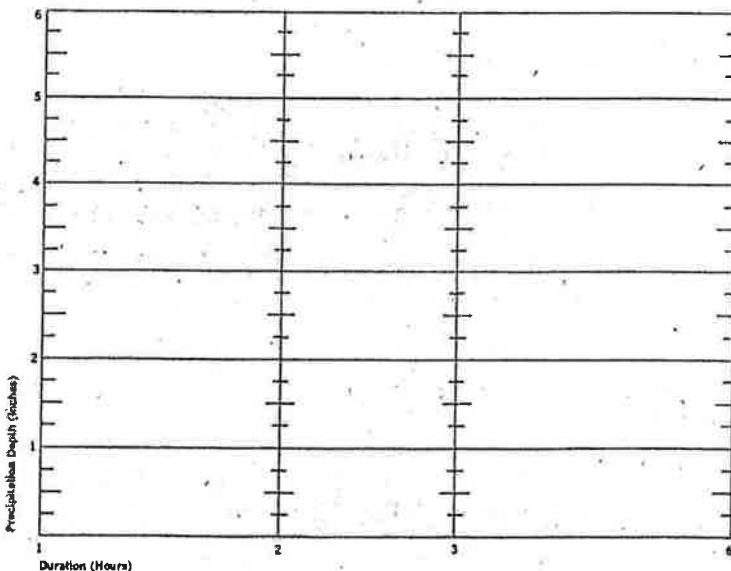

FIG 11. Equations for estimating 1-hr values in New Mexico with statistical parameters for each equation

Region of applicability*	Equation	Corr. coeff.	No. of stations	Mean of computed stn. values (inches)	Standard error of estimate (inches)
Mexico east of generalized east of Sangre de Cristo Range and Sacramento Mountains (1)	$Y_2 = 0.218 + 0.709[(X_1)(X_1/X_2)]$ $Y_{100} = 1.897 + 0.439[(X_3)(X_3/X_4)] - 0.008Z$	0.94	75	1.01	0.074
Mexico west of generalized east of Sangre de Cristo Range and Sacramento Mountains (2)	$Y_2 = -0.011 + 0.942[(X_1)(X_1/X_2)]$ $Y_{100} = 0.494 + 0.755[(X_3)(X_3/X_4)]$.96 .90	86 85	0.72 1.96	.085 .290

* Numbers in parentheses refer to geographic regions shown in figure 18. See text for more complete description.

List of variables

- Y₂ = 2-yr 1-hr estimated value
- Y₁₀₀ = 100-yr 1-hr estimated value
- X₁ = 2-yr 6-hr value from precipitation-frequency maps
- X₂ = 2-yr 24-hr value from precipitation-frequency maps
- X₃ = 100-yr 6-hr value from precipitation-frequency maps
- X₄ = 100-yr 24-hr value from precipitation-frequency maps
- Z = point elevation in hundreds of feet

maps and the empirical methods outlined in the following sections. The procedures detailed below for obtaining 1-, 2-, and 3-hr estimates were developed specifically for this Atlas. The procedures for obtaining estimates for less than 1-hr duration and for 12-hr duration were adopted from *Weather Bureau Technical Paper No. 1* (U.S. Weather Bureau 1961) only after investigation demonstrated their applicability to data from the area covered by this Atlas.

Procedures for estimating 1-hr (60-min) precipitation-frequency values. Multiple-regression screening techniques were used to develop equations for estimating 1-hr duration values. Factors considered in the screening process were restricted to those that could be determined easily from the maps of this Atlas or from generally available topographic maps.

The 11 western states were separated into several geographic regions. The regions were chosen on the basis of meteorological and climatological homogeneity and are generally combinations of drainage basins separated by prominent divides. Two of these geographic regions are partially within New Mexico. The first region is that south of the North Platte River Drainage and east of the Continental Divide and the generalized crestline of the Sangre de Cristo Range and the Sacramento Mountains. Eastern New Mexico (Region 1, fig. 18) is part of this region. The second region is that portion of the State west of this crestline. This region extends southward through Arizona and northward to eastern Utah and northern Colorado. Equations to provide estimates for the 1-hr duration for 2- and 100-yr return periods are shown in table 11. Also shown are the statistical parameters associated with each equation. In these equations, the variable [(X₁)(X₁/X₂)] or [(X₃)(X₃/X₄)] may be regarded as the 6-hr value times the slope of the line con-

As with any separation into regions, the boundary cannot be regarded as the sharpest portion of a zone of transition between regions. These equations have been tested for boundary discontinuities by computing values using equations from both sides of the boundary. Differences were found to be mostly within 15 percent. However, it is suggested that when computing estimates along or within a few miles of a regional boundary, computations be made using equations applicable to each region and that the average of such computations be adopted.

Estimates of 1-hr precipitation-frequency values for return periods between 2 and 100 yrs. The 1-yr values for the 2- and 100-yr return periods can be plotted on the nomogram of figure 15 to obtain values for return periods greater than 2 yrs or less than 100 yrs. Draw a straight line connecting the 2- and 100-yr values and read the desired return-period value from the nomogram.

Estimates for 2- and 3-hr (120- and 180-min) precipitation frequency values. To obtain estimates of precipitation-frequency values for 2 or 3 hrs, plot the 1- and 6-hr values from the Atlas on the appropriate nomogram of figure 15. Draw a straight line connecting the 1- and 6-hr values, and read the 2- and 3-hr values from the nomogram. This nomogram is independent of return period. It was developed using data from the same regions used to develop the 1-hr equations.

The mathematical solution from the data used to develop figure 15 gives the following equations for estimating the 2- and 3-hr values:

- For Region 1, figure 18: 2-hr = 0.342 (6-hr) + 0.658 (1-hr)
- 3-hr = 0.597 (6-hr) + 0.403 (1-hr)
- For Region 2, figure 18: 2-hr = 0.341 (6-hr) + 0.659 (1-hr)
- 3-hr = 0.569 (6-hr) + 0.431 (1-hr)

Estimates for 12-hr (720-min) precipitation-frequency values. To obtain estimates for the 12-hr duration, plot values from 6- and 24-hr maps on figure 16. Read the 12-hr estimates at the intersection of the line connecting these points with the 12-hr duration line of the nomogram.

Estimates for less than 1 hr. To obtain estimates for durations of less than 1 hr, apply the values in table 12 to the 1-hr value

Illustration of Use of Precipitation-Frequency Maps, Diagrams, and Equations

To illustrate the use of these maps, values were read from figures 19 to 30 for the point at 34°00' N. and 106°00' W. These values are shown in boldface type in table 13. The values read from the maps should be plotted on the return-period diagram of figure 6 because (1) not all points are as easy to locate on a series of maps as are latitude-longitude intersections, (2) there may be some slight registration differences in printing, and (3) precise interpolation between isolines is difficult. This has been done for the 24-hr values in table 13 (fig. 17a) and a line of best fit has been drawn subjectively. In figure 17a, the data points appear to fit the line rather closely. Had there been noticeable departure from the line by any point, a new value would have been read from the nomogram and adopted in preference to the original reading.

The 2- and 100-yr 1-hr values for the point were computed from the equations applicable to western New Mexico (table 11) since the point is west of the generalized crest of the Sangre de Cristo Range and Sacramento Mountains. The 2-yr 1-hr value estimate is 0.97 in. (2-yr 6- and 24-hr values from table 13); the estimated 100-yr 1-hr value is 2.26 in. (100-yr 6- and 24-hr values from table 13). By plotting these 1-hr values on figure 6 and connecting them with a straight line, one can obtain estimates for return periods of 5, 10, 25, and 50 yrs.

The 2- and 3-hr values can be estimated by using the nomogram of figure 15 or equations (5) and (6). The 1- and 6-hr values for the desired return period are obtained as above. Plot these points on the nomogram of figure 15 and connect them with a straight line. Read the estimates for 2 or 3 hrs at the intersections of the connecting line and the 2- and 3-hr vertical lines. An example is shown in figure 17b for the 100-yr return period. The 100-yr 2-hr (2.48 in.) and 100-yr 3-hr (2.62 in.) values are in italics on table 13.

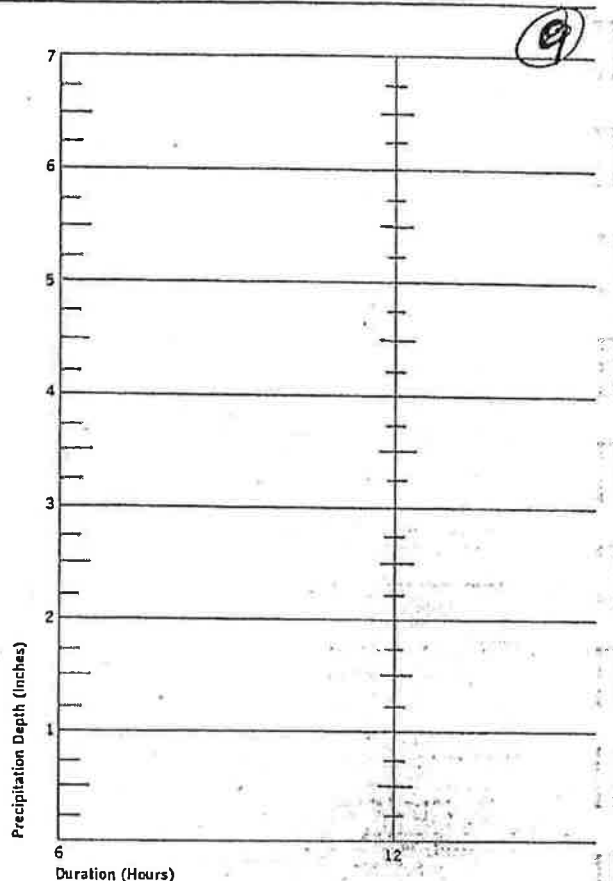

Retention Values.

Duration (min)	5	10	15	30
Ratio to 1-hr	0.29	0.45	0.57	0.79

(Adopted from U.S. Weather Bureau Technical Paper No. 40, 1961.)

	1-hr	2-hr	3-hr	6-hr
2-yr	0.97			1.27
5-yr				1.67
10-yr				1.97
25-yr				2.35
50-yr				2.61
100-yr	2.26	2.48	2.62	2.90



X = location

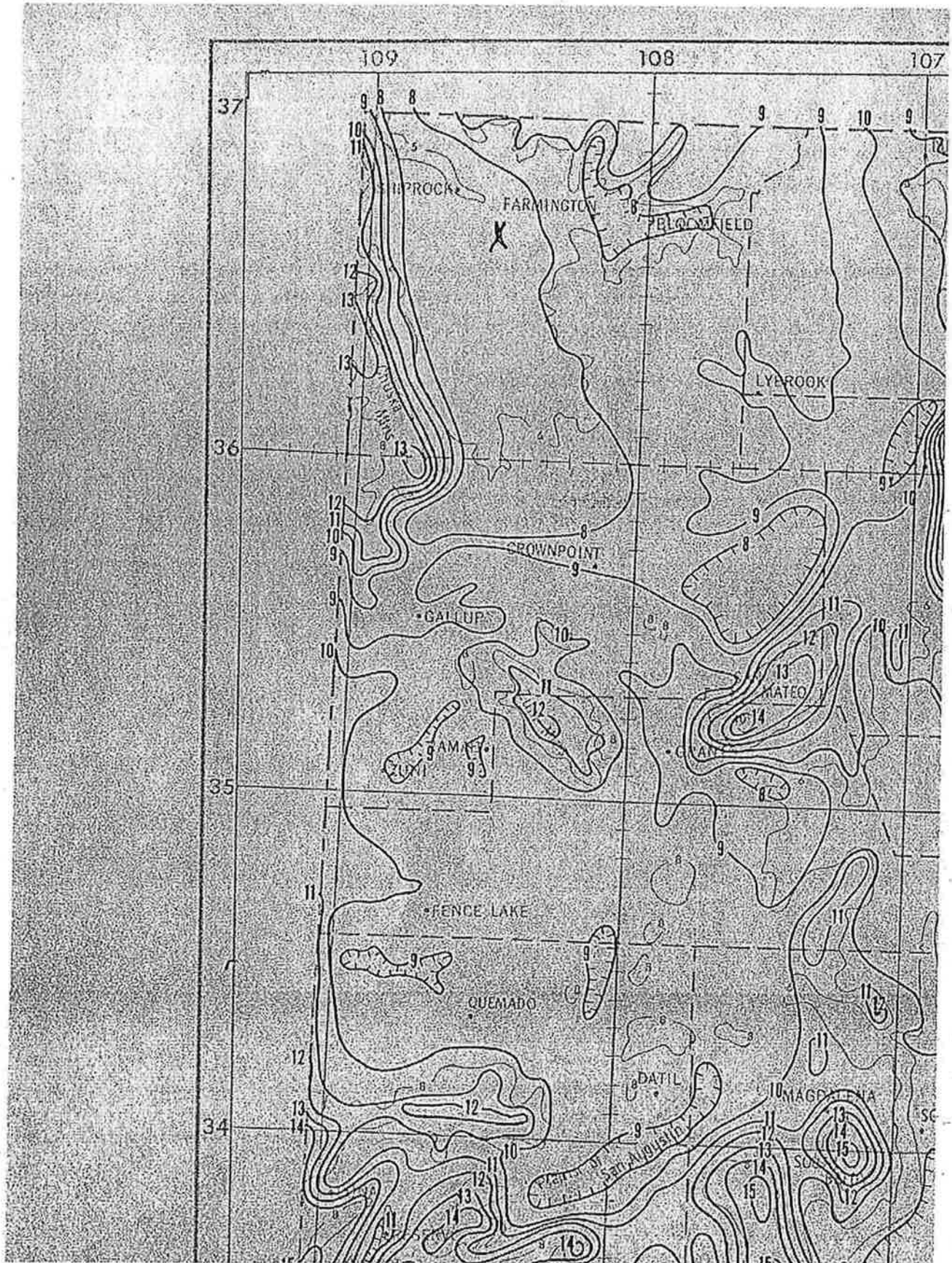

X = site location

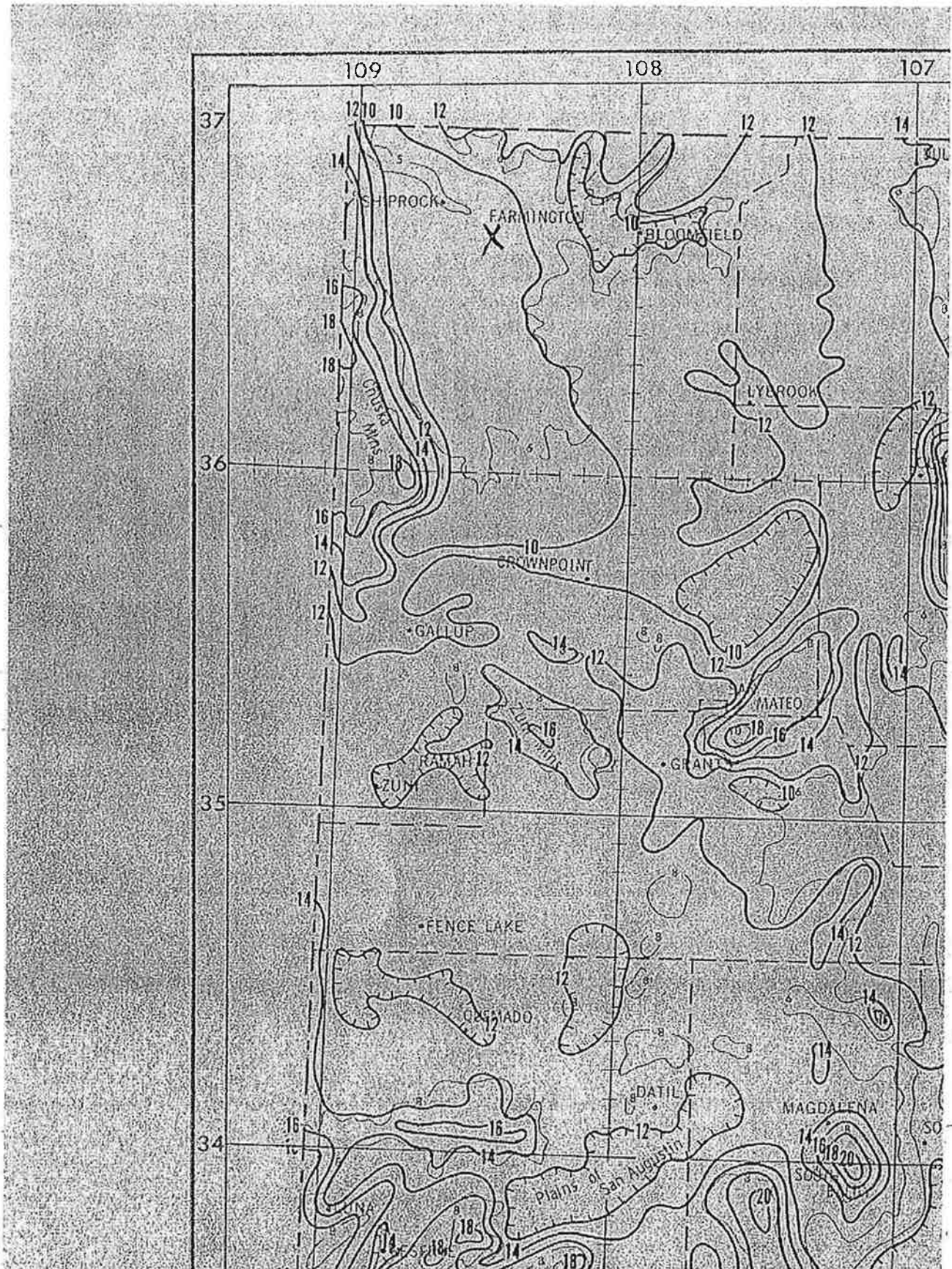



X = SITE LOCATION

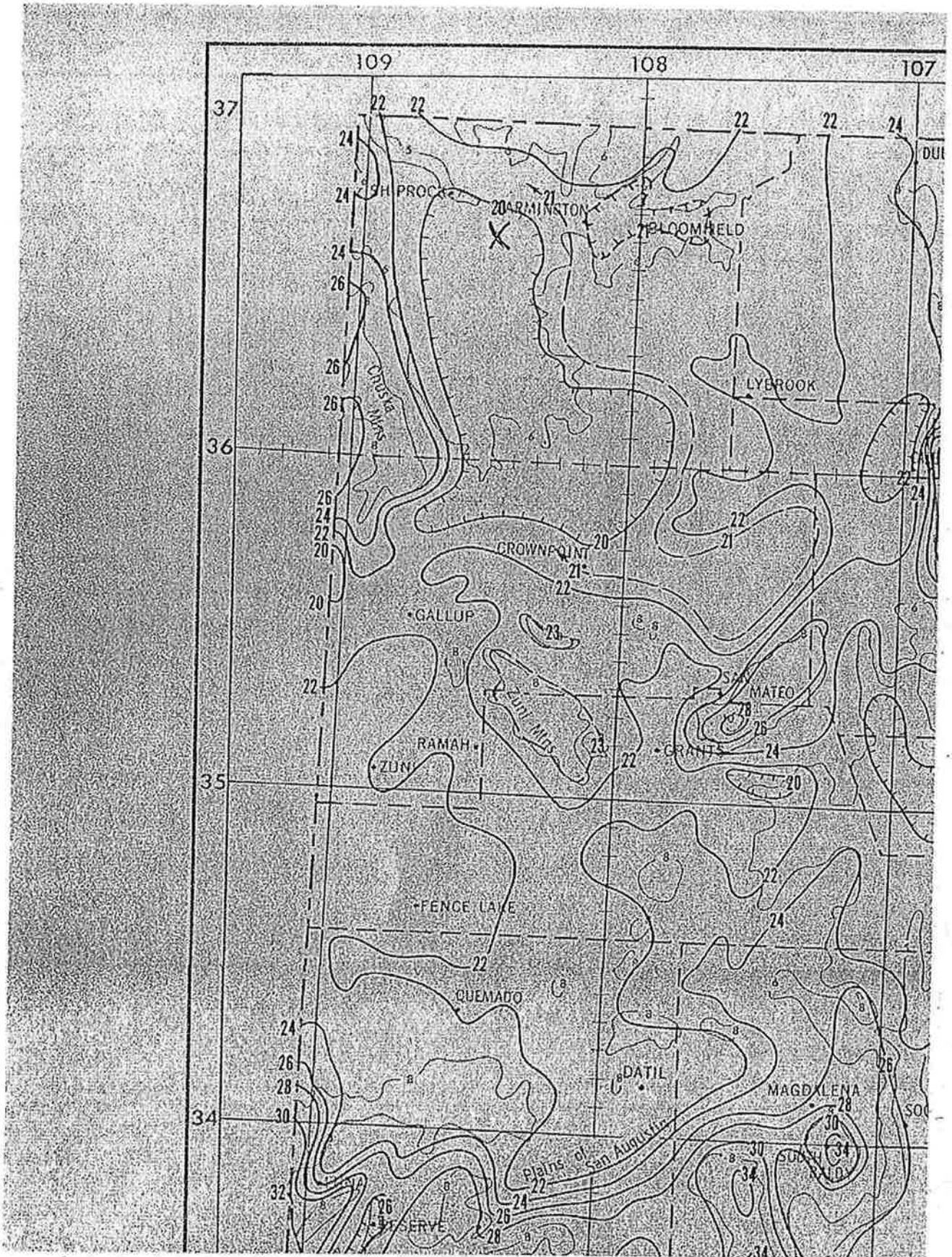

X = Site location

13

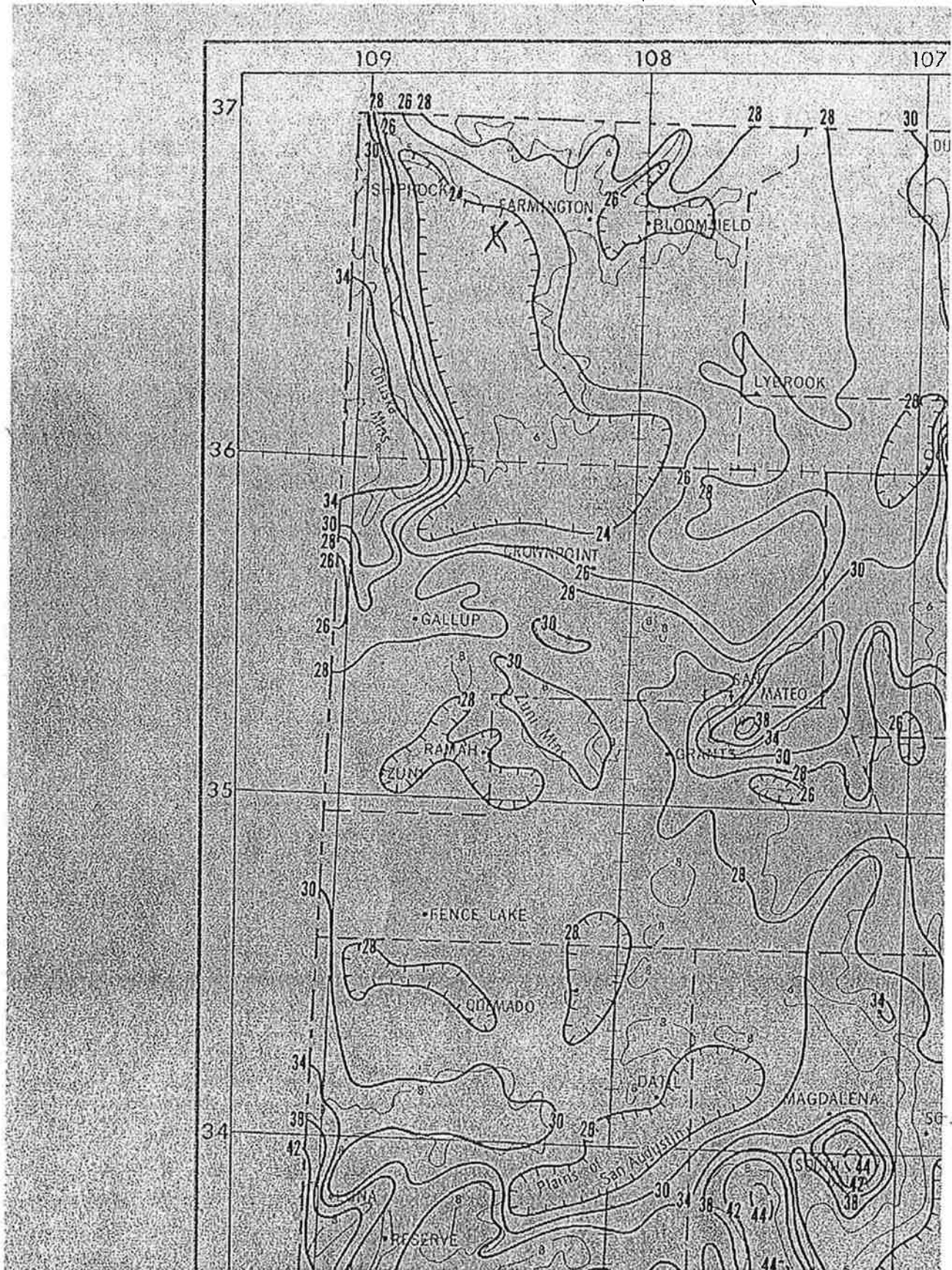

Arizona Public Service Co.
Four Corners Fly Ash Ponds

PMP Calculations

	A	B	C	D	E	F	G	H	I	J	K	L	M	N	O	P	Q	R	S	T	U	V	W	X	Y	Z
1	MONTH DEC																									
2	MONTH JAN																									
3	MONTH FEB																									
4	MONTH MAR																									
5	MONTH APR																									
6	MONTH MAY																									
7	MONTH JUN																									
8	MONTH JUL																									
9	MONTH AUG																									
10	MONTH SEP																									
11	MONTH OCT																									
12	MONTH NOV																									
13	MONTH DEC																									
14	MONTH JAN																									
15	MONTH FEB																									
16	MONTH MAR																									
17	MONTH APR																									
18	MONTH MAY																									
19	MONTH JUN																									
20	MONTH JUL																									
21	MONTH AUG																									
22	MONTH SEP																									
23	MONTH OCT																									
24	MONTH NOV																									
25	MONTH DEC																									
26	MONTH JAN																									
27	MONTH FEB																									
28	MONTH MAR																									
29	MONTH APR																									
30	MONTH MAY																									
31	MONTH JUN																									
32	MONTH JUL																									
33	MONTH AUG																									
34	MONTH SEP																									
35	MONTH OCT																									
36	MONTH NOV																									
37	MONTH DEC																									
38	MONTH JAN																									
39	MONTH FEB																									
40	MONTH MAR																									
41	MONTH APR																									

Peak occurs in the Month of August.

6 12 18 24 48 72 - lbs.

✓ TCR

Arizona Public Service Co.
Four Corners Fly Ash Ponds

PMP Calculations

	A	B	C	D	E	F	G	H	I
1	MONTH	DEC							
2	A								
3	1	8.7	in						
4	2	0.46	in						
5	3	=B3*B4							
6	4	0.6	0.81	0.92	1	1.2	1.32		
7	5	=B6*\$B\$5	=C6*\$B\$5	=D6*\$B\$5	=E6*\$B\$5	=F6*\$B\$5	=G6*\$B\$5	in	
8	6	=B7	=C7-B7	=D7-C7	=E7-D7	=F7-E7	=G7-F7	in	
9	7	1	1	1	1	1	1		
10	8	=B8*B9	=C8*C9	=D8*D9	=E8*E9	=F8*F9	=G8*G9	in	
11	9	=B10	=B11+C10	=C11+D10	=D11+E10	=E11+F10	=F11+G10	in	
12	B								
13	1	1.9	in						
14	2	1							
15	3	0.84							
16	4	=B13*B14*B15	in						
17	5	0.33	0.6	0.82	1	1.49	1.72		
18	6	=B17*\$B\$16	=C17*\$B\$16	=D17*\$B\$16	=E17*\$B\$16	=F17*\$B\$16	=G17*\$B\$16	in	
19	C								
20	1	=B11+B18	=C11+C18	=D11+D18	=E11+E18	=F11+F18	=G11+G18	in	
21									
22	MONTH	JUL							
23	A								
24	1	12	in						
25	2	0.46	in						
26	3	=B24*B25							
27	4	0.72	0.88	0.95	1	1.13	1.18		
28	5	=B27*\$B\$26	=C27*\$B\$26	=D27*\$B\$26	=E27*\$B\$26	=F27*\$B\$26	=G27*\$B\$26	in	
29	6	=B28	=C28-B28	=D28-C28	=E28-D28	=F28-E28	=G28-F28	in	
30	7	1	1	1	1	1	1		
31	8	=B29*B30	=C29*C30	=D29*D30	=E29*E30	=F29*F30	=G29*G30	in	
32	9	=B31	=B32+C31	=C32+D31	=D32+E31	=E32+F31	=F32+G31	in	
33	B								
34	1	1.9	in						
35	2	1							
36	3	0.93							
37	4	=B34*B35*B36	in						
38	5	0.33	0.6	0.82	1	1.49	1.72		
39	6	=B38*\$B\$37	=C38*\$B\$37	=D38*\$B\$37	=E38*\$B\$37	=F38*\$B\$37	=G38*\$B\$37	in	
40	C								
41	1	=B32+B39	=C32+C39	=D32+D39	=E32+E39	=F32+F39	=G32+G39	in	

pmp CALC

15

Arizona Public Service Co.
Four Corners Fly Ash Ponds

PMP Calculations

	J	K	L	M	N	O	P	Q	R
1	MONTH JAN								
2	A								
3	1	8.5	in						
4	2	0.46							
5	3	=K3*K4	in						
6	4	0.61		0.92	1	1.2	1.31		
7	5	=K6*\$K\$5	=L6*\$K\$5	=M6*\$K\$5	=N6*\$K\$5	=O6*\$K\$5	=P6*\$K\$5	in	
8	6	=K7	=L7-K7	=M7-L7	=N7-M7	=O7-N7	=P7-O7	in	
9	7	1	1	1	1	1	1		
10	8	=K8*K9	=L8*L9	=M8*M9	=N8*N9	=O8*O9	=P8*P9	in	
11	9	=K10	=L11+L10	=M11+M10	=N11+N10	=O11+O10	=P11+P10	in	
12	B								
13	1	1.9	in						
14	2	1							
15	3	0.81							
16	4	=K13*K14*K15	in						
17	5	0.33	0.6	0.82	1	1.49	1.72		
18	6	=K17*\$K\$16	=L17*\$K\$16	=M17*\$K\$16	=N17*\$K\$16	=O17*\$K\$16	=P17*\$K\$16	in	
19	C								
20	1	=K11+K18	=L11+L18	=M11+M18	=N11+N18	=O11+O18	=P11+P18	in	
21									
22	MONTH AUG								
23									
24	1	14	in						
25	2	0.46							
26	3	=K24*K25	in						
27	4	0.73	0.88	0.95	1	1.13	1.18		
28	5	=K27*\$K\$26	=L27*\$K\$26	=M27*\$K\$26	=N27*\$K\$26	=O27*\$K\$26	=P27*\$K\$26	in	
29	6	=K28	=L28-K28	=M28-L28	=N28-M28	=O28-N28	=P28-O28	in	
30	7	1	1	1	1	1	1		
31	8	=K29*K30	=L29*L30	=M29*M30	=N29*N30	=O29*O30	=P29*P30	in	
32	9	=K31	=K32+L31	=L32+M31	=M32+N31	=N32+O31	=O32+P31	in	
33	B								
34	1	1.9	in						
35	2	1							
36	3	1							
37	4	=K34*K35*K36	in						
38	5	0.33	0.6	0.82	1	1.49	1.72		
39	6	=K38*\$K\$37	=L38*\$K\$37	=M38*\$K\$37	=N38*\$K\$37	=O38*\$K\$37	=P38*\$K\$37	in	
40	C								
41	1	=K32+K39	=L32+L39	=M32+M39	=N32+N39	=O32+O39	=P32+P39	in	

Steps in figures detail on
FD - of this Calculation
Package

Table 2.7 after figure 2.26
Multiply by ratios
Subtraction of values successively
100%

Table 3.9

(B)

from Values

from fig 2.12
fig 2.18

from fig 3.11c
100%
100% from fig 3.15

pmp CALC

Arizona Public Service Co.
Four Corners Fly Ash Ponds

PMP Calculations

	S	T	U	V	W	X	Y	Z
1	MONTH FEB							
2	A							
3	1	8.6	in					
4	2	0.46						
5	3	=T3*T4	in					
6	4	0.6	0.81	0.92	1	1.2	1.32	
7	5	=T6*\$T\$5	=U6*\$T\$5	=V6*\$T\$5	=W6*\$T\$5	=X6*\$T\$5	=Y6*\$T\$5	in
8	6	=T7	=U7-T7	=V7-U7	=W7-V7	=X7-W7	=Y7-X7	in
9	7	1	1	1	1	1	1	
10	8	=T8*T9	=U8*U9	=V8*V9	=W8*W9	=X8*X9	=Y8*Y9	in
11	9	=T10	=T11+U10	=V11+V10	=W11+W10	=X11+X10	=Y11+Y10	in
12	B							
13	1	1.9	in					
14	2	1						
15	3	0.8						
16	4	=T13*T14*T15	in					
17	5	0.33	0.6	0.82	.1	1.49	1.72	
18	6	=T17*\$T\$16	=U17*\$T\$16	=V17*\$T\$16	=W17*\$T\$16	=X17*\$T\$16	=Y17*\$T\$16	in
19	C							
20	1	=T11+T18	=U11+U18	=V11+V18	=W11+W18	=X11+X18	=Y11+Y18	in
21								
22	MONTH SEP							
23	A							
24	1	13.7	in					
25	2	0.46						
26	3	=T24*T25	in					
27	4	0.72	0.88	0.95	1	1.13	1.18	
28	5	=T27*\$T\$26	=U27*\$T\$26	=V27*\$T\$26	=W27*\$T\$26	=X27*\$T\$26	=Y27*\$T\$26	in
29	6	=T28	=U28-T28	=V28-U28	=W28-V28	=X28-W28	=Y28-X28	in
30	7	1	1	1	1	1	1	
31	8	=T29*T30	=U29*U30	=V29*V30	=W29*W30	=X29*X30	=Y29*Y30	in
32	9	=T31	=T32+U31	=V32+V31	=W32+W31	=X32+X31	=Y32+Y31	in
33	B							
34	1	1.9	in					
35	2	1						
36	3	1						
37	4	=T34*T35*T36	in					
38	5	0.33	0.6	0.82	1	1.49	1.72	
39	6	=T38*\$K\$37	=U38*\$K\$37	=V38*\$K\$37	=W38*\$K\$37	=X38*\$K\$37	=Y38*\$K\$37	in
40	C							
41	1	=T32+T39	=U32+U39	=V32+V39	=W32+W39	=X32+X39	=Y32+Y39	in

pmp CALC

17

HYDROMETEOROLOGICAL REPORT NO. 49

~~XXXXXXXXXX~~
~~XXXXXXXXXX~~
Gorman

Probable Maximum Precipitation Estimates,
Colorado River and Great Basin Drainages

REPRINTED 1984

U.S. DEPARTMENT OF COMMERCE
NATIONAL OCEANIC AND ATMOSPHERIC ADMINISTRATION
U.S. DEPARTMENT OF ARMY
CORPS OF ENGINEERS

Silver Spring, Md.

(19)

U.S. DEPARTMENT OF COMMERCE
NATIONAL OCEANIC AND ATMOSPHERIC ADMINISTRATION

U.S. DEPARTMENT OF THE ARMY
CORPS OF ENGINEERS

HYDROMETEOROLOGICAL REPORT NO. 49

Probable Maximum Precipitation Estimates,
Colorado River and Great Basin Drainages

REPRINTED 1984

Prepared by
E. Marshall Hansen,
Francis K. Schwarz, and John T. Riedel
Hydrometeorological Branch
Office of Hydrology
National Weather Service

Silver Spring, Md.

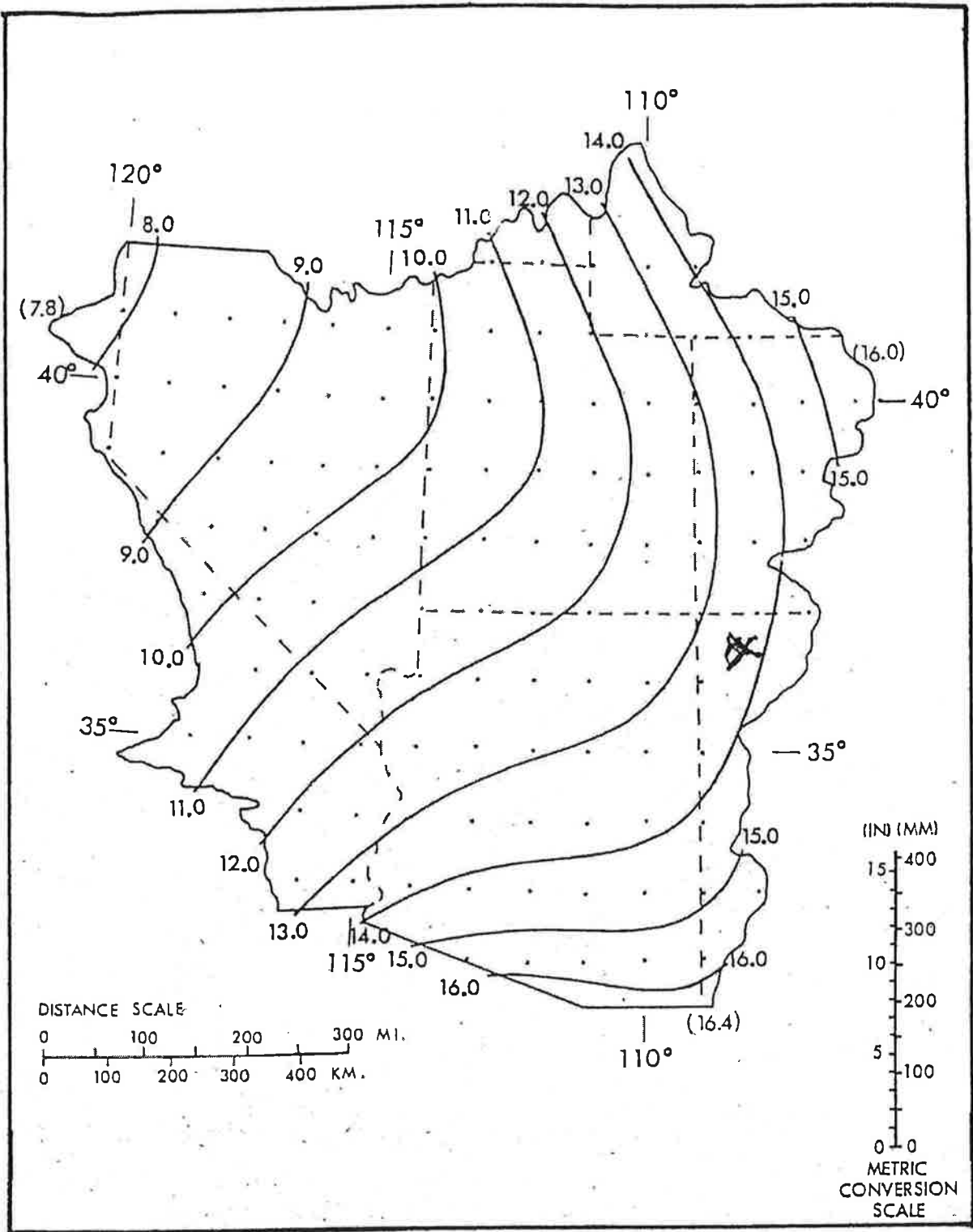

Figure 2.12.--1000-mb (100-kPa) 24-hr convergence FMP (inches) for 10 mi² (26 km²) for August. Values in parentheses are limiting values and are to facilitate extrapolation beyond the indicated gradient.

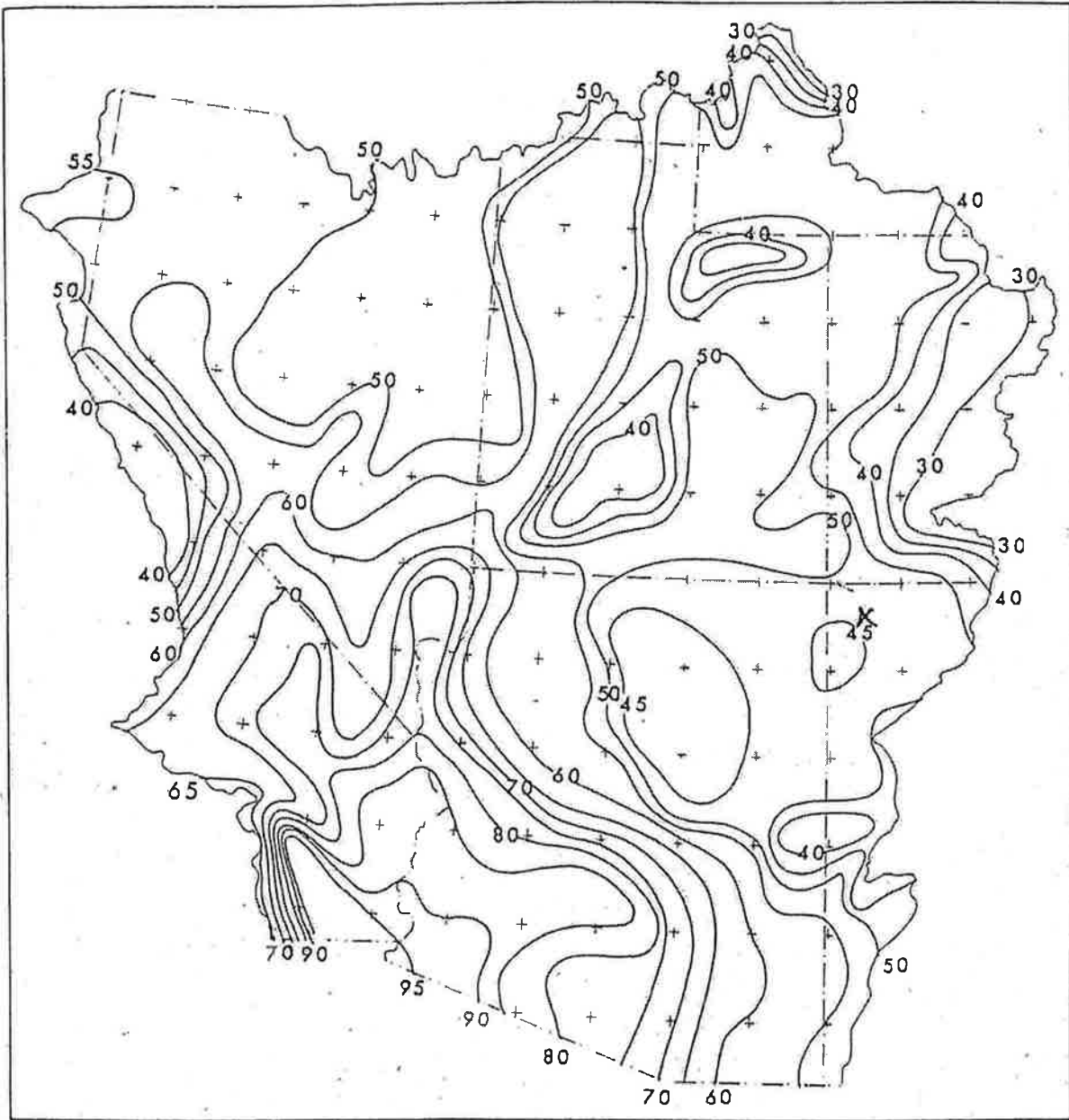
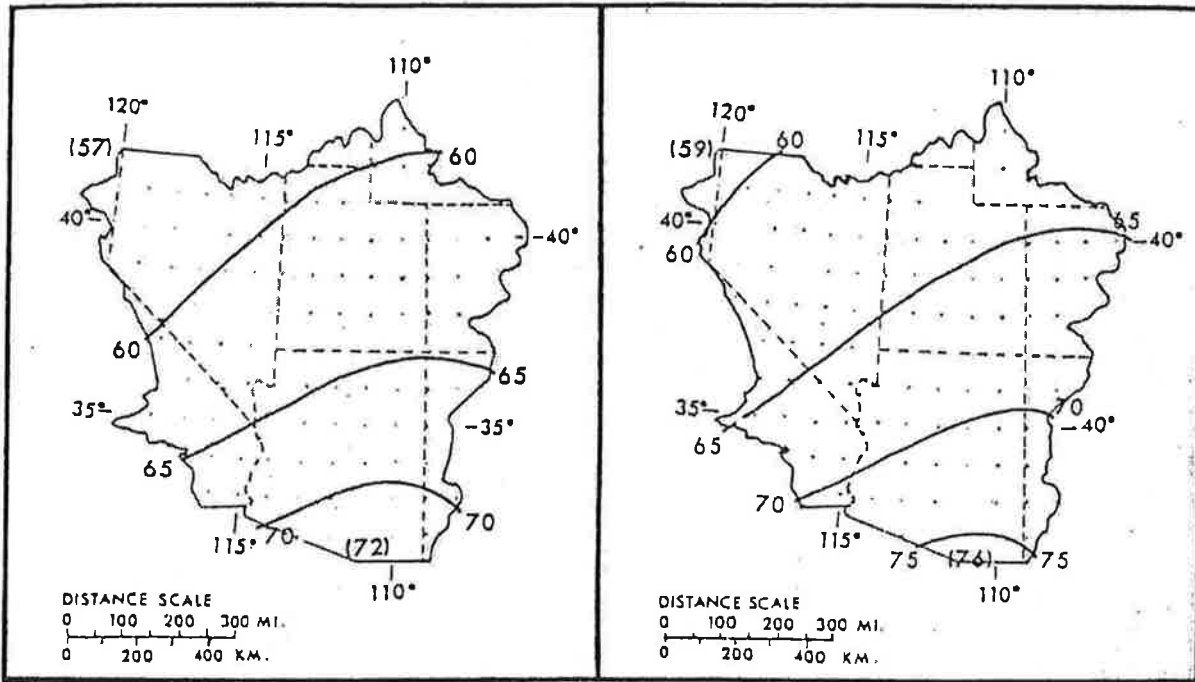
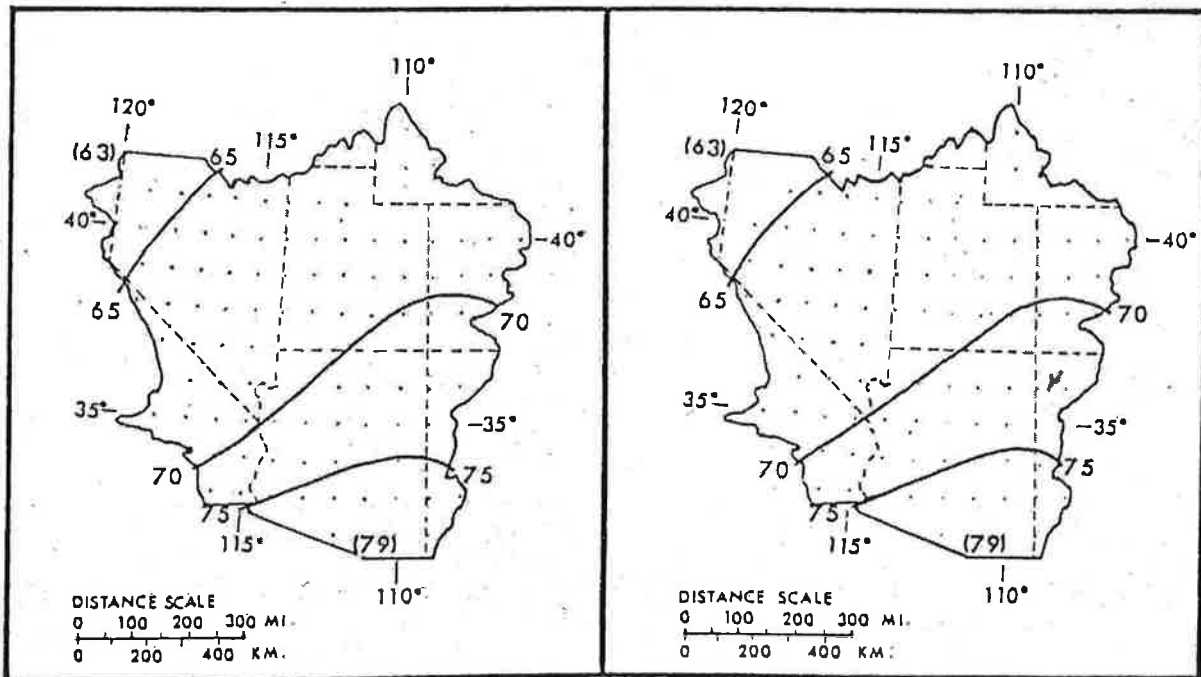

Figure 2.18.--Percent of 1000-mb (100-kPa) convergence PMP resulting from effective elevation and barrier considerations. Isolines drawn for every five percent.



May

June



July

August

Figure 2.26.--Regional variation of 6/24-hr ratios by month (percent). Values in parentheses are limiting values and are to facilitate extrapolation beyond the indicated gradient.

For the range of 6/24-hr ratios included in figures 2.25 to 2.27, depth-duration values in percent of 24-hr amounts are found in table 2.7. The regional ratio maps, and the depth-duration curves presented in figure 2.20 were used in adjusting the major storm data to 24-hr amounts listed in table 2.1.

Table 2.7.--Durational variation of convergence PMP (in percent of 24-hr amount).

Duration (Hrs)						Duration (Hrs)					
6	12	18	24	48	72	6	12	18	24	48	72
50	76	90	100	129	150	66	84	93	100	116	124
51	77	90	100	128	148	67	85	94	100	116	123
52	77	90	100	127	146	68	85	94	100	115	122
53	77	91	100	127	144	69	86	94	100	115	121
54	78	91	100	126	142						
55	78	91	100	125	140	70	87	94	100	114	120
56	79	91	100	124	138	71	87	95	100	114	119
57	79	92	100	123	137	72	88	95	100	113	118
58	80	92	100	122	135	73	88	95	100	113	118
59	80	92	100	121	134	74	89	95	100	112	117
						75	89	96	100	112	116
60	81	92	100	120	132	76	90	96	100	111	115
61	81	92	100	120	131	77	90	96	100	110	114
62	82	93	100	119	129	78	91	96	100	110	114
63	82	93	100	118	128	79	92	97	100	109	113
64	83	93	100	117	126						
65	84	93	100	117	125	80	92	97	100	109	113

Aug

Note: For use, enter first column (6 hr) with 6/24-hr ratio from figures 2.25 to 2.27.

2.5 Areal Reduction for Basin Size

For operational use, basin average values of convergence PMP are needed rather than 10-mi² (26-km²) values. Preferably, the method for reducing 10-mi² (26-km²) values to basin average rainfalls should be derived from depth-area relations of storms in the region. However, all general storms in the region include large proportions of orographic precipitation.

Our solution was to use generalized depth-area relations developed for PMP estimates within bordering zones in the Central and Eastern United States (Riedel et al. 1956). The smoothed areal variations adopted for the Southwestern States are shown in figures 2.28 and 2.29 for each month or a combination of months where differences are insignificant.

Figures 2.28 and 2.29 give depth-area relations that reduce 10-mi² (26-km²) convergence PMP for basin sizes up to 5,000 mi² (12,950 km²) for each month. Areal variations are given for the 4 greatest (1st to 4th) 6-hr PMP increments. After the 4th increment no reduction for basin size is required. Application of these figures will become clear through consideration of an example of PMP computation in chapter 6.

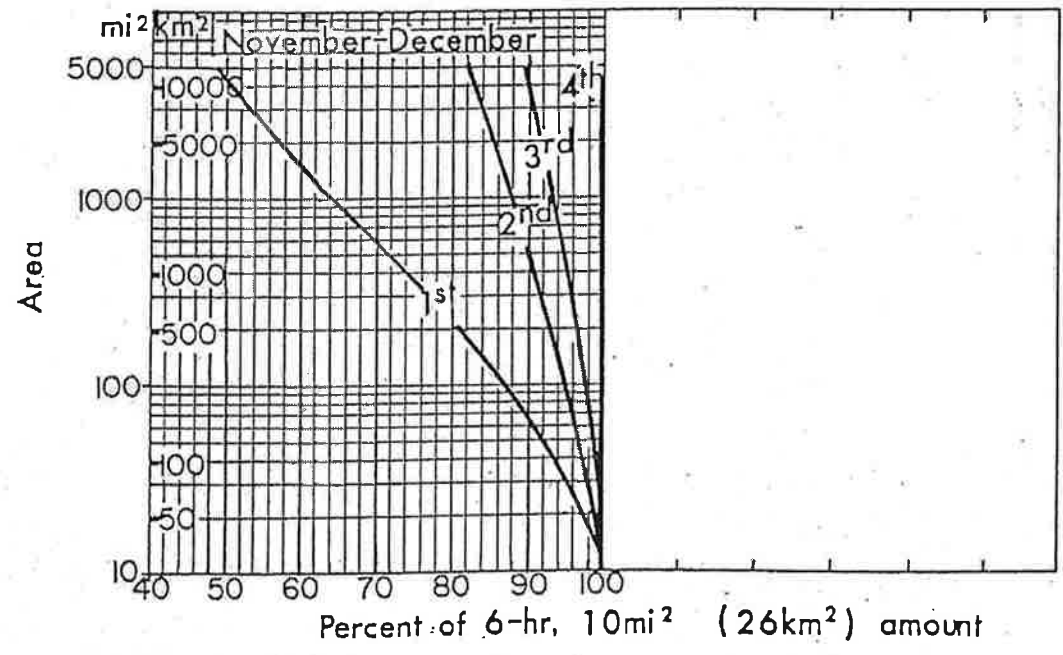
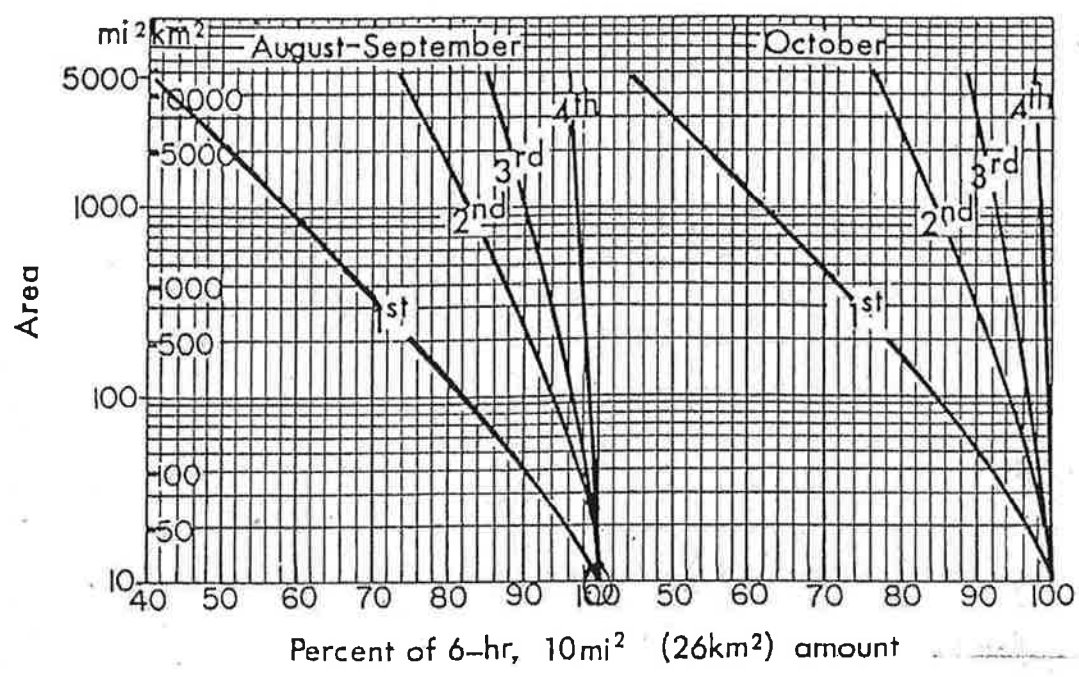

Figure 2.29.--Depth-area variation for convergence PMP for first to fourth 6-hr increments.

25

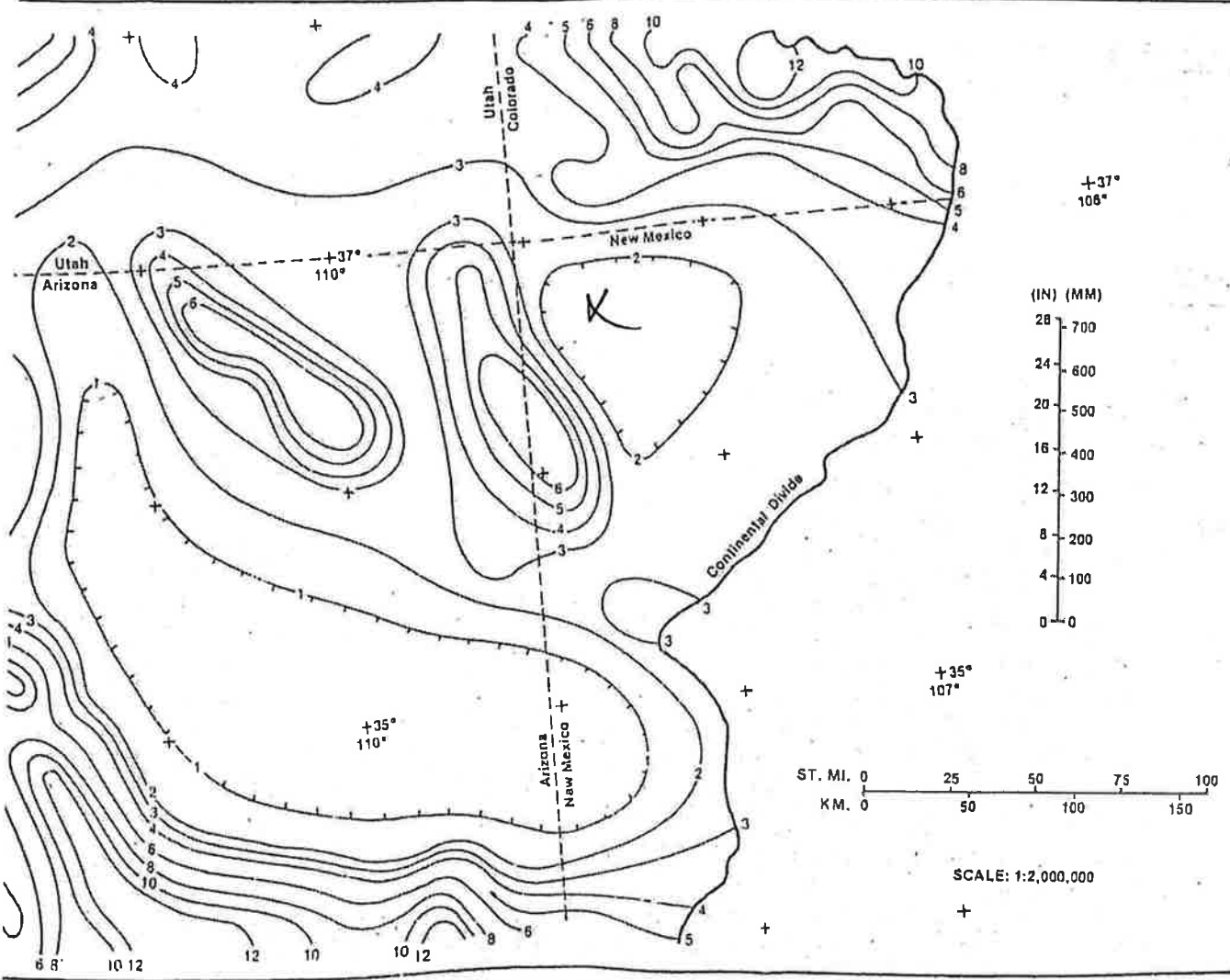
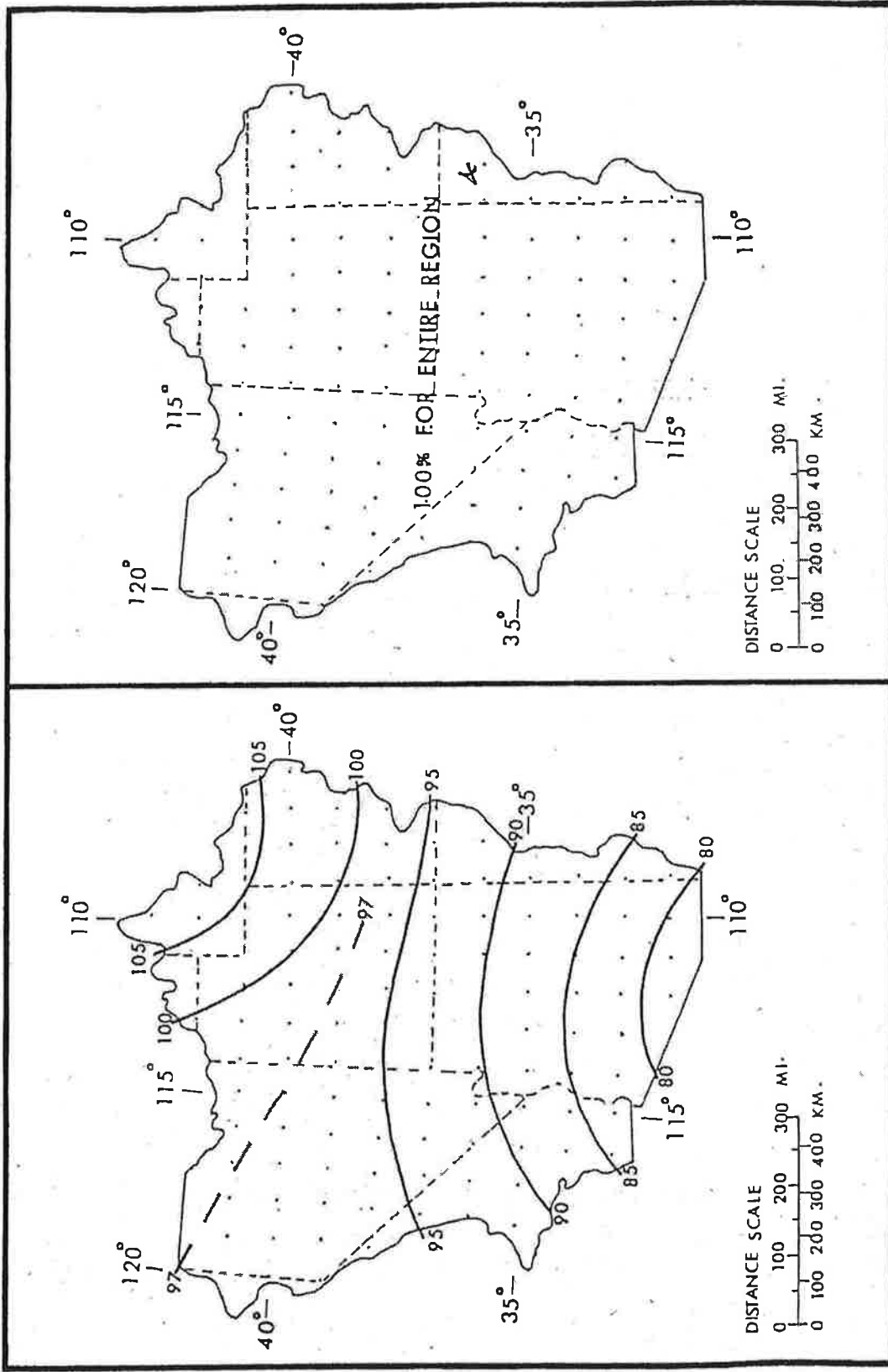

FIGURE 3.11c (Revised) -- 10-mi² (25-km²) 24-hr orographic PMP index map (inches), south-central section.



July

August

Figure 3.15.--Seasonal variation in 10-mi² (26-km²) 24-hr orographic PMP for the study region (in percent of values in figure 3.11).

20

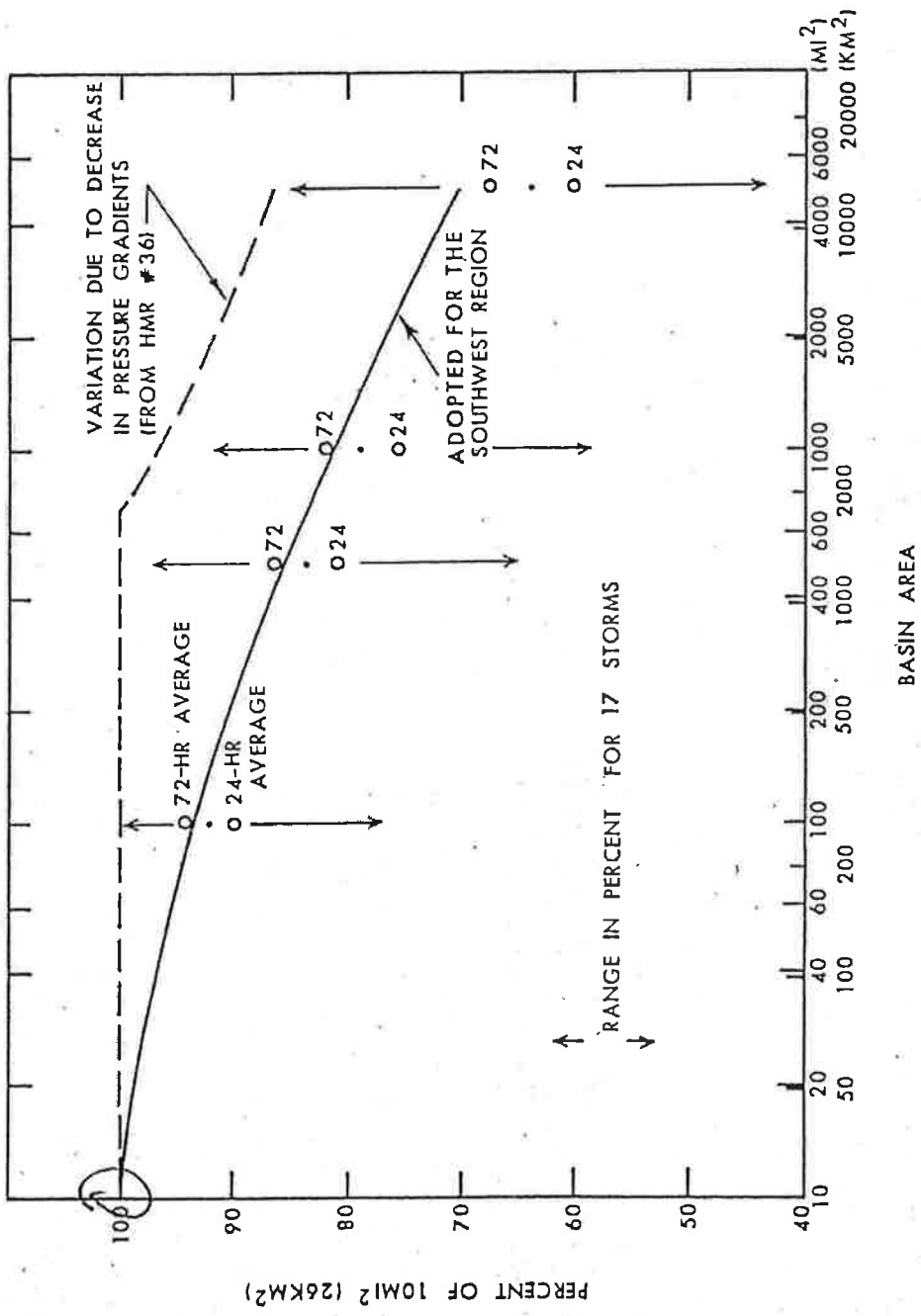

Figure 3.20. --Variation of orographic PMP with basin size.

Table 3.9.--Durational variation of orographic PMP

Latitude °N	Percent of 24-hr value					
	6 hr	12	18	24	48	72
42	28	55	79	100	161	190
41	29	56	79	100	160	189
40	30	57	80	100	159	187
39	30	57	80	100	157	185
38	31	58	81	100	155	182
37	32	59	81	100	152	177
→ 36	33	60	82	100	149	172 ←
35	34	61	82	100	146	167
34	35	62	83	100	143	162
33	36	63	84	100	139	157
32	37	64	84	100	135	152
31	39	66	85	100	132	146

4. LOCAL-STORM PMP FOR THE SOUTHWESTERN REGION AND CALIFORNIA

4.1 Introduction

This chapter provides generalized estimates of local or thunderstorm probable maximum precipitation. By "generalized" is meant that mapped values are given from which estimates of PMP may be determined for any selected drainage.

4.1.1 Region of Interest

Local-storm PMP was not included in the "Interim Report, Probable Maximum Precipitation in California" (HMR No. 36). During the formulation of the present study, we decided that the local-storm part of the study should include California west of the Sierra Nevada. It was also noted that PMP for summer thunderstorms was not considered west of the Cascade Divide in the Northwestern Region (HMR No. 43). As stated in the latter report, "No summer thunderstorms have been reported there (west of the Divide) of an intensity of those to the east, for which the moisture source is often the Gulf of Mexico or Gulf of California. The Cascade Divide offers an additional barrier to such moisture inflows to coastal areas where, in addition, the Pacific Ocean to the west has a stabilizing influence on the air to hinder the occurrence of intense summer local storms." Therefore, it was necessary to establish some continuation of the Cascade Divide into California so that the local-storm PMP definition would have continuity between the two regions.

The stabilizing influence of the Pacific air is at times interrupted by the warm moist tropical air from the south pushing into California, although it is difficult to determine where the limit of southerly flow occurs. General storms having the tropical characteristic of excessive thunderstorm rains are observed as far north as the northern end of the Sacramento Valley. Thus, a northern boundary has been selected for this study, excluding that portion of

281

6. PROCEDURES FOR COMPUTING PMP

6.1 Introduction

For estimating general-storm PMP for a specific drainage the maps, charts, and tables required are in chapters 2 and 3. A stepwise procedure for using these materials is given here with a computation form, table 6.1. This is followed by an example of the computations for a selected drainage (table 6.2).

The stepwise procedure and computation form are set up to give general-storm PMP for a given month. If the highest value over all months (called the "all-season" PMP) is needed, it may be necessary to compute PMP for several months and to then select the highest value.

The local-storm PMP for small drainages described in chapter 4 should be compared with general-storm PMP for any drainage and the most critical values selected. Depending on hydrologic characteristics of a particular drainage, its location, size, and the problem at hand, a 500-mi² (1,295-km²) local storm, well placed on a drainage larger than 500 mi², may be the more critical of the two storm types. A step-wise procedure is given (sec. 6.3) for computing local-storm PMP. Part A gives the drainage average PMP while part B gives the areal distribution of PMP over the drainage. A computation form is provided in table 6.3, for computing these estimates. Table 6.4 is an example of these computations.

Local-storm PMP also covers the Pacific drainage of California. General-storm PMP for this region is given in HMR No. 36, with revisions (U.S. Weather Bureau 1969).

The procedures have been developed to give PMP in tenths of inches. Although in some instances it may be possible to discriminate values from figures and tables to hundredths of an inch or fractions of a percent, PMP estimates should be rounded to the nearest tenth of an inch.

6.2 Steps for Computing General-Storm PMP for a Drainage

A. Convergence PMP. The steps correspond to those in table 6.1.

1. Obtain drainage average 1000-mb (100-kPa) 24-hr 10-mi² (26-km²) convergence PMP for month of interest from one of figures 2.5 to 2.16.

2. Obtain the 1000-mb (100-kPa) 24-hr 10-mi² (26-km²) convergence PMP reduction factor for effective barrier and elevation in percent from figure 2.18.

3. Step 1 value times step 2 value gives barrier-elevation reduced 24-hr 10-mi² (26-km²) convergence PMP average for the drainage.

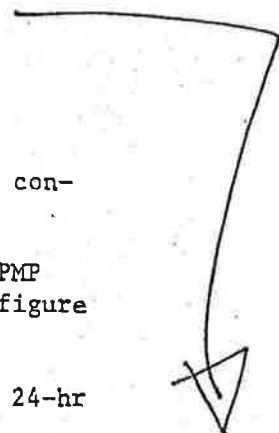

4. Determine drainage 6/24-hr ratio for month of interest from figures 2.25 and 2.27. Enter table 2.7 with this ratio to obtain 6-, 12-, 18-, 24-, 48-, and 72-hr values in % of the 24-hr value.

5. Step 3 value times percents from step 4 provides convergence PMP for durations of step 4 for 10 mi² (26 km²).

6. Incremental 10-mi² (26-km²) convergence PMP is obtained by successive subtraction of values in step 5.

7. Areal reduction in percent for drainage area is obtained from figure 2.28 or 2.29 for the month of interest.

8. Values from step 6 times corresponding percents from step 7 are the areally reduced incremental convergence PMP in inches (mm).

9. Accumulation of incremental values from step 8 gives drainage average convergence component PMP for 6, 12, 18, 24, 48 and 72 hours.

B. Orographic PMP

1. Drainage average orographic PMP index for 24 hours 10 mi² (26 km²) is read from one of figures 3.11a to d (foldout pages).

2. Areal reduction factor in percent for drainage size is read from figure 3.20.

3. To get seasonal adjustment, locate drainage on map for month of interest, figures 3.12 to 3.17, and read average percent for the drainage.

4. Areal and seasonally adjusted 24-hr orographic PMP in inches (mm) is obtained by multiplying values from step 1 by percents from steps 2 and 3.

5. Durational variation of orographic PMP in percent of the 24-hr value for 6, 12, 18, 24, 48, and 72 hours is read from table 3.9, which is entered with the latitude of the drainage (to the nearest 1°).

6. Orographic PMP in inches (mm) for listed durations results from multiplication of values in step 4 by corresponding values in step 5.

C. Total PMP

1. Add corresponding convergence and orographic PMP values in steps A9 and B6.

2. If PMP values are required for intermediate durations, plot a smooth curve and interpolate.

3. Compare with the local-storm PMP.

Table 6.2 shows an example of the computation of general-storm PMP for the month of October for the Humboldt River drainage above Devil's Gate damsite in Nevada. The table is self-explanatory.

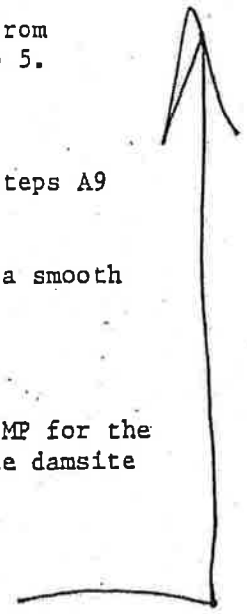

Table 6.1.--General-storm PMP computations for the Colorado River and Great basin

Drainage _____ Area _____ mi² (km²)
 Latitude _____, Longitude _____ of basin center
 Month _____

Step	Duration (hrs)				
	6	12	18	24	48

A. Convergence PMP

1. Drainage average value from one of figures 2.5 to 2.16 _____ in. (mm)
2. Reduction for barrier-elevation [fig. 2.18] _____ %
3. Barrier-elevation reduced PMP [step 1 X step 2] _____ in. (mm)
4. Durational variation [figs. 2.25 to 2.27 and table 2.7]. _____ %
5. Convergence PMP for indicated durations [steps 3 X 4] _____ in. (mm)
6. Incremental 10 mi² (26 km²) PMP [successive subtraction in step 5] _____ in. (mm)
7. Areal reduction [select from figs. 2.28 and 2.29] _____ %
8. Areal reduced PMP [step 6 X step 7] _____ in. (mm)
9. Drainage average PMP [accumulated values of step 8] _____ in. (mm)

B. Orographic PMP

1. Drainage average orographic index from figure 3.11a to d. _____ in. (mm)
2. Areal reduction [figure 3.20] _____ %
3. Adjustment for month [one of figs. 3.12 to 3.17] _____ %
4. Areally and seasonally adjusted PMP [steps 1 X 2 X 3] _____ in. (mm)
5. Durational variation [table 3.A] _____ %
6. Orographic PMP for given durations [steps 4 X 5] _____ in. (mm)

C. Total PMP

1. Add steps A9 and B6 _____ in. (mm)
2. PMP for other durations from smooth curve fitted to plot of computed data.
3. Comparison with local-storm PMP (see sec. 6.3).

GENERAL FORM
 CONVERTED TO EXCEL SPREADSHEET

APS
Fly Ash Ponds
72-Hr. PMP Calculation Worksheet

1	2	3	4	5	6	7	8	9	10	11	conv.		
n	time (duration) (hrs)	cumulative depth (inches)	incremental depth (inches)	hyetograph time period (hours)	rearranged n	incremental depth (inches)	cumulative depth (inches)	percent of total (%)	72-hr cumulative depth (inches)	72-hr increment al depth (inches)	72-hr hyetograph time period (hours)	steps	increment al depth (inches)
0	0	0	0	0.0-1.0	19	0.03	0.03	1.4%	0.15	0.15	0.0-3.0	4	0.038
1	0.25	1.00	1.00	1.0-2.0	17	0.03	0.07	2.8%	0.30	0.15	3.0-6.0	4	0.038
2	0.50	1.25	0.25	2.0-3.0	15	0.03	0.10	4.2%	0.45	0.15	6.0-9.0	4	0.038
3	0.75	1.50	0.25	3.0-4.0	13	0.03	0.13	5.3%	0.58	0.12	6.0-12.0	8	0.016
4	1.00	1.75	0.25	4.0-4.5	11	0.03	0.16	6.5%	0.70	0.12	12.0-13.5	2	0.062
5	1.25	1.77	0.02	4.5-5.0	9	0.02	0.18	7.5%	0.82	0.11	13.5-15.0	2	0.057
6	1.50	1.80	0.02	5.0-5.25	7	0.02	0.20	8.4%	0.92	0.10	15.0-15.75	1	0.102
7	1.75	1.82	0.02	5.25-5.50	5	0.02	0.23	9.4%	1.02	0.10	15.75-16.50	1	0.102
8	2.00	1.84	0.02	5.50-5.75	3	0.25	0.48	19.8%	2.16	1.14	16.50-17.25	1	1.135
9	2.50	1.87	0.02	5.75-6.0	1	1.00	1.48	61.5%	6.70	4.54	17.25-18.0	1	4.542
10	3.00	1.89	0.02	6.0-6.25	2	0.25	1.73	71.9%	7.83	1.14	18.0-18.75	1	1.135
11	3.50	1.92	0.03	6.25-6.50	4	0.25	1.98	82.3%	8.97	1.14	18.75-19.50	1	1.135
12	4.00	1.95	0.03	6.50-6.75	6	0.02	2.00	88.2%	9.07	0.10	19.50-20.25	1	0.102
13	5.00	1.97	0.03	6.75-7.0	8	0.02	2.02	84.2%	9.17	0.10	20.25-21.0	1	0.102
14	6.00	2.00	0.03	7.0-7.5	10	0.02	2.05	85.2%	9.29	0.11	21.0-22.5	2	0.057
15	7.00	2.03	0.03	7.5-8.0	12	0.03	2.07	86.4%	9.41	0.12	22.5-24.0	2	0.062
16	8.00	2.07	0.03	8.0-9.0	14	0.03	2.10	87.5%	9.54	0.12	24.0-27.0	4	0.031
17	9.00	2.10	0.03	9.0-10.0	16	0.03	2.13	88.9%	9.69	0.15	27.0-30.0	4	0.038
18	10.00	2.13	0.03	10.0-11.0	18	0.03	2.17	90.3%	9.84	0.15	30.0-33.0	4	0.038
19	11.00	2.17	0.03	11.0-12.0	20	0.03	2.20	91.7%	9.99	0.15	33.0-36.0	4	0.038
20	12.00	2.20	0.03	12.0-14.0	21	0.03	2.23	93.1%	10.14	0.15	36.0-42.0	8	0.019
21	14.00	2.23	0.03	14.0-16.0	22	0.03	2.27	94.4%	10.29	0.15	42.0-48.0	8	0.019
22	16.00	2.27	0.03	16.0-18.0	23	0.03	2.30	95.8%	10.45	0.15	48.0-54.0	8	0.019
23	18.00	2.30	0.03	18.0-20.0	24	0.03	2.33	97.2%	10.60	0.15	54.0-60.0	8	0.019
24	20.00	2.33	0.03	20.0-22.0	25	0.03	2.37	98.6%	10.75	0.15	60.0-66.0	8	0.019
25	22.00	2.37	0.03	22.0-24.0	26	0.03	2.40	100.0%	10.90	0.15	66.0-72.0	8	0.019
26	24.00	2.40	0.03										

32

APS
Fly Ash Ponds
72-Hr. PMP Calculation Worksheet

	A	B	C	D	E	F	G	H	I	J	K	L	M	N	O	P
1	n	time (duration) (hrs)	cumulative depth (inches)	incremental depth (inches)	hyetograph time period (hours)	rearranged n	incremental depth (inches)	cumulative depth (inches)	percent of total (%)	72-hr cumulative depth (inches)	72-hr incremental depth (inches)	72-hr hyetograph time period (hours)	steps	72-hr conv. incremental depth (inches)		
2	0	0	0	=C4-C3	0.0-1.0	19	=D22	=H3	=I3/\$I\$28	=J1*10.9	=L3	0.0-3.0	4	=M3/O3		
3	1	=B3+0.25	=1+0.75/3	=C5-C4	1.0-2.0	17	=D20	=H4+H3	=I4/\$I\$28	=J4*10.9	=L4-L3	3.0-6.0	4	=M4/O4		
4	2	=B4+0.25	=1+0.75/3	=C5-C4	2.0-3.0	15	=D18	=H5+H4	=I5/\$I\$28	=J5*10.9	=L5-L4	6.0-9.0	4	=M5/O5		
5	3	=B5+0.25	=1+0.75/3	=C6-C5	3.0-4.0	13	=D16	=H6+H5	=I6/\$I\$28	=J6*10.9	=L6-L5	6.0-12.0	8	=M6/O6		
6	4	=B6+0.25	1.75	=C7-C6	4.0-4.5	11	=D14	=H7+H6	=I7/\$I\$28	=J7*10.9	=L7-L6	12.0-13.5	2	=M7/O7		
7	5	=B7+0.25	=C7+(C11-C7)/4	=C8-C7	4.5-5.0	9	=D12	=H8+H7	=I8/\$I\$28	=J8*10.9	=L8-L7	13.5-15.0	2	=M8/O8		
8	6	=B8+0.25	=C7+(C11-C7)/4	=C9-C8	5.0-5.25	7	=D10	=H9+H8	=I9/\$I\$28	=J9*10.9	=L9-L8	15.0-15.75	1	=M9/O9		
9	7	=B9+0.25	=C7+(C11-C7)/4	=C10-C9	5.25-5.50	5	=D8	=H10+H9	=I10/\$I\$28	=J10*10.9	=L10-L9	15.75-16.50	1	=M10/O10		
10	8	=B10+0.25	1.84	=C11-C10	5.50-5.75	3	=D6	=H11+H10	=I11/\$I\$28	=J11*10.9	=L11-L10	16.50-17.25	1	=M11/O11		
11	9	2.5	=(C11+C13)/2	=C12-C11	5.75-6.0	1	=D4	=H12+H11	=I12/\$I\$28	=J12*10.9	=L12-L11	17.25-18.0	1	=M12/O12		
12	10	3	1.89	=C13-C12	6.0-6.25	2	=D5	=H13+H12	=I13/\$I\$28	=J13*10.9	=L13-L12	18.0-18.75	1	=M13/O13		
13	11	3.5	=C13+(C17-C13)/4	=C14-C13	6.25-6.50	4	=D7	=H14+H13	=I14/\$I\$28	=J14*10.9	=L14-L13	18.75-19.50	1	=M14/O14		
14	12	4	=C13+(C17-C13)/4	=C15-C14	6.50-6.75	6	=D9	=H15+H14	=I15/\$I\$28	=J15*10.9	=L15-L14	19.50-20.25	1	=M15/O15		
15	13	5	=C13+(C17-C13)/4	=C16-C15	6.75-7.0	8	=D11	=H16+H15	=I16/\$I\$28	=J16*10.9	=L16-L15	20.25-21.0	1	=M16/O16		
16	14	6	2	=C17-C16	7.0-7.5	10	=D13	=H17+H16	=I17/\$I\$28	=J17*10.9	=L17-L16	21.0-22.5	2	=M17/O17		
17	15	7	=C17+(C23-C17)/16	=C18-C17	7.5-8.0	12	=D15	=H18+H17	=I18/\$I\$28	=J18*10.9	=L18-L17	22.5-24.0	2	=M18/O18		
18	16	8	=C17+(C23-C17)/26	=C19-C18	8.0-9.0	14	=D17	=H19+H18	=I19/\$I\$28	=J19*10.9	=L19-L18	24.0-27.0	4	=M19/O19		
19	17	9	=(C17+C23)/2	=C20-C19	9.0-10.0	16	=D19	=H20+H19	=I20/\$I\$28	=J20*10.9	=L20-L19	27.0-30.0	4	=M20/O20		
20	18	10	=C17+(C23-C17)/4/6	=C21-C20	10.0-11.0	18	=D21	=H21+H20	=I21/\$I\$28	=J21*10.9	=L21-L20	30.0-33.0	4	=M21/O21		
21	19	11	=C17+(C23-C17)/0.83	=C22-C21	11.0-12.0	20	=D23	=H22+H21	=I22/\$I\$28	=J22*10.9	=L22-L21	33.0-36.0	4	=M22/O22		
22	20	12	2.2	=C23-C22	12.0-14.0	21	=D24	=H23+H22	=I23/\$I\$28	=J23*10.9	=L23-L22	36.0-42.0	8	=M23/O23		
23	21	14	=C23+(C29-C23)/1/6	=C24-C23	14.0-16.0	22	=D25	=H24+H23	=I24/\$I\$28	=J24*10.9	=L24-L23	42.0-48.0	8	=M24/O24		
24	22	16	=C23+(C29-C23)/2/6	=C25-C24	16.0-18.0	23	=D26	=H25+H24	=I25/\$I\$28	=J25*10.9	=L25-L24	48.0-54.0	8	=M25/O25		
25	23	18	=(C23+C29)/2	=C26-C25	18.0-20.0	24	=D27	=H26+H25	=I26/\$I\$28	=J26*10.9	=L26-L25	54.0-60.0	8	=M26/O26		
26	24	20	=C23+(C29-C23)/4/6	=C27-C26	20.0-22.0	25	=D28	=H27+H26	=I27/\$I\$28	=J27*10.9	=L27-L26	60.0-66.0	8	=M27/O27		
27	25	22	=+C23+(C29-C23)/0.83	=C28-C27	22.0-24.0	26	=D29	=H28+H27	=I28/\$I\$28	=J28*10.9	=L28-L27	66.0-72.0	8	=M28/O28		
28	26	24	2.4	=C29-C28												

Adjustments for 24 hours to 72 hr conversion # of steps.

Sum period
applies weighting of distribution to 72-hr depth of p.p.r.
NUMBER OF TIME STEPS

Sum Depths
gives direction for REORDERING Depths.

from 100% to 72-hr precip calc.
(OTHERS ARE GEOMETRICALLY ESTIMATED)

time of step
step location

34

3.3.1.2.2 RAINFALL IN THE SIMPLIFIED PEAK FLOW METHOD

The Simplified Peak Flow method uses the 24-hour total depth of precipitation for the design frequency event. Obtain the 24-hour rainfall depth directly from the appropriate Figure in APPENDIX E. For NMSHTD projects, there is no reduction factor applied to 2-year, 5-year, and 10-year rainfall depths. This represents a slight departure from the original SCS method (SCS, 1985) adding a small measure of safety for frequent return period events.

The time distribution of rainfall is built into the Simplified Peak Flow method. This statewide rainfall distribution varies from 45% to over 85% of the 24-hour rainfall occurring in the peak hour of the storm as the Time of Concentration varies from 10 hours to 0.1 hours respectively.

3.3.1.2.3 RAINFALL IN THE SCS UNIT HYDROGRAPH METHOD

Proper application of this method requires use of a 24-hour rainfall event with the peak precipitation rate occurring at 6 hours. Rainfall data for the SCS Unit Hydrograph method consists of 24-hour point precipitation depths and a rainfall distribution. Point precipitation depths for the design return period may be obtained directly from the Figures in APPENDIX E.

For NMSHTD projects the rainfall distribution used with the SCS Unit Hydrograph method is called the Modified NOAA-SCS rainfall distribution. This Modified NOAA-SCS rainfall distribution is a combination of the peak rainfall intensity defined by NOAA, with an SCS Type II-a storm rearrangement. NOAA 6-hour and 24-hour point precipitation values are used to compute rainfall intensities throughout the hypothetical storm. These rainfall intensities are used to construct a depth-duration-frequency curve. Incremental rainfall depths are then reordered around the storm peak at 6 hours to create the Type II-a distribution.

The Modified NOAA-SCS rainfall distribution adjusts the peak hour rainfall intensity for each location in New Mexico. Peak hour point precipitation ranges from about 55% to almost 80%, depending on location. The original SCS method used a Type II-a distribution, where "a" represents the ratio of the 1-hour point precipitation to the 24-hour point precipitation, in percent. The SCS used a map (1973) to define areas of New Mexico where different rainfall distributions should be used. A Type II-60, Type II-65, Type II-70 or a Type II-75 distribution were defined for different physiographic regions of New Mexico. The procedure given in this manual results in a similar range of rainfall distributions which are less generalized. A comparison of the Modified NOAA-SCS rainfall distribution with "a" values from the original SCS map (1973) shows similar values in most locations around the state (Heggen, 1995, unpublished).

A manual method of computing the Modified NOAA-SCS rainfall distribution is described below. The NMSHTD Drainage Section has developed a spreadsheet to compute the Modified NOAA-SCS rainfall distribution (NMRAIN.WK4), given the 6-hour and 24-hour point precipitation values from Figures E-1 through E-12, or the current NOAA Atlas.

Manual Rainfall Distribution Procedure:

Step 1

Compute the 5-minute through 24-hour depths as described in *SECTION 3.3.1.2.1* for the desired return frequency event. Enter the depth values in the rainfall DDF worksheet. Use linear interpolation to find the rainfall depths associated with the time increments listed in column 2 of Figure 3-6.

Step 2

Enter the interpolated depth values in column 3 of the Worksheet. Subtract successive depth values (row 2 minus row 1, row 3 minus row 2, etc.) to obtain the incremental depth values (column 4).

Step 3

Copy incremental depth values from column 4 to column 7 of the worksheet. The first value in column 4 is copied to the cell in column 7 adjacent to the "rearranged n" value of 1 found in column 6, the second value in column 4 goes next to "rearranged n" value of 2, etc.

Step 4

The first value in column 8 will be the same as the first value in column 7. Thereafter, values in column 8 increase by the amount shown in column 7. Beginning at the top of the sheet, add each incremental depth value in column 7 to the previous cumulative depth in column 8 to obtain the new value of cumulative depth for column 8.

Column 8 now contains the rainfall distribution corresponding to the hyetograph time steps shown in column 5.

36

The Modified NOAA-SCS
Rainfall Distribution Worksheet

1	2	3	4	5	6	7	8
n	Time (duration) (hrs)	Cumulative Depth (inches)	Incremental Depth (inches)	Hyetograph time period (hrs)	Rearranged n	Incremental Depth (inches)	Cumulative Depth (inches)
0	0	0.0		0 - 1.0	19		
1	.25			1.0 - 2.0	17		
2	.50			2.0 - 3.0	15		
3	.75			3.0 - 4.0	13		
4	1.0			4.0 - 4.5	11		
5	1.25			4.5 - 5.0	9		
6	1.50			5.0 - 5.25	7		
7	1.75			5.25 - 5.50	5		
8	2.0			5.50 - 5.75	3		
9	2.5			5.75 - 6.0	1		
10	3.0			6.0 - 6.25	2		
11	3.5			6.25 - 6.50	4		
12	4.0			6.50 - 6.75	6		
13	5.0			6.75 - 7.0	8		
14	6.0			7.0 - 7.5	10		
15	7.0			7.5 - 8.0	12		
16	8.0			8.0 - 9.0	14		
17	9.0			9.0 - 10.0	16		
18	10.0			10.0 - 11.0	18		
19	11.0			11.0 - 12.0	20		
20	12.0			12.0 - 14.0	21		
21	14.0			14.0 - 16.0	22		
22	16.0			16.0 - 18.0	23		
23	18.0			18.0 - 20.0	24		
24	20.0			20.0 - 22.0	25		
25	22.0			22.0 - 24.0	26		
26	24.0						

Project Location: _____
 CN#: _____
 Date: _____
 Computed by: _____ Checked by: _____

Figure 3-6
The Modified
NOAA-SCS
Rainfall
Distribution
Worksheet

CALCULATION COVER SHEET

Client: Arizona Public Service Project Name: Fly Ash Ponds
 Project/Calculation Number: Four Corners Hydrology
 Title: HEC-1 ~~2D~~ Storage Volume Estimate
 Total Number of Pages (including cover sheet): 32
 Total Number of Computer Runs: _____
 Prepared by: Patrick Gorman Date: 16 Sep 02
 Checked by: [Signature] Date: 10-1-02

Description and Purpose:

Develop storage volumes based on PMP event.

Design Basis/References/Assumptions

SEE ATT.

Remarks/Conclusions/Results:

SEE ATT.

Calculation Approved by:

[Signature] PE, September 27, 2002
 Project Manager/Date
 Sr. Civil/Geotechnical Engineer, URS Albus, NM

Revision No.:

Description of Revision:

Approved by:

Project Manager/Date

4

Pond 5 spillway - selected depths
Worksheet for Trapezoidal Channel

Project Description	
Project File	c:\haestad\fmw\laps1.fm2
Worksheet	spillway0.5
Flow Element	Trapezoidal Channel
Method	Manning's Formula
Solve For	Discharge

Input Data	
Mannings Coefficient	0.040
Channel Slope	0.005000 ft/ft
Depth	0.60 ft
Left Side Slope	2.000000 H : V
Right Side Slope	2.000000 H : V
Bottom Width	210.00 ft

Results		
Discharge	235.69	cfs
Flow Area	126.72	ft ²
Wetted Perimeter	212.68	ft
Top Width	212.40	ft
Critical Depth	0.34	ft
Critical Slope	0.033499	ft/ft
Velocity	1.86	ft/s
Velocity Head	0.05	ft
Specific Energy	0.65	ft
Froude Number	0.42	
Flow is subcritical.		

5

Pond 5 spillway - selected depths
Worksheet for Trapezoidal Channel

Project Description	
Project File	c:\haestad\fmw\laps1.fm2
Worksheet	spillway0.5
Flow Element	Trapezoidal Channel
Method	Manning's Formula
Solve For	Discharge

Input Data	
Mannings Coefficient	0.040
Channel Slope	0.005000 ft/ft
Depth	0.60 ft
Left Side Slope	2.000000 H : V
Right Side Slope	2.000000 H : V
Bottom Width	145.00 ft

Results		
Discharge	162.82	cfs
Flow Area	87.72	ft ²
Wetted Perimeter	147.68	ft
Top Width	147.40	ft
Critical Depth	0.34	ft
Critical Slope	0.033532	ft/ft
Velocity	1.86	ft/s
Velocity Head	0.05	ft
Specific Energy	0.65	ft
Froude Number	0.42	
Flow is subcritical.		

6

Pond 5 spillway - selected depths
Worksheet for Trapezoidal Channel

Project Description	
Project File	c:\haestad\fmw\aps1.fm2
Worksheet	spillway0.5
Flow Element	Trapezoidal Channel
Method	Manning's Formula
Solve For	Discharge

Input Data	
Mannings Coefficient	0.040
Channel Slope	0.005000 ft/ft
Depth	1.20 ft
Left Side Slope	2.000000 H : V
Right Side Slope	2.000000 H : V
Bottom Width	145.00 ft

Results		
Discharge	517.75	cfs
Flow Area	176.88	ft ²
Wetted Perimeter	150.37	ft
Top Width	149.80	ft
Critical Depth	0.73	ft
Critical Slope	0.026036	ft/ft
Velocity	2.93	ft/s
Velocity Head	0.13	ft
Specific Energy	1.33	ft
Froude Number	0.47	
Flow is subcritical.		

The map showing the delineation of drainage basins and facility locations is provided as Figure 1 of the letter. The map was not reproduced for the calculation in this Appendix.

TER

HC 3
 KK PONDS
 KM EVALUATION OF STORAGE IN POND 5.
 KM OVERFLOW THROUGH A SPILLWAY, WITH MAXIMUM DEPTH OF 1.2 FT.
 KM FLOWS ARE BASED ON A CHANNEL SPILLWAY WITH 0.5 PERCENT BOTTOM SLOPE
 KM AND A SPILLWAY BOTTOM WIDTH OF 210 FEET.
 KM OUTFLOW AT 5253 IS APPROXIMATED.

RS	1	STOR	0					
SV	0	11.5	18.5	28.2	42.9			
SE	5242	5250	5250.6	5251.2	5252			
SQ	0	0	236	749	1000			
KK	G							

← capacity of spillway sufficient to maintain 2.8' of freeboard. SEE FlowMaster sheets of this (estimated) calculation package.

KM AREA UPSTREAM OF POND 6.

BA	0.027							
LS	0	95	0					
UD	0.17							
PR	PMP							
PW	1							
KK	F							

KM AREA UPSTREAM OF POND 6.

BA	0.059							
LS	0	95	0					
UD	0.17							
PR	PMP							
PW	1							
KK	E							

KM AREA ENCOMPASSED BY POND 6.

BA	0.220							
LS	0	95	100					
UD	0.25							
PR	PMP							
PW	1							
KK	GFE							

← full impervious.

KM COMBINES THE SUBBASINS G, F, AND E WITH THOSE OF LKJ

HC 4
 KK POND6

(KM EVALUATION OF STORAGE IN POND 6. ALL RUNOFF CONTAINED, NO OUTFLOW.)

RS	1	ELEV	5220					
SV	5.01	77.5	276.9	394.1	520.7	650.9	782.8	914.6
SE	5216	5218	5220	5221	5222	5223	5224	5225
SQ	0	0	0	0	0	0	0	10000
ZZ								

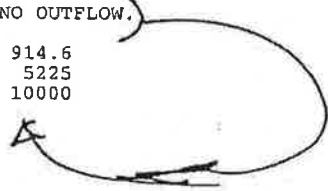

Note: The model was run assuming a bottom ash elevation of 5,220 ft. Therefore, the final storage volume after runoff is 621 ac-ft. The net runoff volume is 344 ac-ft from the 72-hr PMF. The final bottom ash elevation can be adjusted to achieve 2.8 ft of freeboard.

10

```

.....
FLOOD HYDROGRAPH PACKAGE (HEC-1)
SEPTEMBER 1990
VERSION 4.0
RUN DATE 09/16/2002 TIME 11:28:55
.....

```

```

* U.S. ARMY CORPS OF ENGINEERS
* HYDROLOGIC ENGINEERING CENTER
* 609 SECOND STREET
* DAVIS, CALIFORNIA 95616
* (916) 756-1104

```

```

X X XXXXXXX XXXXX X
X X X X X XX
X X X X X
XXXXXXXX XXXX X XXXXX X
X X X X X
X X X X X
X X XXXXXXX XXXXX XXX

```

THIS PROGRAM REPLACES ALL PREVIOUS VERSIONS OF HEC-1 KNOWN AS HEC1 (JAN 73), HEC1G, HEC1DB, AND HEC1KW.

THE DEFINITIONS OF VARIABLES -RTIMP- AND -RTIOR- HAVE CHANGED FROM THOSE USED WITH THE 1973-STYLE INPUT STRUCTURE. THE DEFINITION OF -AMSK- ON RM-CARD WAS CHANGED WITH REVISIONS DATED 28 SEP 81. THIS IS THE FORTRAN77 VERSION NEW OPTIONS: DAMBREAK OUTFLOW SUBMERGENCE, SINGLE EVENT DAMAGE CALCULATION, DSS:WRITE STAGE FREQUENCY, DSS:READ TIME SERIES AT DESIRED CALCULATION INTERVAL LOSS RATE:GREEN AND AMPT INFILTRATION KINEMATIC WAVE: NEW FINITE DIFFERENCE ALGORITHM

1

HEC-1 INPUT

```

LINE ID .....1.....2.....3.....4.....5.....6.....7.....8.....9.....10
1 ID .....
2 ID * ARIZONA PUBLIC SERVICE *
3 ID * FOUR CORNERS FLY ASH PONDS *
4 ID * JOB NO. *
5 ID .....
6 ID .....
7 ID DEVELOP THE RUNOFF HYDROGRAPH FOR THE FLY ASH PONDS
8 ID .....
9 ID THE RAINFALL HYETOGRAPH IS FOR THE PMP STORM DERIVED USING THE SCS UNI
10 ID HYDROGRAPH METHOD
11 ID .....
12 ID CATCHMENT AREAS ARE MEASURED FROM THE SITE MAP PROVIDED BY APS
13 ID .....
14 ID LAG TIMES HAVE BEEN ESTIMATED AS BEING 60 PERCENT OF THE TIME OF CONCE
15 ID AS CALCULATED USING THE KIRPICH METHOD
16 ID .....
17 ID THIS FILE MODELS THE EXISTING CONFIGURATION WITHOUT DIVERSION OF HEADW
18 ID .....
19 ID THE OVERFLOW STRUCTURE FROM POND 5 IS A SPILLWAY
20 ID .....
21 ID IMPERMEABLE AREAS ARE DUE TO ESTIMATED STORMWATER PONDING AREAS
22 ID .....
23 ID FILENAME: PMPNODIV.DAT
24 IT 45 01JAN00 0 100
25 IO 3
26 VS LKJ POND5 POND5 GPE POND6 K
27 VV 2 2 6 2 6 3
28 PG PMP 0 0
29 PI 0.038 0.038 0.038 0.038 0.038 0.038 0.038 0.038 0.038 0.038
30 PI 0.018 0.038 0.016 0.016 0.016 0.016 0.016 0.016 0.016 0.016
31 PI 0.062 0.062 0.057 0.057 0.102 0.102 1.135 4.542 1.135 1.135
32 PI 0.102 0.102 0.057 0.057 0.062 0.062 0.031 0.031 0.031 0.031
33 PI 0.038 0.038 0.038 0.038 0.038 0.038 0.038 0.038 0.038 0.038
34 PI 0.038 0.038 0.019 0.019 0.019 0.019 0.019 0.019 0.019 0.019
35 PI 0.019 0.019 0.019 0.019 0.019 0.019 0.019 0.019 0.019 0.019
36 PI 0.019 0.019 0.019 0.019 0.019 0.019 0.019 0.019 0.019 0.019
37 PI 0.019 0.019 0.019 0.019 0.019 0.019 0.019 0.019 0.019 0.019
38 PI 0.019 0.019 0.019 0.019 0.019 0.019 0.019 0.019 0.019 0.019
39 PI 0.00 0.00 0.00 0.00 0.00 0.00 0.00 0.00 0.00 0.00
40 PI 0.00 0.00 0.00 0.00 0.00 0.00 0.00 0.00 0.00 0.00
41 PI 0.00 0.00 0.00 0.00 0.00 0.00 0.00 0.00 0.00 0.00
42 PI 0.00 0.00 0.00 0.00 0.00 0.00 0.00 0.00 0.00 0.00
43 PI 0.00 0.00 0.00 0.00 0.00 0.00 0.00 0.00 0.00 0.00
44 PI 0.00 0.00 0.00 0.00 0.00 0.00 0.00 0.00 0.00 0.00
45 PI 0.00 0.00 0.00 0.00 0.00 0.00 0.00 0.00 0.00 0.00
46 PI 0.00 0.00 0.00 0.00 0.00 0.00 0.00 0.00 0.00 0.00
47 PI 0.00 0.00 0.00 0.00 0.00 0.00 0.00 0.00 0.00 0.00
48 PI 0.00 0.00 0.00 0.00 0.00 0.00 0.00 0.00 0.00 0.00
49 PI 0.00 0.00 0.00 0.00 0.00 0.00 0.00 0.00 0.00 0.00
50 PI 0.00 0.00 0.00 0.00 0.00 0.00 0.00 0.00 0.00 0.00
51 PI 0.00 0.00 0.00 0.00 0.00 0.00 0.00 0.00 0.00 0.00
52 PI 0.00 0.00 0.00 0.00 0.00 0.00 0.00 0.00 0.00 0.00
53 PI 0.00 0.00 0.00 0.00 0.00 0.00 0.00 0.00 0.00 0.00
54 PI 0.00 0.00 0.00 0.00 0.00 0.00 0.00 0.00 0.00 0.00
55 PI 0.00 0.00 0.00 0.00 0.00 0.00 0.00 0.00 0.00 0.00

```

out part

1

HEC-1 INPUT

```

LINE ID .....1.....2.....3.....4.....5.....6.....7.....8.....9.....10
56 PI 0.00 0.00 0.00 0.00 0.00 0.00 0.00 0.00 0.00 0.00
57 PI 0.00 0.00 0.00 0.00 0.00 0.00 0.00 0.00 0.00 0.00

```

16

```

58      PI      0.00  0.00  0.00  0.00  0.00  0.00  0.00  0.00  0.00  0.00
59      KK      L
60      KM      AREA UPSTREAM OF POND 5. NO DIVERSION OF UNIMPACTED STORMWATER.
61      BA      0.169
62      LS      0      95      0
63      UD      0.17
64      PR      PHP
65      PW      1

66      KK      X
67      KM      AREA UPSTREAM OF POND 5.
68      BA      0.103
69      LS      0      95      24
70      UD      0.17
71      PR      PHP
72      PW      1

73      KK      J
74      KM      AREA ENCOMPASSED BY POND 5.
75      BA      0.052
76      LS      0      95      80
77      UD      0.25
78      PR      PHP
79      PW      1

80      KK      LKJ
81      KM      COMBINES THE SUBBASINS L, X, AND J
82      HC      3

83      KK      FOND5
84      KM      EVALUATION OF STORAGE IN POND 5.
85      KM      OVERFLOW THROUGH A SPILLWAY, WITH MAXIMUM DEPTH OF 1.2 FT.
86      KM      FLOWS ARE BASED ON A CHANNEL SPILLWAY WITH 0.5 PERCENT BOTTOM SLOPE
87      KM      AND A SPILLWAY BOTTOM WIDTH OF 210 FEET.
88      KM      OUTFLOW AT 5253 IS APPROXIMATED.
89      RS      1      STOR      0
90      SV      0      11.5      18.5      28.2      42.9
91      SE      5242      5250      5250.6      5251.2      5252
92      SQ      0      0      236      749      1000

93      KK      G
94      KM      AREA UPSTREAM OF POND 6.
95      BA      0.027
96      LS      0      95      0
97      UD      0.17
98      PR      PHP
99      PW      1

```

HEC-1 INPUT

PAGE 3

1

```

LINE      ID.....1.....2.....3.....4.....5.....6.....7.....8.....9.....10
100      KK      F
101      KM      AREA UPSTREAM OF POND 6.
102      BA      0.052
103      LS      0      95      0
104      UD      0.17
105      PR      PHP
106      PW      1

107      KK      E
108      KM      AREA ENCOMPASSED BY POND 6.
109      BA      0.270
110      LS      0      95      100
111      UD      0.25
112      PR      PHP
113      PW      1

114      KK      GPE
115      KM      COMBINES THE SUBBASINS G, F, AND E WITH THOSE OF LKJ
116      HC      4

117      KK      FOND6
118      KM      EVALUATION OF STORAGE IN POND 6. ALL RUNOFF CONTAINED, NO OUTFLOW.
119      RS      1      ELEV      5220
120      SV      5.01      77.5      276.9      394.1      520.7      650.9      782.8      914.6
121      SE      5216      5218      5220      5221      5222      5223      5224      5225
122      SQ      0      0      0      0      0      0      0      10000
123      ZZ

```

```

.....
FLOOD HYDROGRAPH PACKAGE (HEC-1)
SEPTEMBER 1990
VERSION 4.0

RUN DATE 09/16/2002 TIME 11:28:55
.....

```

```

U.S. ARMY CORPS OF ENGINEERS
HYDROLOGIC ENGINEERING CENTER
609 SECOND STREET
DAVIS, CALIFORNIA 95616
(916) 756-1104

```

```

*****
* ARIZONA PUBLIC SERVICE *
* FOUR CORNERS FLY ASH PONDS *
* JOB NO. *
*****

```

DEVELOP THE RUNOFF HYDROGRAPH FOR THE FLY ASH PONDS
 THE RAINFALL HYETOGRAPH IS FOR THE PMP STORM DERIVED USING THE SCS UNIT
 HYDROGRAPH METHOD
 CATCHMENT AREAS ARE MEASURED FROM THE SITE MAP PROVIDED BY APS
 LAG TIMES HAVE BEEN ESTIMATED AS BEING 60 PERCENT OF THE TIME OF CONCENTRATION
 AS CALCULATED USING THE KIRPICH METHOD
 THIS FILE MODELS THE EXISTING CONFIGURATION WITHOUT DIVERSION OF HEADWATER
 THE OVERFLOW STRUCTURE FROM POND 5 IS A SPILLWAY
 IMPERMEABLE AREAS ARE DUE TO ESTIMATED STORMWATER PONDING AREAS

FILENAME: PMPNODIV.DAT

25 IO OUTPUT CONTROL VARIABLES
 IERRNT 3 PRINT CONTROL
 IPLOT 0 PLOT CONTROL
 QSCAL 0. HYDROGRAPH PLOT SCALE

IT HYDROGRAPH TIME DATA
 NMIN 45 MINUTES IN COMPUTATION INTERVAL
 IDATE 1JAN 0 STARTING DATE
 ITIME 0000 STARTING TIME
 NQ 100 NUMBER OF HYDROGRAPH ORDINATES
 NDDATE 10JAN 0 ENDING DATE
 NDTIME 0815 ENDING TIME
 ICENT 19 CENTURY MARK

COMPUTATION INTERVAL .75 HOURS
 TOTAL TIME BASE 224.25 HOURS

ENGLISH UNITS
 DRAINAGE AREA SQUARE MILES
 PRECIPITATION DEPTH INCHES
 LENGTH, ELEVATION FEET
 FLOW CUBIC FEET PER SECOND
 STORAGE VOLUME ACRE-Feet
 SURFACE AREA ACRES
 TEMPERATURE DEGREES FAHRENHEIT

USER-DEFINED OUTPUT SPECIFICATIONS

TABLE 1

VS STATION	LKJ	POND5	POND6	GFE	POND6	K				
VV VARIABLE CODE	2.00	2.00	6.00	2.00	6.00	3.00	.00	.00	.00	.00

59 KK

 AREA UPSTREAM OF POND 5. NO DIVERSION OF UNIMPACTED STORMWATER.

SUBBASIN RUNOFF DATA

61 BA SUBBASIN CHARACTERISTICS
 TAREA .17 SUBBASIN AREA

PRECIPITATION DATA

64 PR RECORDING STATIONS PMP
 65 PW WEIGHTS 1.00

62 LS SCS LOSS RATE
 STRTL .11 INITIAL ABSTRACTION
 CRVNR 95.00 CURVE NUMBER
 RTMP .00 PERCENT IMPERVIOUS AREA

63 UD SCS DIMENSIONLESS UNITGRAPH
 TLAG .17 LAG

PRECIPITATION STATION DATA

STATION	TOTAL	AVG. ANNUAL	WEIGHT
PMP	10.91	.00	1.00

TEMPORAL DISTRIBUTIONS

STATION	PMP	WEIGHT	= 1.00							
.04	.04	.04	.04	.04	.04	.04	.04	.04	.04	.04
.04	.04	.02	.02	.02	.02	.02	.02	.02	.02	.02
.06	.06	.06	.06	.10	.10	1.13	4.54	1.13	1.14	1.14
.10	.10	.06	.06	.06	.06	.03	.03	.03	.03	.03
.04	.04	.04	.04	.04	.04	.04	.04	.04	.04	.04
.04	.04	.02	.02	.02	.02	.02	.02	.02	.02	.02
.02	.02	.02	.02	.02	.02	.02	.02	.02	.02	.02
.02	.02	.02	.02	.02	.02	.02	.02	.02	.02	.02
.02	.02	.02	.02	.02	.02	.02	.02	.02	.02	.02
.02	.02	.02	.02	.02	.02	.02	.02	.02	.02	.02

UNIT HYDROGRAPH
 5 END-OF-PERIOD ORDINATES
 0.

108. 10. 6. 1. 0.
 *** **

HYDROGRAPH AT STATION L

TOTAL RAINFALL = 10.91, TOTAL LOSS = .61, TOTAL EXCESS = 10.30

PEAK FLOW (CFS)	TIME (HR)	(CFS)	6-HR	MAXIMUM AVERAGE FLOW 24-HR	72-HR	224.25-HR
516.	21.00	148.	42.	16.	5.	
		(INCHES)	3.136	9.147	10.290	10.300
		(AC-FT)	73.	82.	93.	93.

CUMULATIVE AREA = .17 SQ MI

.....

66 KX



AREA UPSTREAM OF POND 5.

SUBBASIN RUNOFF DATA

68 BA SUBBASIN CHARACTERISTICS
TAREA .10 SUBBASIN AREA

PRECIPITATION DATA

71 ER RECORDING STATIONS PMP
72 FW WEIGHTS 1.00

69 LS SCS LOSS RATE
STRTL .11 INITIAL ABSTRACTION
CRUNDR 95.00 CURVE NUMBER
RTIMP 24.00 PERCENT IMPERVIOUS AREA

70 UD SCS DIMENSIONLESS UNITGRAPH
FLAG .17 LAG

PRECIPITATION STATION DATA

STATION PMP	TOTAL 10.91	AVG. ANNUAL .00	WEIGHT 1.00
----------------	----------------	--------------------	----------------

TEMPORAL DISTRIBUTIONS

STATION	PMP	WEIGHT	SCS DIMENSIONLESS UNITGRAPH																	
.04	.04	.04	.04	.04	.04	.04	.04	.04	.04	.04	.04	.04	.04	.04	.04	.04	.04	.04	.04	.04
.04	.04	.02	.02	.02	.02	.02	.02	.02	.02	.02	.02	.02	.02	.02	.02	.02	.02	.02	.02	.02
.05	.06	.06	.06	.06	.10	.10	1.13	4.54	1.13	1.14	.03	.03	.03	.03	.03	.03	.03	.03	.03	.03
.10	.10	.06	.06	.06	.06	.06	.06	.06	.06	.06	.06	.06	.06	.06	.06	.06	.06	.06	.06	.06
.04	.04	.04	.04	.04	.04	.04	.04	.04	.04	.04	.04	.04	.04	.04	.04	.04	.04	.04	.04	.04
.04	.04	.02	.02	.02	.02	.02	.02	.02	.02	.02	.02	.02	.02	.02	.02	.02	.02	.02	.02	.02
.02	.02	.02	.02	.02	.02	.02	.02	.02	.02	.02	.02	.02	.02	.02	.02	.02	.02	.02	.02	.02
.02	.02	.02	.02	.02	.02	.02	.02	.02	.02	.02	.02	.02	.02	.02	.02	.02	.02	.02	.02	.02
.02	.02	.02	.02	.02	.02	.02	.02	.02	.02	.02	.02	.02	.02	.02	.02	.02	.02	.02	.02	.02
.02	.02	.02	.02	.02	.02	.02	.02	.02	.02	.02	.02	.02	.02	.02	.02	.02	.02	.02	.02	.02

UNIT HYDROGRAPH
5 END-OF-PERIOD ORDINATES
0.

66.

HYDROGRAPH AT STATION K

TOTAL RAINFALL = 10.91, TOTAL LOSS = .46, TOTAL EXCESS = 10.45

PEAK FLOW (CFS)	TIME (HR)	(CFS)	6-HR	MAXIMUM AVERAGE FLOW 24-HR	72-HR	224.25-HR
316.	21.00	91.	25.	10.	3.	
		(INCHES)	8.182	9.206	10.400	10.446
		(AC-FT)	45.	51.	57.	57.

CUMULATIVE AREA = .10 SQ MI

.....

73 KK

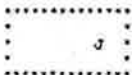

AREA ENCOMPASSED BY POND 5.

SUBBASIN RUNOFF DATA

75 BA SUBBASIN CHARACTERISTICS
TAREA .05 SUBBASIN AREA

PRECIPITATION DATA

78 PR RECORDING STATIONS PMP
 79 PH WEIGHTS 1.00
 76 LS SCS LOSS RATE
 STRFL .11 INITIAL ABSTRACTION
 CAVNBR .95.00 CURVE NUMBER
 RTIMP .80.00 PERCENT IMPERVIOUS AREA
 77 UD SCS DIMENSIONLESS UNITGRAPH
 FLAG .25 LAG

PRECIPITATION STATION DATA

STATION	TOTAL	AVG. ANNUAL	WEIGHT
PMP	10.91	.68	1.00

TEMPORAL DISTRIBUTIONS

STATION	PMP	WEIGHT	1.00							
.04	.04	.04	.04	.04	.04	.04	.04	.04	.04	.04
.04	.04	.02	.02	.02	.02	.02	.02	.02	.02	.02
.06	.06	.06	.06	.10	.10	1.13	4.54	1.13	1.14	
.10	.10	.06	.06	.06	.06	.03	.03	.03	.01	
.04	.04	.04	.04	.04	.04	.04	.04	.04	.04	
.04	.04	.02	.02	.02	.02	.02	.02	.02	.02	
.02	.02	.02	.02	.02	.02	.02	.02	.02	.02	
.02	.02	.02	.02	.02	.02	.02	.02	.02	.02	
.02	.02	.02	.02	.02	.02	.02	.02	.02	.02	
.02	.02	.02	.02	.02	.02	.02	.02	.02	.02	

UNIT HYDROGRAPH
 5 END-OF-PERIOD ORDINATES
 0

33.	9.	2.	0.
-----	----	----	----

HYDROGRAPH AT STATION J

TOTAL RAINFALL = 10.91, TOTAL LOSS = .12, TOTAL EXCESS = 10.79
 PEAK FLOW TIME MAXIMUM AVERAGE FLOW
 (CFS) (HR) 6-HR 24-HR 72-HR 224.25-HR
 + 161. 21.00 46. 13. 5. 2.
 (INCHES) 8.288 9.143 10.702 10.786
 (AC-FT) 23. 26. 30. 30.
 CUMULATIVE AREA = .05 SQ MI

80 MK



COMBINES THE SUBBASINS L, K, AND J

82 HC

HYDROGRAPH COMBINATION
 ICCMP 3 NUMBER OF HYDROGRAPHS TO COMBINE

HYDROGRAPH AT STATION LKJ

PEAK FLOW TIME MAXIMUM AVERAGE FLOW
 (CFS) (HR) 6-HR 24-HR 72-HR 224.25-HR
 + 993. 21.00 285. 80. 30. 10.
 (INCHES) 8.175 9.197 10.383 10.424
 (AC-FT) 141. 159. 179. 180.
 CUMULATIVE AREA = .32 SQ MI

83 KX

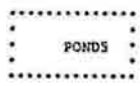

EVALUATION OF STORAGE IN POND 5.
 OVERFLOW THROUGH A SPILLWAY, WITH MAXIMUM DEPTH OF 1.2 FT.
 FLOWS ARE BASED ON A CHANNEL SPILLWAY WITH 0.3 PERCENT BOTTOM SLOPE
 AND A SPILLWAY BOTTOM WIDTH OF 210 FEET.
 OUTFLOW AT 5251 IS APPROXIMATED.

HYDROGRAPH ROUTING DATA

89 RB

STORAGE ROUTING
 NSTPS 2 NUMBER OF SUBREACHES
 ITYP STOR TYPE OF INITIAL CONDITION

(AC-FT) 12. 13. 15. 15.
 CUMULATIVE AREA = .03 SQ MI

100 XK

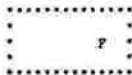

AREA UPSTREAM OF POND 6.

SUBBASIN RUNOFF DATA

102 BA SUBBASIN CHARACTERISTICS
 TAREA .06 SUBBASIN AREA

PRECIPITATION DATA

105 PR RECORDING STATIONS PMP
 106 PW WEIGHTS 1.00

103 LS SCS LOSS RATE
 STRTL .11 INITIAL ABSTRACTION
 CRVNR 95.00 CURVE NUMBER
 RTIMP .00 PERCENT IMPERVIOUS AREA

104 UD SCS DIMENSIONLESS UNITGRAPH
 TLAG .17 LAG

PRECIPITATION STATION DATA

STATION	TOTAL	AVG. ANNUAL	WEIGHT
PMP	10.91	.00	1.00

TEMPORAL DISTRIBUTIONS

STATION	PHP	WEIGHT	= 1.00							
.04	.04	.04	.04	.04	.04	.04	.04	.04	.04	.04
.04	.04	.02	.02	.02	.02	.02	.02	.02	.02	.02
.06	.06	.06	.06	.10	.10	1.13	4.54	1.13	1.14	1.14
.10	.10	.06	.06	.06	.06	.03	.03	.03	.03	.03
.04	.04	.04	.04	.04	.04	.04	.04	.04	.04	.04
.04	.04	.02	.02	.02	.02	.02	.02	.02	.02	.02
.02	.02	.02	.02	.02	.02	.02	.02	.02	.02	.02
.02	.02	.02	.02	.02	.02	.02	.02	.02	.02	.02
.02	.02	.02	.02	.02	.02	.02	.02	.02	.02	.02
.02	.02	.02	.02	.02	.02	.02	.02	.02	.02	.02

UNIT HYDROGRAPH
 5 END-OF-PERIOD ORDINATES

38. 11. 2. 0.

HYDROGRAPH AT STATION F

TOTAL RAINFALL = 10.91, TOTAL LOSS = .61, TOTAL EXCESS = 10.30

PEAK FLOW + (CFS)	TIME (HR)	MAXIMUM AVERAGE FLOW			
		5-HR	24-HR	72-HR	224.25-HR
+ 180.	21.00	52. (INCHES) [AC-FT] 26.	15. 9.147 29.	5. 10.290 32.	2. 10.300 31.

CUMULATIVE AREA = .06 SQ MI

107 XK

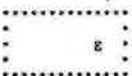

AREA ENCOMPASSED BY POND 6.

SUBBASIN RUNOFF DATA

109 BA SUBBASIN CHARACTERISTICS
 TAREA .22 SUBBASIN AREA

PRECIPITATION DATA

112 PR RECORDING STATIONS PMP
 113 PW WEIGHTS 1.00

110 LS SCS LOSS RATE
 STRTL .11 INITIAL ABSTRACTION
 CRVNR 95.00 CURVE NUMBER
 RTIMP 100.00 PERCENT IMPERVIOUS AREA

111 UD SCS DIMENSIONLESS UNITGRAPH
 TLAG .25 LAG

PRECIPITATION STATION DATA

STATION	TOTAL	AVG. ANNUAL	WEIGHT
PMP	10.91	.00	1.00

TEMPORAL DISTRIBUTIONS

STATION	PMP	WEIGHT	= 1.00							
.04	.04	.04	.04	.04	.04	.04	.04	.04	.04	.04
.04	.04	.02	.02	.02	.02	.02	.02	.02	.02	.02
.06	.06	.06	.06	.10	.10	1.13	4.54	1.13	1.14	
.10	.10	.06	.06	.06	.06	.03	.03	.03	.03	
.04	.04	.04	.04	.04	.04	.04	.04	.04	.04	
.04	.04	.02	.02	.02	.02	.02	.02	.02	.02	
.02	.02	.02	.02	.02	.02	.02	.02	.02	.02	
.02	.02	.02	.02	.02	.02	.02	.02	.02	.02	
.02	.02	.02	.02	.02	.02	.02	.02	.02	.02	
.02	.02	.02	.02	.02	.02	.02	.02	.02	.02	

UNIT HYDROGRAPH
5 END-OF-PERIOD ORDINATES
0.

141. 39. 8. 2. 0.

HYDROGRAPH AT STATION E

TOTAL RAINFALL = 10.91, TOTAL LOSS = .00, TOTAL EXCESS = 10.91

PEAK FLOW	TIME	6-HR	24-HR	72-HR	224.25-HR
(CFS)	(HR)	(CFS)	(CFS)	(CFS)	(CFS)
584.	21.00	197.	56.	21.	7.
		(INCHES)	8.326	9.393	10.820
		(AC-FT)	98.	110.	127.
					10.907
					128.
		CUMULATIVE AREA =	.22 SQ MI		

114 KK GFE

COMBINES THE SUBBASINS G, F, AND E WITH THOSE OF LKJ

116 HC HYDROGRAPH COMBINATION
ICOMP 4 NUMBER OF HYDROGRAPHS TO COMBINE

HYDROGRAPH AT STATION GFE

PEAK FLOW	TIME	6-HR	24-HR	72-HR	224.25-HR
(CFS)	(HR)	(CFS)	(CFS)	(CFS)	(CFS)
1651.	21.00	551.	154.	57.	19.
		(INCHES)	8.155	9.071	10.171
		(AC-FT)	274.	305.	342.
					10.234
					144.
		CUMULATIVE AREA =	.63 SQ MI		

117 XK POND6

EVALUATION OF STORAGE IN POND 6. ALL RUNOFF CONTAINED, NO OUTFLOW.

HYDROGRAPH ROUTING DATA

STORAGE ROUTING	I	NUMBER OF SUBREACHES							
NSTPS	ELEV	TYPE OF INITIAL CONDITION							
ITYP	5220.00	INITIAL CONDITION							
RSVVIC	.00	WORKING R AND D COEFFICIENT							
X									
120 SV STORAGE	5.0	77.5	276.9	194.1	520.7	650.9	782.8	914.6	
121 SE ELEVATION	5216.00	5218.00	5220.00	5221.00	5222.00	5223.00	5224.00	5225.00	
122 SQ DISCHARGE	0.	0.	0.	0.	0.	0.	0.	10000.	

*** WARNING *** MODIFIED PULS ROUTING MAY BE NUMERICALLY UNSTABLE FOR OUTFLOWS BETWEEN 0. TO 10000. THE ROUTED HYDROGRAPH SHOULD BE EXAMINED FOR OSCILLATIONS OR OUTFLOWS GREATER THAN PEAK INFLOWS. THIS CAN BE CORRECTED BY DECREASING THE TIME INTERVAL OR INCREASING STORAGE (USE A LONGER REACH.)

** -> No outflow from pond 6. Only concerned with volume. Therefore, warning does not impact results.

HYDROGRAPH AT STATION POND6

PEAK FLOW	TIME	6-HR	24-HR	72-HR	224.25-HR
+	(CFS)	(CFS)	MAXIMUM	AVERAGE	FLOW
+	0.	.75	0.	0.	0.
	(HR)	(HR)	0.000	0.000	0.000
			(INCHES)	0.000	0.000
			(AC-FT)	0.	0.
PEAK STORAGE	TIME	6-HR	24-HR	72-HR	224.25-HR
+	(AC-FT)	(HR)	MAXIMUM	AVERAGE	STORAGE
+	621.	78.00	621.	621.	582.
PEAK STAGE	TIME	6-HR	24-HR	72-HR	224.25-HR
+	(FEET)	(HR)	MAXIMUM	AVERAGE	STAGE
+	5222.77	77.25	5222.77	5222.78	5222.45

CUMULATIVE AREA = .63 SQ MI

RUNOFF SUMMARY
FLOW IN CUBIC FEET PER SECOND
TIME IN HOURS, AREA IN SQUARE MILES

OPERATION	STATION	PEAK FLOW	TIME OF PEAK	AVERAGE FLOW FOR MAXIMUM PERIOD			BASIN AREA	MAXIMUM STAGE	TIME OF MAX STAGE
				6-HOUR	24-HOUR	72-HOUR			
+	HYDROGRAPH AT L	516.	21.00	148.	42.	16.	.17		
+	HYDROGRAPH AT K	316.	21.00	91.	25.	10.	.10		
+	HYDROGRAPH AT J	161.	21.00	46.	13.	5.	.05		
+	3 COMBINED AT LKJ	991.	21.00	285.	80.	30.	.32		
+	ROUTED TO POND5	756.	21.75	281.	78.	28.	.32	5251.22	21.75
+	HYDROGRAPH AT G	82.	21.00	24.	7.	2.	.03		
+	HYDROGRAPH AT F	180.	21.00	52.	15.	5.	.06		
+	HYDROGRAPH AT E	684.	21.00	197.	56.	21.	.22		
+	4 COMBINED AT GFE	1651.	21.00	553.	154.	57.	.63		
+	ROUTED TO POND6	0.	.75	0.	0.	0.	.63	5222.77	77.25

TABLE 1

PER DAY MON HRMN	STATION	LKJ FLOW	POND5 FLOW	POND5 STORAGE	GFE FLOW	POND6 STORAGE	K RAIN
1	1 JAN 0000	.00	.00	.00	.00	276.90	.00
2	1 JAN 0045	1.61	.00	.05	5.34	277.07	.04
3	1 JAN 0130	2.06	.00	.15	6.84	277.44	.04
4	1 JAN 0215	2.17	.00	.30	7.14	277.88	.04
5	1 JAN 0300	2.78	.00	.45	7.40	278.33	.04
6	1 JAN 0345	1.65	.00	.65	7.69	278.79	.04
7	1 JAN 0430	4.46	.00	.90	7.96	279.28	.04
8	1 JAN 0515	5.25	.00	1.20	8.19	279.78	.04
9	1 JAN 0600	5.73	.00	1.53	8.38	280.29	.04
10	1 JAN 0645	6.22	.00	1.90	8.55	280.82	.04
11	1 JAN 0730	6.65	.00	2.30	8.69	281.35	.04
12	1 JAN 0815	7.01	.00	2.73	8.81	281.89	.04
13	1 JAN 0900	7.32	.00	3.17	8.91	282.44	.04
14	1 JAN 0945	4.27	.00	3.53	5.11	282.88	.02
15	1 JAN 1030	3.44	.00	3.77	4.06	283.36	.02
16	1 JAN 1115	3.31	.00	3.98	3.86	283.41	.02
17	1 JAN 1200	3.32	.00	4.18	3.83	283.65	.02
18	1 JAN 1245	3.36	.00	4.39	3.84	283.88	.02
19	1 JAN 1330	3.39	.00	4.60	3.86	284.12	.02
20	1 JAN 1415	3.43	.00	4.81	3.87	284.36	.02
21	1 JAN 1500	3.46	.00	5.02	3.88	284.60	.02
22	1 JAN 1545	11.09	.00	5.48	12.25	285.10	.06
23	1 JAN 1630	13.52	.00	6.24	14.68	285.94	.06
24	1 JAN 1715	13.39	.00	7.07	14.33	286.84	.06
25	1 JAN 1800	13.49	.00	7.91	14.25	287.72	.06
26	1 JAN 1845	21.81	.00	9.00	22.68	288.87	.10
27	1 JAN 1930	24.53	.00	10.44	25.18	290.35	.10
28	1 JAN 2015	227.59	111.29	14.80	335.21	301.52	1.13
29	1 JAN 2100	992.65	704.03	27.35	1650.88	363.07	4.54
30	1 JAN 2145	506.83	755.58	28.59	1237.19	452.58	1.13
31	1 JAN 2230	353.94	356.82	20.78	691.55	512.35	1.14
32	1 JAN 2315	109.82	207.56	17.66	311.52	543.44	.10
33	2 JAN 0000	42.45	73.25	13.67	113.40	556.61	.10
34	2 JAN 0045	21.42	31.02	12.42	51.28	561.71	.06
35	2 JAN 0130	16.47	18.68	12.05	34.25	564.36	.06
36	2 JAN 0215	16.99	16.59	11.99	32.75	566.44	.06
37	2 JAN 0300	17.18	17.09	12.01	33.34	568.49	.06
38	2 JAN 0345	10.83	13.93	11.91	24.18	570.27	.03

39	2	JAN	0430	9.05	9.85	11.79	18.40	571.59	.03
40	2	JAN	0515	8.69	8.85	11.76	17.07	572.69	.03
41	2	JAN	0600	8.62	8.65	11.75	16.81	573.74	.03
42	2	JAN	0645	10.07	9.36	11.78	18.89	574.85	.04
43	2	JAN	0730	10.48	10.29	11.81	20.20	576.06	.04
44	2	JAN	0815	10.55	10.52	11.81	20.50	577.32	.04
45	2	JAN	0900	10.57	10.56	11.81	20.56	578.59	.04
46	2	JAN	0945	10.57	10.57	11.81	20.57	579.87	.04
47	2	JAN	1030	10.57	10.57	11.81	20.57	581.14	.04
48	2	JAN	1115	10.57	10.57	11.81	20.57	582.42	.04
49	2	JAN	1200	10.57	10.57	11.81	20.57	583.69	.04
50	2	JAN	1245	10.57	10.57	11.81	20.57	584.97	.04

TABLE 1		STATION		LKJ	POND5	POND5	GFE	POND6	K
(CONT.)				FLOW	FLOW	STORAGE	FLOW	STORAGE	RAIN

PER	DAY	MON	HRMN	LKJ	POND5	POND5	GFE	POND6	K
				FLOW	FLOW	STORAGE	FLOW	STORAGE	RAIN
51	2	JAN	1330	10.57	10.57	11.81	20.57	586.24	.04
52	2	JAN	1415	10.57	10.57	11.81	20.57	587.52	.04
53	2	JAN	1500	10.57	10.57	11.81	20.57	588.79	.04
54	2	JAN	1545	6.65	8.57	11.75	14.85	589.89	.02
55	2	JAN	1630	5.55	6.04	11.68	11.29	590.70	.02
56	2	JAN	1715	5.11	5.42	11.66	10.46	591.37	.02
57	2	JAN	1800	5.29	5.31	11.66	10.30	592.02	.02
58	2	JAN	1845	5.29	5.29	11.66	10.28	592.65	.02
59	2	JAN	1930	5.29	5.29	11.66	10.29	593.29	.02
60	2	JAN	2015	5.29	5.29	11.66	10.29	593.93	.02
61	2	JAN	2100	5.29	5.29	11.66	10.29	594.57	.02
62	2	JAN	2145	5.29	5.29	11.66	10.29	595.20	.02
63	2	JAN	2230	5.29	5.29	11.66	10.29	595.84	.02
64	2	JAN	2315	5.29	5.29	11.66	10.29	596.48	.02
65	3	JAN	0000	5.29	5.29	11.66	10.29	597.12	.02
66	3	JAN	0045	5.29	5.29	11.66	10.29	597.76	.02
67	3	JAN	0130	5.29	5.29	11.66	10.29	598.39	.02
68	3	JAN	0215	5.29	5.29	11.66	10.29	599.03	.02
69	3	JAN	0300	5.29	5.29	11.66	10.29	599.67	.02
70	3	JAN	0345	5.29	5.29	11.66	10.29	600.31	.02
71	3	JAN	0430	5.29	5.29	11.66	10.29	600.94	.02
72	3	JAN	0515	5.29	5.29	11.66	10.29	601.58	.02
73	3	JAN	0600	5.29	5.29	11.66	10.29	602.22	.02
74	3	JAN	0645	5.29	5.29	11.66	10.29	602.86	.02
75	3	JAN	0730	5.29	5.29	11.66	10.29	603.49	.02
76	3	JAN	0815	5.29	5.29	11.66	10.29	604.13	.02
77	3	JAN	0900	5.29	5.29	11.66	10.29	604.77	.02
78	3	JAN	0945	5.29	5.29	11.66	10.29	605.41	.02
79	3	JAN	1030	5.29	5.29	11.66	10.29	606.04	.02
80	3	JAN	1115	5.29	5.29	11.66	10.29	606.68	.02
81	3	JAN	1200	5.29	5.29	11.66	10.29	607.32	.02
82	3	JAN	1245	5.29	5.29	11.66	10.29	607.96	.02
83	3	JAN	1330	5.29	5.29	11.66	10.29	608.59	.02
84	3	JAN	1415	5.29	5.29	11.66	10.29	609.23	.02
85	3	JAN	1500	5.29	5.29	11.66	10.29	609.87	.02
86	3	JAN	1545	5.29	5.29	11.66	10.29	610.51	.02
87	3	JAN	1630	5.29	5.29	11.66	10.29	611.14	.02
88	3	JAN	1715	5.29	5.29	11.66	10.29	611.78	.02
89	3	JAN	1800	5.29	5.29	11.66	10.29	612.42	.02
90	3	JAN	1845	5.29	5.29	11.66	10.29	613.06	.02
91	3	JAN	1930	5.29	5.29	11.66	10.29	613.69	.02
92	3	JAN	2015	5.29	5.29	11.66	10.29	614.33	.02
93	3	JAN	2100	5.29	5.29	11.66	10.29	614.97	.02
94	3	JAN	2145	5.29	5.29	11.66	10.29	615.61	.02
95	3	JAN	2230	5.29	5.29	11.66	10.29	616.25	.02
96	3	JAN	2315	5.29	5.29	11.66	10.29	616.88	.02
97	4	JAN	0000	5.29	5.29	11.66	10.29	617.52	.02
98	4	JAN	0045	5.29	5.29	11.66	10.29	618.16	.02
99	4	JAN	0130	5.29	5.29	11.66	10.29	618.80	.02
100	4	JAN	0215	5.29	5.29	11.66	10.29	619.43	.02

TABLE 1		STATION		LKJ	POND5	POND5	GFE	POND6	K
(CONT.)				FLOW	FLOW	STORAGE	FLOW	STORAGE	RAIN

PER	DAY	MON	HRMN	LKJ	POND5	POND5	GFE	POND6	K
				FLOW	FLOW	STORAGE	FLOW	STORAGE	RAIN
101	4	JAN	0300	5.29	5.29	11.66	10.29	620.07	.02
102	4	JAN	0345	1.36	1.28	11.60	4.57	620.53	.00
103	4	JAN	0430	.26	.76	11.52	1.00	620.70	.00
104	4	JAN	0515	.04	.14	11.50	.18	620.74	.00
105	4	JAN	0600	.00	.02	11.50	.02	620.75	.00
106	4	JAN	0645	.00	.00	11.50	.00	620.75	.00
107	4	JAN	0730	.00	.00	11.50	.00	620.75	.00
108	4	JAN	0815	.00	.00	11.50	.00	620.75	.00
109	4	JAN	0900	.00	.00	11.50	.00	620.75	.00
110	4	JAN	0945	.00	.00	11.50	.00	620.75	.00
111	4	JAN	1030	.00	.00	11.50	.00	620.75	.00
112	4	JAN	1115	.00	.00	11.50	.00	620.75	.00
113	4	JAN	1200	.00	.00	11.50	.00	620.75	.00
114	4	JAN	1245	.00	.00	11.50	.00	620.75	.00
115	4	JAN	1330	.00	.00	11.50	.00	620.75	.00
116	4	JAN	1415	.00	.00	11.50	.00	620.75	.00
117	4	JAN	1500	.00	.00	11.50	.00	620.75	.00
118	4	JAN	1545	.00	.00	11.50	.00	620.75	.00
119	4	JAN	1630	.00	.00	11.50	.00	620.75	.00
120	4	JAN	1715	.00	.00	11.50	.00	620.75	.00
121	4	JAN	1800	.00	.00	11.50	.00	620.75	.00
122	4	JAN	1845	.00	.00	11.50	.00	620.75	.00
123	4	JAN	1930	.00	.00	11.50	.00	620.75	.00
124	4	JAN	2015	.00	.00	11.50	.00	620.75	.00
125	4	JAN	2100	.00	.00	11.50	.00	620.75	.00
126	4	JAN	2145	.00	.00	11.50	.00	620.75	.00
127	4	JAN	2230	.00	.00	11.50	.00	620.75	.00
128	4	JAN	2315	.00	.00	11.50	.00	620.75	.00
129	5	JAN	0000	.00	.00	11.50	.00	620.75	.00
130	5	JAN	0045	.00	.00	11.50	.00	620.75	.00
131	5	JAN	0130	.00	.00	11.50	.00	620.75	.00
132	5	JAN	0215	.00	.00	11.50	.00	620.75	.00
133	5	JAN	0300	.00	.00	11.50	.00	620.75	.00
134	5	JAN	0345	.00	.00	11.50	.00	620.75	.00

135	5 JAN	0430	.00	.00	11.50	.00	620.75	.00
136	5 JAN	0515	.00	.00	11.50	.00	620.75	.00
137	5 JAN	0600	.00	.00	11.50	.00	620.75	.00
138	5 JAN	0645	.00	.00	11.50	.00	620.75	.00
139	5 JAN	0730	.00	.00	11.50	.00	620.75	.00
140	5 JAN	0815	.00	.00	11.50	.00	620.75	.00
141	5 JAN	0900	.00	.00	11.50	.00	620.75	.00
142	5 JAN	0945	.00	.00	11.50	.00	620.75	.00
143	5 JAN	1030	.00	.00	11.50	.00	620.75	.00
144	5 JAN	1115	.00	.00	11.50	.00	620.75	.00
145	5 JAN	1200	.00	.00	11.50	.00	620.75	.00
146	5 JAN	1245	.00	.00	11.50	.00	620.75	.00
147	5 JAN	1330	.00	.00	11.50	.00	620.75	.00
148	5 JAN	1415	.00	.00	11.50	.00	620.75	.00
149	5 JAN	1500	.00	.00	11.50	.00	620.75	.00
150	5 JAN	1545	.00	.00	11.50	.00	620.75	.00

TABLE 1
(CONT.)

PER	DAY	MON	HRMN	LKJ FLOW	PONDS FLOW	PONDS STORAGE	GPE FLOW	POND6 STORAGE	K RAIN
151	5	JAN	1630	.00	.00	11.50	.00	620.75	.00
152	5	JAN	1715	.00	.00	11.50	.00	620.75	.00
153	5	JAN	1800	.00	.00	11.50	.00	620.75	.00
154	5	JAN	1845	.00	.00	11.50	.00	620.75	.00
155	5	JAN	1930	.00	.00	11.50	.00	620.75	.00
156	5	JAN	2015	.00	.00	11.50	.00	620.75	.00
157	5	JAN	2100	.00	.00	11.50	.00	620.75	.00
158	5	JAN	2145	.00	.00	11.50	.00	620.75	.00
159	5	JAN	2230	.00	.00	11.50	.00	620.75	.00
160	5	JAN	2315	.00	.00	11.50	.00	620.75	.00
161	6	JAN	0000	.00	.00	11.50	.00	620.75	.00
162	6	JAN	0045	.00	.00	11.50	.00	620.75	.00
163	6	JAN	0130	.00	.00	11.50	.00	620.75	.00
164	6	JAN	0215	.00	.00	11.50	.00	620.75	.00
165	6	JAN	0300	.00	.00	11.50	.00	620.75	.00
166	6	JAN	0345	.00	.00	11.50	.00	620.75	.00
167	6	JAN	0430	.00	.00	11.50	.00	620.75	.00
168	6	JAN	0515	.00	.00	11.50	.00	620.75	.00
169	6	JAN	0600	.00	.00	11.50	.00	620.75	.00
170	6	JAN	0645	.00	.00	11.50	.00	620.75	.00
171	6	JAN	0730	.00	.00	11.50	.00	620.75	.00
172	6	JAN	0815	.00	.00	11.50	.00	620.75	.00
173	6	JAN	0900	.00	.00	11.50	.00	620.75	.00
174	6	JAN	0945	.00	.00	11.50	.00	620.75	.00
175	6	JAN	1030	.00	.00	11.50	.00	620.75	.00
176	6	JAN	1115	.00	.00	11.50	.00	620.75	.00
177	6	JAN	1200	.00	.00	11.50	.00	620.75	.00
178	6	JAN	1245	.00	.00	11.50	.00	620.75	.00
179	6	JAN	1330	.00	.00	11.50	.00	620.75	.00
180	6	JAN	1415	.00	.00	11.50	.00	620.75	.00
181	6	JAN	1500	.00	.00	11.50	.00	620.75	.00
182	6	JAN	1545	.00	.00	11.50	.00	620.75	.00
183	6	JAN	1630	.00	.00	11.50	.00	620.75	.00
184	6	JAN	1715	.00	.00	11.50	.00	620.75	.00
185	6	JAN	1800	.00	.00	11.50	.00	620.75	.00
186	6	JAN	1845	.00	.00	11.50	.00	620.75	.00
187	6	JAN	1930	.00	.00	11.50	.00	620.75	.00
188	6	JAN	2015	.00	.00	11.50	.00	620.75	.00
189	6	JAN	2100	.00	.00	11.50	.00	620.75	.00
190	6	JAN	2145	.00	.00	11.50	.00	620.75	.00
191	6	JAN	2230	.00	.00	11.50	.00	620.75	.00
192	6	JAN	2315	.00	.00	11.50	.00	620.75	.00
193	7	JAN	0000	.00	.00	11.50	.00	620.75	.00
194	7	JAN	0045	.00	.00	11.50	.00	620.75	.00
195	7	JAN	0130	.00	.00	11.50	.00	620.75	.00
196	7	JAN	0215	.00	.00	11.50	.00	620.75	.00
197	7	JAN	0300	.00	.00	11.50	.00	620.75	.00
198	7	JAN	0345	.00	.00	11.50	.00	620.75	.00
199	7	JAN	0430	.00	.00	11.50	.00	620.75	.00
200	7	JAN	0515	.00	.00	11.50	.00	620.75	.00

TABLE 1
(CONT.)

PER	DAY	MON	HRMN	LKJ FLOW	PONDS FLOW	PONDS STORAGE	GPE FLOW	POND6 STORAGE	K RAIN
201	7	JAN	0600	.00	.00	11.50	.00	620.75	.00
202	7	JAN	0645	.00	.00	11.50	.00	620.75	.00
203	7	JAN	0730	.00	.00	11.50	.00	620.75	.00
204	7	JAN	0815	.00	.00	11.50	.00	620.75	.00
205	7	JAN	0900	.00	.00	11.50	.00	620.75	.00
206	7	JAN	0945	.00	.00	11.50	.00	620.75	.00
207	7	JAN	1030	.00	.00	11.50	.00	620.75	.00
208	7	JAN	1115	.00	.00	11.50	.00	620.75	.00
209	7	JAN	1200	.00	.00	11.50	.00	620.75	.00
210	7	JAN	1245	.00	.00	11.50	.00	620.75	.00
211	7	JAN	1330	.00	.00	11.50	.00	620.75	.00
212	7	JAN	1415	.00	.00	11.50	.00	620.75	.00
213	7	JAN	1500	.00	.00	11.50	.00	620.75	.00
214	7	JAN	1545	.00	.00	11.50	.00	620.75	.00
215	7	JAN	1630	.00	.00	11.50	.00	620.75	.00
216	7	JAN	1715	.00	.00	11.50	.00	620.75	.00
217	7	JAN	1800	.00	.00	11.50	.00	620.75	.00
218	7	JAN	1845	.00	.00	11.50	.00	620.75	.00
219	7	JAN	1930	.00	.00	11.50	.00	620.75	.00
220	7	JAN	2015	.00	.00	11.50	.00	620.75	.00
221	7	JAN	2100	.00	.00	11.50	.00	620.75	.00
222	7	JAN	2145	.00	.00	11.50	.00	620.75	.00
223	7	JAN	2230	.00	.00	11.50	.00	620.75	.00
224	7	JAN	2315	.00	.00	11.50	.00	620.75	.00
225	8	JAN	0000	.00	.00	11.50	.00	620.75	.00
226	8	JAN	0045	.00	.00	11.50	.00	620.75	.00
227	8	JAN	0130	.00	.00	11.50	.00	620.75	.00
228	8	JAN	0215	.00	.00	11.50	.00	620.75	.00
229	8	JAN	0300	.00	.00	11.50	.00	620.75	.00
230	8	JAN	0345	.00	.00	11.50	.00	620.75	.00

21

231	8	JAN	0430	.00	.00	11.50	.00	620.75	.00
232	8	JAN	0515	.00	.00	11.50	.00	620.75	.00
233	8	JAN	0600	.00	.00	11.50	.00	620.75	.00
234	8	JAN	0645	.00	.00	11.50	.00	620.75	.00
235	8	JAN	0730	.00	.00	11.50	.00	620.75	.00
236	8	JAN	0815	.00	.00	11.50	.00	620.75	.00
237	8	JAN	0900	.00	.00	11.50	.00	620.75	.00
238	8	JAN	0945	.00	.00	11.50	.00	620.75	.00
239	8	JAN	1030	.00	.00	11.50	.00	620.75	.00
240	8	JAN	1115	.00	.00	11.50	.00	620.75	.00
241	8	JAN	1200	.00	.00	11.50	.00	620.75	.00
242	8	JAN	1245	.00	.00	11.50	.00	620.75	.00
243	8	JAN	1330	.00	.00	11.50	.00	620.75	.00
244	8	JAN	1415	.00	.00	11.50	.00	620.75	.00
245	8	JAN	1500	.00	.00	11.50	.00	620.75	.00
246	8	JAN	1545	.00	.00	11.50	.00	620.75	.00
247	8	JAN	1630	.00	.00	11.50	.00	620.75	.00
248	8	JAN	1715	.00	.00	11.50	.00	620.75	.00
249	8	JAN	1800	.00	.00	11.50	.00	620.75	.00
250	8	JAN	1845	.00	.00	11.50	.00	620.75	.00

TABLE 1
(CONT.)

PER	DAY	MON	HRMN	LKJ FLOW	POND5 FLOW	POND5 STORAGE	GFE FLOW	POND6 STORAGE	K RAIN
251	8	JAN	1930	.00	.00	11.50	.00	620.75	.00
252	8	JAN	2015	.00	.00	11.50	.00	620.75	.00
253	8	JAN	2100	.00	.00	11.50	.00	620.75	.00
254	8	JAN	2145	.00	.00	11.50	.00	620.75	.00
255	8	JAN	2230	.00	.00	11.50	.00	620.75	.00
256	8	JAN	2315	.00	.00	11.50	.00	620.75	.00
257	9	JAN	0000	.00	.00	11.50	.00	620.75	.00
258	9	JAN	0045	.00	.00	11.50	.00	620.75	.00
259	9	JAN	0130	.00	.00	11.50	.00	620.75	.00
260	9	JAN	0215	.00	.00	11.50	.00	620.75	.00
261	9	JAN	0300	.00	.00	11.50	.00	620.75	.00
262	9	JAN	0345	.00	.00	11.50	.00	620.75	.00
263	9	JAN	0430	.00	.00	11.50	.00	620.75	.00
264	9	JAN	0515	.00	.00	11.50	.00	620.75	.00
265	9	JAN	0600	.00	.00	11.50	.00	620.75	.00
266	9	JAN	0645	.00	.00	11.50	.00	620.75	.00
267	9	JAN	0730	.00	.00	11.50	.00	620.75	.00
268	9	JAN	0815	.00	.00	11.50	.00	620.75	.00
269	9	JAN	0900	.00	.00	11.50	.00	620.75	.00
270	9	JAN	0945	.00	.00	11.50	.00	620.75	.00
271	9	JAN	1030	.00	.00	11.50	.00	620.75	.00
272	9	JAN	1115	.00	.00	11.50	.00	620.75	.00
273	9	JAN	1200	.00	.00	11.50	.00	620.75	.00
274	9	JAN	1245	.00	.00	11.50	.00	620.75	.00
275	9	JAN	1330	.00	.00	11.50	.00	620.75	.00
276	9	JAN	1415	.00	.00	11.50	.00	620.75	.00
277	9	JAN	1500	.00	.00	11.50	.00	620.75	.00
278	9	JAN	1545	.00	.00	11.50	.00	620.75	.00
279	9	JAN	1630	.00	.00	11.50	.00	620.75	.00
280	9	JAN	1715	.00	.00	11.50	.00	620.75	.00
281	9	JAN	1800	.00	.00	11.50	.00	620.75	.00
282	9	JAN	1845	.00	.00	11.50	.00	620.75	.00
283	9	JAN	1930	.00	.00	11.50	.00	620.75	.00
284	9	JAN	2015	.00	.00	11.50	.00	620.75	.00
285	9	JAN	2100	.00	.00	11.50	.00	620.75	.00
286	9	JAN	2145	.00	.00	11.50	.00	620.75	.00
287	9	JAN	2230	.00	.00	11.50	.00	620.75	.00
288	9	JAN	2315	.00	.00	11.50	.00	620.75	.00
289	10	JAN	0000	.00	.00	11.50	.00	620.75	.00
290	10	JAN	0045	.00	.00	11.50	.00	620.75	.00
291	10	JAN	0130	.00	.00	11.50	.00	620.75	.00
292	10	JAN	0215	.00	.00	11.50	.00	620.75	.00
293	10	JAN	0300	.00	.00	11.50	.00	620.75	.00
294	10	JAN	0345	.00	.00	11.50	.00	620.75	.00
295	10	JAN	0430	.00	.00	11.50	.00	620.75	.00
296	10	JAN	0515	.00	.00	11.50	.00	620.75	.00
297	10	JAN	0600	.00	.00	11.50	.00	620.75	.00
298	10	JAN	0645	.00	.00	11.50	.00	620.75	.00
299	10	JAN	0730	.00	.00	11.50	.00	620.75	.00
300	10	JAN	0815	.00	.00	11.50	.00	620.75	.00
			MAX	992.65	755.58	28.59	1650.88	620.75	4.54
			MIN	.00	.00	.00	.00	276.90	.00
			AVE	9.69	9.07	11.01	18.49	581.53	.04

*** NORMAL END OF HEC-1 ***

Peak flow
out of Pond 5

Peak Storage
Volume Regd.
in Pond 6

* See Note on
page 9 of calculation

Hydrologic Characteristics Fly Ash Ponds APS Four Corners

A	B	C	D	E	F	G	H	I	J	K
Subbasin	Description	Disturbed/ Natural	(sq. ft.)	(sq. mi.)	(acres)	(ft)	(ft)	(ft/ft)	(minutes)	Lag time ^{1,2} (hours)
1										
2										
3	North of ash ponds	Natural	4,007,508	0.144	92	N/A	N/A	N/A	N/A	N/A
4	North of ash ponds	Natural	1,396,095	0.050	32	N/A	N/A	N/A	N/A	N/A
5	North of ash ponds	Natural	13,499,229	0.484	310	N/A	N/A	N/A	N/A	N/A
6	Contained against Ash Pond 6	Disturbed	717,777	0.026	16	N/A	N/A	N/A	N/A	N/A
7	Fly Ash Pond 6	Disturbed	6,135,370	0.220	141	N/A	N/A	N/A	N/A	0.25
8	Tributary to E	Disturbed	1,641,701	0.059	38	2000	125	0.0625	7.9	0.17
9	F1	Disturbed	1,223,826	0.044	28					
10	Potential diversion	Natural	417,875	0.015	10					
11	Tributary to E	Disturbed	749,842	0.027	17	1600	95	0.05938	6.8	0.17
12	Lined decant water pond area	Disturbed	2,083,886	0.075	48	N/A	N/A	N/A	N/A	0.25
13	Proposed lined ash pond	Disturbed	3,094,805	0.111	71	N/A	N/A	N/A	N/A	0.25
14	Fly Ash Pond 5	Disturbed	1,453,634	0.052	33	N/A	N/A	N/A	N/A	0.25
15	Tributary to J	Disturbed	2,872,885	0.103	66	1900	85	0.04474	8.6	0.17
16	Tributary to J	Natural	4,714,351	0.169	108	2500	85	0.034	11.9	0.17
17	L1	Disturbed	1,631,830	0.059	37					
18	Potential diversion	Natural	2,077,142	0.075	48					
19	Potential diversion	Natural	1,005,378	0.036	23					
20	Contained against Ash Pond 4	Disturbed	506,855	0.018	12	N/A	N/A	N/A	N/A	N/A
21	M1	Disturbed	474,272	0.017	11					
22	M2	Natural	32,583	0.001	1					
23	Contained against Ash Pond 4	Disturbed	25,975	0.001	1	N/A	N/A	N/A	N/A	N/A
24	Contained against Ash Pond 4	Disturbed	285,139	0.010	7	N/A	N/A	N/A	N/A	N/A
25	North of decant water pond	Disturbed	932,902	0.033	21					
26	East of decant water pond	Disturbed	749,317	0.027	17					
27										
28										
29	Notes:									
30	1 - If the calculation lag time is less than 10 minutes, use 10 minutes in the HEC-1 model.									
31	2 - Lag times for the fly ash ponds were assumed to be 15 minutes.									
32	HEC-1									
33	Runoff volume only									
34	Runoff volume only									
35	HEC-1									

Hydrologic Characteristics Fly Ash Ponds APS Four Corners

A	B	C	D	E	F	G	H	I
Subbasin	Description	Disturbed/ Natural	(sq. ft.)	Area (sq. mi.)	(acres)	Drainage length (ft)	Change in elevation (ft)	Average slope (ft/ft)
1								
2								
3	North of ash ponds	Natural	4007507.82	=D3/(5280*5280)	=D3/43560	N/A	N/A	N/A
4	North of ash ponds	Natural	1396005.21	=D4/(5280*5280)	=D4/43560	N/A	N/A	N/A
5	North of ash ponds	Natural	13499229.14	=D5/(5280*5280)	=D5/43560	N/A	N/A	N/A
6	Contained against Ash Pond 6	Disturbed	71777.31	=D6/(5280*5280)	=D6/43560	N/A	N/A	N/A
7	Fly Ash Pond 6	Disturbed	6135370	=D7/(5280*5280)	=D7/43560	N/A	N/A	N/A
8	Tributary to E	Disturbed	1641700.64	=D8/(5280*5280)	=D8/43560	2000	125	=H8/G8
9	F1	Disturbed	=D8-D10	=D9/(5280*5280)	=D9/43560			
10	Potential diversion	Natural	417874.69	=D10/(5280*5280)	=D10/43560			
11	Tributary to E	Disturbed	749942.09	=D11/(5280*5280)	=D11/43560	1600	95	=H11/G11
12	Lined decant water pond area	Disturbed	2083885.81	=D12/(5280*5280)	=D12/43560	N/A	N/A	N/A
13	Proposed lined ash pond	Disturbed	3094804.86	=D13/(5280*5280)	=D13/43560	N/A	N/A	N/A
14	Fly Ash Pond 5	Disturbed	1453633.81	=D14/(5280*5280)	=D14/43560	N/A	N/A	N/A
15	Tributary to J	Disturbed	2872884.76	=D15/(5280*5280)	=D15/43560	1900	85	=H15/G15
16	Tributary to J	Natural	4714350.97	=D16/(5280*5280)	=D16/43560	2500	85	=H16/G16
17	L1	Disturbed	=D16-D18-D19	=D17/(5280*5280)	=D17/43560			
18	L2	Natural	2077142.36	=D18/(5280*5280)	=D18/43560			
19	L3	Natural	1005378.29	=D19/(5280*5280)	=D19/43560			
20	Contained against Ash Pond 4	Disturbed	506854.63	=D20/(5280*5280)	=D20/43560	N/A	N/A	N/A
21	M1	Disturbed	474271.55	=D21/(5280*5280)	=D21/43560			
22	M2	Natural	32583.08	=D22/(5280*5280)	=D22/43560			
23	Contained against Ash Pond 4	Disturbed	25974.78	=D23/(5280*5280)	=D23/43560	N/A	N/A	N/A
24	Contained against Ash Pond 4	Disturbed	285138.51	=D24/(5280*5280)	=D24/43560	N/A	N/A	N/A
25	North of decant water pond	Disturbed	932902.01	=D25/(5280*5280)	=D25/43560			
26	East of decant water pond	Disturbed	749316.95	=D26/(5280*5280)	=D26/43560			
27								
28								
29	Notes:							
30	1 - If the calc							
31	2 - Lag times							
32	HEC-1							
33	Runoff volume only							
34	Runoff volume only							
35	HEC-1							

23

Hydrologic Characteristics
Fly Ash Ponds
APS Four Corners

	A	J	K
1	Subbasin	Time of concentration (minutes)	Lag time ^{1,2} (hours)
2			
3	A	N/A	N/A
4	B	N/A	N/A
5	C	N/A	N/A
6	D	N/A	N/A
7	E	N/A	= 15/60
8	F	= 0.0078 * (G8^0.77) * (I8^0.385)	= IF (0.6 * J8/60 < 10/60, 10/60, 0.6 * J8/60)
9	F1		
10	F2		
11	G	= 0.0078 * (G11^0.77) * (I11^0.385)	= IF (0.6 * J11/60 < 10/60, 10/60, 0.6 * J11/60)
12	H	N/A	= 15/60
13	I	N/A	= 15/60
14	J	N/A	= 15/60
15	K	= 0.0078 * (G15^0.77) * (I15^0.385)	= IF (0.6 * J15/60 < 10/60, 10/60, 0.6 * J15/60)
16	L	= 0.0078 * (G16^0.77) * (I16^0.385)	= IF (0.6 * J16/60 < 10/60, 10/60, 0.6 * J16/60)
17	L1		
18	L2		
19	L3		
20	M	N/A	N/A
21	M1		
22	M2		
23	N	N/A	N/A
24	O	N/A	N/A
25	P		
26	Q		
27			
28			
29	Notes:		
30	1 - If the calc		
31	2 - Lag times		
32			
33			
34			
35			

Kirpich Formula
 $T_c = 0.0078 L^{0.77} S^{-0.385}$
 Column G Column I

3.3.1.4.2 TIME OF CONCENTRATION BY THE KIRPICH FORMULA

This method is used to calculate time of concentration in gullied watersheds when using the Rational Method or the Simplified Peak Flow Method. The Kirpich Formula should be used when gullying is evident in more than 10% of the primary watercourse. Gullying can be assumed if a blue line appears on the watercourse shown on the USGS quadrangle topographic map. The Kirpich Formula is given as:

$$T_c = 0.0078 L^{0.77} S^{-0.385} \tag{3-18}$$

where

- T_c = time of concentration, in minutes
- L = length from drainage to outlet along the primary drainage path, in feet
- S = average slope of the primary drainage path, in ft./ft.

The Kirpich Formula should generally be used for the entire drainage basin. The exception to this rule occurs when the Simplified Peak Flow Method is being used on NMSHTD projects and the watercourse has a mixture of gullied and un-gullied sections. In these situations, mixing of time of concentration methods is allowed. The Upland Method is used for the ungullied portion of the primary watercourse, and the Kirpich Formula is used for the gullied portion of the watercourse. The two times of concentration are added together to obtain the total time of concentration of the watershed. Typically the Kirpich Formula is only used for that portion of the watercourse shown in blue on the quadrangle topo map. Mixing of time of concentration methods is only allowed with the Simplified Peak Flow Method for NMSHTD projects.

3.3.1.4.3 THE STREAM HYDRAULIC METHOD

The stream hydraulic method is used when calculating peak flows by the Unit Hydrograph Method in a watercourse where a defined stream channel is evident (blue line, solid or broken, on a quadrangle topo map). The designer must measure or estimate the hydraulic properties of the stream channel, and must divide the total watercourse into channel reaches which are hydraulically similar. Field reconnaissance measurements of the stream channel are best, however sometimes direct measurements are not possible. The designer must determine the slope, channel cross section and an appropriate hydraulic roughness coefficient for each channel reach. Average slope is often determined from the topographic mapping of the watershed. Channel cross section should be measured in the field whenever possible. Roughness coefficients of the waterway should be based on actual observations of the watercourse or of nearby watercourses which are believed to be similar and which are more accessible.

Time of Concentration by the stream hydraulic method is simply the travel time in the stream channel. Channel flow velocities can be estimated from normal depth calculations for the watercourse. In addition to the average flow velocity, designers should compute the Froude Number of the flow. If the Froude number of the flow exceeds a value of 1.3, then the designer should verify that supercritical flow conditions can actually be sustained. For most earth lined channels the velocity calculation should be recomputed using a larger effective

Infiltration That part of the rainfall that enters the soil. The passage of water through the soil surface into the ground. Used interchangeably herein with the word: percolation.

Infiltration Rate The rate at which water enters the soil under a given condition. The rate is usually expressed in inches or centimeters per hour, or feet per day.

Initial Abstraction (Ia) When considering surface runoff, Ia is all the rainfall before runoff begins. When considering direct runoff, Ia consists of interception, evaporation, and the soil-water storage that must be exhausted before direct runoff may begin. Sometimes called "initial loss."

Intensity The rate of rainfall upon a watershed, usually expressed in inches per hour.

Interception Precipitation retained on plant or plant residue surfaces and finally absorbed, evaporated, or sublimated. That which flows down the plant to the ground is called "stemflow" and not counted as true interception.

Isohyet A line on a map, connecting points of equal rainfall amounts.

Lag Time, T_L The difference in time between the centroid of the excess rainfall (that rainfall producing runoff) and the peak of the runoff hydrograph. Often estimated as 60 percent of the time of concentration ($T_L = 0.6T_c$).

Land Use A land classification. Cover, such as row crops or pasture, indicates a kind of land use. Roads may also be classified as a separate land use.

Length A certain distance within a watershed or along a water course. For Time of Concentration computation, length is defined as the distance from the drainage divide to the point of interest, following primary flow paths.

Levee A linear embankment outside a channel for containment of flow.

Major Structure A drainage conduit which is larger than a minor structure, yet smaller than a bridge.

Manning's "n" A coefficient of roughness, used in a formula for estimating the capacity of a channel to convey water. Generally, values are determined by inspection of the channel.

Mass Inflow Curve A graph showing the total cumulative volume of stormwater runoff plotted against time for a given drainage area.

Minor Structure A drainage conduit which is equal to or greater than a 48" (1.6 M) circular pipe culvert, or equivalent hydraulic capacity.

DRAINAGE DESIGN CRITERIA

FOR

**NEW MEXICO STATE HIGHWAY &
TRANSPORTATION DEPARTMENT
PROJECTS**

REVISED DATE:

November, 1998

Approved for
Implementation:

Pat K. Rahn

NMSHTD
SECRETARY

12-16-98

Date

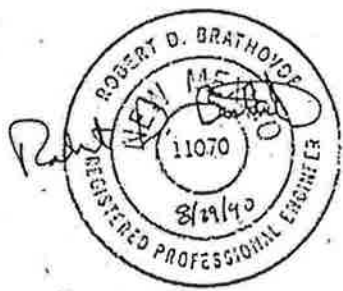

REPORT
RAISING ASH DAMS 3 AND 6
FOUR CORNERS STEAM ELECTRIC STATION
FOR
ARIZONA PUBLIC SERVICE COMPANY





SPILLWAY
ELEV 5378

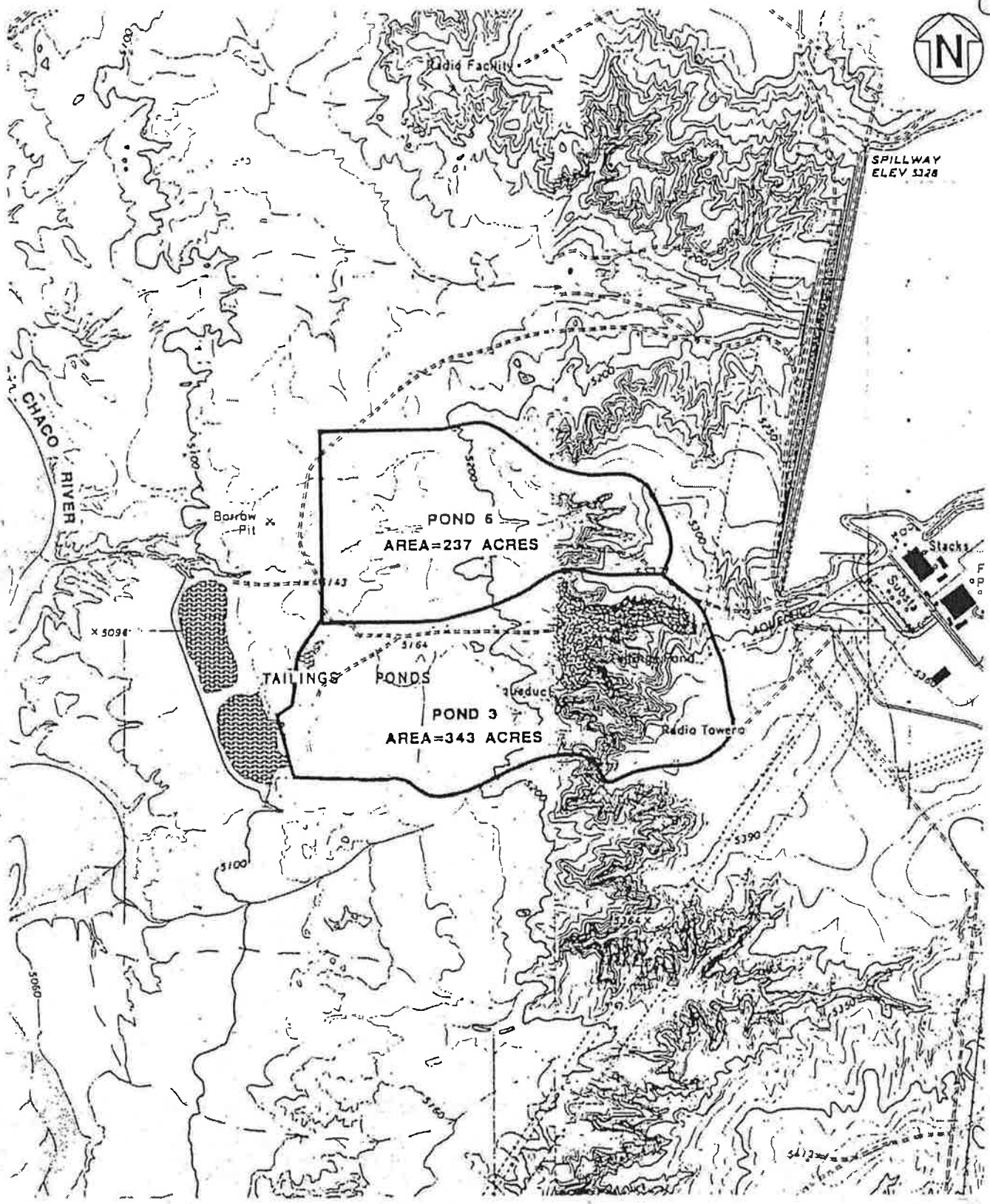

LEGEND:

— DRAINAGE AREA BOUNDARY

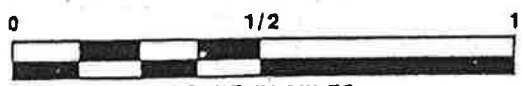

SCALE IN MILES

**DRAINAGE
AREA BOUNDRIES**

Figure 2

Dames & Moore
03353-105-022

MAP REFERENCE:

3.3.2 Ash Pond 3 Reservoir Capacity

Raising the ash dam 3 embankment from its current elevation of 5209 feet to 5219 feet can provide approximately one million cubic yards of additional storage capacity. This is presented on the capacity rating curve for ash pond 3 (Figure 4) using the minimum required operating (non-flood) freeboard of 4.6 feet. The capacity rating curve is based on the existing conditions shown on the 1989 topographic map provided by APS (APS 1989). This additional storage capacity adds between 2 and 3 years of storage, based on the fly ash production rates presented previously.

3.4 SURFACE WATER HYDROLOGY

This section presents the results of the hydrologic analysis of ash ponds 3 and 6 as authorized by the contract and described in Dames & Moore's original proposed scope of work (Dames & Moore 1989).

3.4.1 Hydrologic Design Criteria and Methodology

The hydrologic design criteria for ash ponds 3 and 6 were developed based on telephone conversations with New Mexico State Engineer Office personnel. An explanation of proposed freeboard requirements was presented to the New Mexico State Engineers Office on May 29, 1990. The June 7, 1990 response from the state concurred with Dames & Moore's recommendations. Copies of this correspondence are presented in Appendix B. The hydrologic design criteria are presented in Table 1.

TABLE 1

HYDROLOGIC DESIGN CRITERIA

Design Storm	The 24-hour portion of the Probable Maximum Precipitation Event.
Volume of Runoff from Design Storm to be Retained.	100%
Post Storm Minimum Freeboard	2.8 feet

The methodology used to complete the hydrologic analysis for ash ponds 3 and 6 was based on current accepted procedures and is outlined in the following paragraphs.

- o The hypothetical general storm depth of the probable maximum precipitation (PMP) was developed using Hydrometeorological Report No. 49 (HMR-49) (NOAA 1977). HMR-49 is the standard reference for developing PMP in the Colorado River Basin. The complete process of the PMP development is described in HMR-49.
- o Tributary basin areas for ash ponds 3 and 6 were delineated using 1-inch = 2000 feet, 20 foot contour interval, topographic maps (USGS 1966 and 1979). See Figure 2.
- o Soil conservation service (SCS) curve numbers (CNs) were selected for the basin areas based on a review of soil cover complexes occurring within the study area (SCS 1980) and based on the TR-55 (SCS 1986) suggested CNs for herbaceous cover. A weighted CN for each basin was then estimated using an area-weighted method for calculation:

$$CN = \frac{CN_i A_i \%}{100\%}$$

where, CN = Weighted sub-basin CNs
 A_i% = Percentage of total basin area represented by soils of a hydrologic group.
 CN_i = CN selected for soils for a hydrologic group (AMC II).

- o Runoff volumes occurring as a result of the 24-hour portion of the general storm PMP were estimated using methods outlined in the SCS's National Engineering Handbook Section 4, Page 10.21, Figure 10.1 (SCS 1975) for each pond.
- o Capacity rating curves for ash ponds 3 and 6 were developed for the proposed dam crest raises based on a December 14, 1989 topographic map of the ash ponds (scale 1 inch = 200 feet).
- o Ash ponds 3 and 6 were then evaluated for flood pool storage and minimum freeboard specification at increasing dam crest elevations.

3.4.2 Results

Table 2 presents the results of the hydrologic analysis pertaining to precipitation depths, estimated basin areas, weighted CNs, and estimated runoff volumes.

TABLE 2

RESULTS OF HYDROLOGIC ANALYSIS

<u>Item</u>	<u>Units</u>	<u>Ash Pond 3</u>	<u>Ash Pond 6</u>
24-Hour General Storm PMP Depth	inches	8.3	8.3
Size of Drainage Basin Area	acres	343	237
Surface Area of Ash Pond	acres	138	140
Weighted CN Value (AMC II Condition)	-	95	95
Estimated Depth of Direct Runoff	inches	7.7	7.7
Estimated Volume of Runoff to be Retained (Area x Runoff Depth)	acre-feet	220	152

Dames & Moore performed a pre-storm freeboard analysis based on the information contained in Tables 1 and 2 and using the capacity rating curves presented on Figures 4 and 5. Pre-storm freeboard has been defined for this analysis as the difference between the lowest dam crest elevation and the elevation at which all the settled fly ash in the pond would just be covered by a water surface. Figure 5 presents the minimum pre-storm freeboard requirements for ash ponds 3 and 6. The option of adding an emergency spillway to ash pond 3 appears feasible as a spillway through the left abutment would discharge to a location where flow could be safely managed to the property boundary. This emergency spillway was not evaluated in detail during the current project.

Fly Ash Pond No. 6
Volumes based on 7/19/01 topography

Elevation			Incremental storage volume cubic yards	Cumulative storage volume	
ft		ft		cubic yards	acre-feet
5212	TO	5213	47	47	0.0
5213	TO	5214	78	125	0.1
5214	TO	5215	1,169	1,294	0.8
5215	TO	5216	6,784	8,078	5.0
5216	TO	5217	35,491	43,569	27
5217	TO	5218	81,430	124,999	77
5218	TO	5219	146,783	271,782	168
5219	TO	5220	175,022	446,803	277
5220	TO	5221	189,022	635,825	394
5221	TO	5222	204,258	840,083	521
5222	TO	5223	209,979	1,050,062	651
5223	TO	5224	212,804	1,262,866	783
5224	TO	5225	212,691	1,475,557	915

Project Name:	Lined Ash Impoundment 5268 Raise	Project Number:	23445725
Project Location:	Four Corners Power Plant, NM	Client Name:	APS - Four Corners Power Plant
PM Name:	Jeff Heyman	PIC Name:	

IDENTIFYING INFORMATION

(This section is to be completed by the Originator.)

Calculation Medium: Electronic File Name: _____
 (Select as appropriate) Hard-copy Unique Identification: _____
 Number of pages
 (including cover sheet): 13

Discipline: Civil Engineering
 Title of Calculation: LDWP Wave run-up and Freeboard Analysis
 Calculation Originator: Michael S. Johnson, EIT
 Calculation Contributors:
 Calculation Checker: Nathan Ewert, EIT

DESCRIPTION & PURPOSE

The purpose of this calculation is to determine the freeboard requirements for the Lined Decant Water Pond (LDWP) at the Four Corners Power Plant in New Mexico.

BASIS / REFERENCE / ASSUMPTIONS

Based upon the New Mexico State Regulations, the design wind speed is 50 mph, slopes of LDWP are assumed to be 3:1

ISSUE / REVISION RECORD

Checker comments, if any, provided on: hard-copy electronic file Form 3-5 (MM)

No.	Description	P	S	F	Originator Initials	Date	Checker Initials	Date
0	Initial Issue	<input type="checkbox"/>	<input type="checkbox"/>	<input checked="" type="checkbox"/>	MSJ	[]	NRE	7-30-2010
1		<input type="checkbox"/>	<input type="checkbox"/>	<input type="checkbox"/>	[]	[]	[]	[]
2		<input type="checkbox"/>	<input type="checkbox"/>	<input type="checkbox"/>	[]	[]	[]	[]
3		<input type="checkbox"/>	<input type="checkbox"/>	<input type="checkbox"/>	[]	[]	[]	[]

Note: For a given Revision No. Check off either P (Preliminary), S (Superseding) or F (Final). If there are no revisions to the Initial Issue check off F (Final). Comments may be provided on the hard-copy calculations, electronic file or on Form 3-5 (MM).

APPROVAL and DISTRIBUTION

The calculations associated with this Cover Sheet have been checked.

 **MICHAEL JOHNSON**
 Originator Signature 9/30/2010
Date

 **Nathan Ewert**
 Checker Signature 10/1/10
9-30-2010
Date

 **Jeff Heyman P.E. R.G.**
 Project Manager Signature 10/6/2010
Date

Distribution:

Project Central File – Quality file folder
 Other Specify: _____

WAVE RUN-UP CALCULATION AND FREEBOARD ANALYSIS
for the LINED DECANT WATER POND
at the FOUR CORNERS POWER PLANT
ARIZONA PUBLIC SERVICE

Problem Statement

The object of this calculation is to determine the freeboard required for the Lined Decant Water Pond (LDWP) at the Four Corners Power Plant in New Mexico.

The wave action was determined using the procedure outlined in USBR's Manual ACER Technical Memorandum No.2 (1981) titled as "Freeboard Criteria and Guidelines for Computing Freeboard Allowances for Storage Dams."

Required Deliverables

- Effective Fetch Length
- Wave Run-up
- Wave Setup
- Total Freeboard

Data Available

- Lined Decant Water Pond layout, See **Figure 1**
- Minimum Water Depth = 5 ft
- Maximum Water Depth = 8 ft
- Design Wind Speed is 50 mph per New Mexico State regulations
- Lined Decant Water Pond side slopes are 3:1 H:V

Methodology

- **Fetch Length (F)**

Fetch length is the distance across water that wind blows to generate waves. In other words, fetch is the open water distance (in the direction of the wind velocity) upwind of the point in question.

The wind directions at the Four Corners Power Plant are assumed to be in the direction of the central radial for the maximum effective fetch. The effective fetch at a given station was estimated using the following, relationship as described in Equation 1 on Page 11 of USBR's Manual ACER TM No.2 (USBR, 1981):

$$F_e = \Sigma X_i * \text{Cos}\alpha_i / \Sigma \text{Cos}\alpha_i$$

Where,

F_e = Effective fetch length

α_i = Angle between the central radial and radial i

X_i = Length of projection of radial i on the central radial

The effective fetch length was found to be equal to 0.260 miles for the LDWP. All calculations related to the estimation of effective fetch lengths are provided in **Table 1** and **Figure 1**.

- **Wind Speed & Duration**

URS understands that the State of New Mexico requires the design wind speed for this site to be 50 mph. Although a wind speed of 50 mph is less than that estimated using the method detailed by ACER TM. No. 2 (USBR, 1981), it was used for this calculation.

The relationship between wind speed (over water) and wind duration for a given fetch (0.260 miles) was developed from Figure 9 of ACER TM. No. 2 (USBR, 1981) and is provided in **Table 2**.

- **Significant Wave Height (H_s)**

The significant wave height (H_s) is 1.18 ft and was obtained using Figure 9 of ACER TM. No. 2 (USBR, 1981) for an effective fetch length of 0.260 mile and a design wind speed of 50 mph.

- **Specific Wave Height (H)**

Please note that as per information provided on page 15 of ACER TM. No. 2 (USBR, 1981), for normal freeboard computations, the significant wave height should be replaced by the average of the highest 10 percent of the waves, which is 1.27 times the significant wave height. Therefore, the significant wave height (H_s) of 1.18 ft was multiplied by 1.27 to obtain the specific wave height (H) of 1.50 ft for the LDWP. All calculations related to the estimation of the specific wave height are provided in **Tables 3 through 6**.

- **Wavelength (L)**

Waves are classified as short, intermediate or long depending on their relative depth. The relative depth is defined as the reservoir depth divided by the Wave Length (h/L). Short waves are also referred to as deep-water waves. Deep-water waves are defined as having a relative depth (h/L) greater than $1/2$. Long waves are defined as having a relative depth less than $1/20$. The class of waves in between short and long are called intermediate waves.

The wavelength for deep water waves may be estimated using the relationship provided on Page 12 of ACER TM. No. 2 (USBR, 1981):

$$L = 5.12 * T^2$$

Where,

L = Wave length (ft) (when $L/2$ is \leq depth of pond)

T = Wave Time Period (sec)

The wave period, T was estimated using Figure 10 of ACER TM. No. 2 (USBR, 1981). The wave periods are shown in Tables 3 and 5.

Two water depth scenarios were explored in this calculation, 5 and 8 feet. These are both classified as intermediate waves since they do not satisfy the deep water relative depth ($h/L = 1/2$) for the above equation. For these situations, the USBR recommends adjusting the wavelength based on the relationship established between wave length, period and depth in the U.S. Army Corps of Engineers Shore Protection Manual vol. III. These relationships are further defined and updated in the U.S. Army Corps of Engineers Coastal Engineering Manual, Part II, Chapter 1 (U.S. Army Corps, 2006):

$$C = \sqrt{\frac{gL}{2\pi} \tanh \frac{2\pi d}{L}} ; \text{ and}$$

$$L = CT$$

Where,

L = Wave length (ft)

T = Wave Time Period (sec)

d = Depth of Water (ft)

g = gravitational acceleration (32.2 ft/s²)

The actual wave length is calculated through trial and error so that the value satisfies both equations.

For the purposes of this calculation, both the USBR equation and the US Army Corps equations for determining wave length were explored. It was determined that the USBR method would be conservative with regard to the calculated wave run-up and setup depths, even though the impoundment depths do not meet the relative depth criteria ($h/L = 1/2$). Therefore, the wave lengths calculated for both scenarios were 17.04 and 17.80 feet respectfully.

- **Wave Run-up (R)**

The Wave run-up (R_s) was determined using the relationship provided on page 13 of ACER TM. No. 2 (USBR, 1981). It is described as follows:

$$R_s = H / [0.4 + (H/L)^{0.5} * \cot\theta]$$

Where,

H = Specific wave height in feet

L = Wave length in feet

θ = Angle of the upstream face of the dam with horizontal

Please note that in the above equation, the significant wave height (H_s) should be used instead of specific wave height (H) if calculations are being made for the minimum freeboard. However, for the normal freeboard calculations, specific wave height (H) should be used. Please also note that the above wave run-up equation should not be used on slopes flatter than 5:1 (H: V). Also, note that for embankment dams with soil cement or other smooth upstream surfaces, the wave run-up computed by above equation should be multiplied by a factor of up to 1.5, depending on the smoothness of the surface. In example problems documented on page 13 in ACER TM. No. 2 (USBR, 1981), a factor of 1.4 was used for the soil cement and a factor of 1.0 was used for the riprap. For the LDWP at the Four Corners Power Plant, the upstream surface is lined with non-textured liner and is considered a smooth surface. Therefore, a factor of 1.5 was used for estimation of the wave run-up.

The estimated corrected wave run-ups for the 5 ft and 8 ft water depths in the LDWP were 1.78 feet and 1.80 feet for an average embankment slope of 3:1 (H: V) at the Four Corners Power Plant. However, as per the information provided on page 14 of ACER TM. No. 2 (USBR, 1981), if the wave propagation direction as defined by the central radial is not normal to the dam, a correction factor should be applied to the computed run-up. In our case, the angle between the wave propagation direction, as defined by the central radial, is assumed to be normal to the LDWP and does not need to be corrected, See **Figure 1**. All calculations related to the estimation of the wave run-up are provided in **Tables 3 through 6**.

- **Setup (S)**

When no wind is blowing, the water surface in the reservoir is horizontal. However, when the wind is blowing, a shear stress acts on the water surface. Because of this the surface will tilt, which is known as setup or wind tide. The wind setup in a reservoir was estimated using the relationship provided on Page 14 of ACER TM. No. 2 (USBR, 1981):

$$S = (U^2 F) / (1400D)$$

Where,

S = Wind Setup (ft)

U = Wind Speed (mph)

F = Fetch Length (miles), normally equals 2*F_e

D = Average Water Depth of the Reservoir (ft)

The wind setups for the 5 ft and 8 ft water depths for the LDWP were found to equal 0.19 and 0.12 ft, respectively. See Tables 3 through 6

- **Lined Decant Water Pond, Probable Maximum Flood inflow depth calculation**

The LDWP will need to contain inflow from the Lined Ash Impoundment (LAI), which is directly east of the LDWP. It is assumed that the LAI will not store water and all inflow will report directly to the LDWP. The LDWP will also need to accommodate storage for subbasin Q, which is essentially the embankment slope between both the LAI and LDWP (refer to Figure 1). The areas of the basins described were added together and multiplied by the Probably Maximum Precipitation (PMP) depth, which was based on the January 14, 2003 Freeboard Evaluation of Ash Pond 6 performed by URS Corporation for the Four Corners Power Plant (URS, 2003), and then divided by the surface area of the operating elevation of 5210 ft within the LDWP to determine the height required to store the total inflow.

Table 7

Lined Ash Impoundment (LAI)	130.5	ac
Subbasin Q	8.2	ac
Lined Decant Water Pond (LDWP)	48	ac
Total Area	186.7	ac
PMP	10.9	inches
Storage Volume required within the LDWP	169.59	ac-ft
Surface Area at elevation 5210 ft	42.7	ac
Depth required for storage in LDWP	3.97	ft

Results

The maximum operating depth of the LDWP is determined from the sum of the wave run-up and setup plus the storage depth for the PMP as calculated in Table 7. The wave run-up and setup calculated for the 5 ft and 8 ft depth are 2.0 ft and 1.9 ft, respectively (see Tables 4 and 6). The PMP storage required in the LDWP is 4.0 ft. Therefore, the maximum operating depth for the LDWP at the Four Corners Power Plant is 6.0 ft below the crest elevation of 5216.0 ft. This results in a maximum operating elevation of 5210.0 ft.

References

1. URS Corporation. *Freeboard Evaluation, Fly Ash Pond No. 6, Arizona Public Service Company, URS Job No. 23442859*. Santa Fe, New Mexico. January 14, 2003.
2. U.S. Department of the Interior, Bureau of Reclamation (USBR). *ACER Technical Memorandum No. 2, Freeboard Criteria and Guidelines for Computing Freeboard Allowances for Storage Dams*. Assistant Commissioner - Engineering and Research, Denver, Colorado. 1981.
3. Zeki Demirbilek, Ph. D. 2008. Water Wave Mechanics. Coastal Engineering Manual, Part II, Chapter II-1, EM-1110-2-1100, U.S. Army Corps of Engineers., Washington, DC.

**LINED DECANT WATER POND
WAVE RUNUP CALCULATION
IMPOUNDMENT DESIGN
FOUR CORNERS POWER PLANT
ARIZONA PUBLIC SERVICE**

1	2	3	4	5	6	7	8	9	10	11	12	13	14	15	16	17	18	19	20	21	22	23	24	25	26	27	28	A	B	C	D	E	F	G	H	I	J	K	L	M
Table 1																																								
2 Estimation of Effective Fetch Length																																								
3 Palo Verde Makeup Reservoir Impoundment																																								
4																																								
Table 2																																								
Wind Velocity and Duration																																								
5	α	Cos(α)	Fetch Length	X*Cos(α)	Wind Velocity	Fetch	Duration																																	
6	degrees		X (ft)	X (mi)	mi/hr	mi	min																																	
7	45	0.707	1,123.57	0.213	20	0.26	9.8																																	
8	40	0.766	1,211.85	0.230	30	0.26	8																																	
9	30	0.866	1,444.59	0.274	40	0.26	7.2																																	
10	20	0.940	1,711.38	0.324	50	0.26	6.5																																	
11	10	0.985	1,668.23	0.316	60	0.26	6																																	
12	0	1.000	1,651.00	0.313	70	0.26	5.7																																	
13	10	0.985	1,672.55	0.317	80	0.26	5.5																																	
14	20	0.940	1,405.61	0.266																																				
15	30	0.866	1,051.41	0.199																																				
16	40	0.766	857.42	0.162																																				
17	45	0.707	793.13	0.150																																				
18																																								
19	Σ Cos α =	9.527	Σ X*Cos α =	2.457																																				
20																																								
21																																								
22	Effective Fetch Length																																							
23	Σ X*Cos α / Σ Cos α =	0.2579		miles																																				
24																																								
25	Design Fetch =																																							
26	0.260		miles																																					
27																																								
28																																								
Notes:																																								
1- The design wind speed of 50 mph is based on New Mexico regulations																																								
3- The duration of wind is determined using Figure 9 of USBR's Manual ACER TM NO.2 (1981)																																								
3- α Angle in degrees between central radial and fetch line																																								

LINED DECANT WATER POND - FORMULAS
 WAVE RUNUP CALCULATION
 IMPOUNDMENT DESIGN
 FOUR CORNERS POWER PLANT
 ARIZONA PUBLIC SERVICE

A	B	C	D	E	F	G	H	I	J	K	L	M
1	Table 1											
2	Estimation of											
3	Palo Verde Makeup Reservoir Impoundment											
4	Wind Data											
5	α	$\text{Cos}(\alpha)$	Fetch Length		$X^* \text{Cos}(\alpha)$	Wind Velocity	Fetch	Duration				
6	degrees		X (ft)	X (mi)		mi/hr	mi	min				
7	45	=COS(RADIANS(A7))	1123.57	=C7/5280	=D7*B7	20	=E8\$25	9.8				
8	40	=COS(RADIANS(A8))	1211.85	=C8/5280	=D8*B8	30	=E9\$25	8				
9	30	=COS(RADIANS(A9))	1444.59	=C9/5280	=D9*B9	40	=E10\$25	7.2				
10	20	=COS(RADIANS(A10))	1711.38	=C10/5280	=D10*B10	50	=E11\$25	6.5				
11	10	=COS(RADIANS(A11))	1668.23	=C11/5280	=D11*B11	60	=E12\$25	6				
12	0	=COS(RADIANS(A12))	1651	=C12/5280	=D12*B12	70	=E13\$25	5.7				
13	10	=COS(RADIANS(A13))	1672.55	=C13/5280	=D13*B13	80	=E14\$25	5.5				
14	20	=COS(RADIANS(A14))	1405.61	=C14/5280	=D14*B14	Notes:						
15	30	=COS(RADIANS(A15))	1051.41	=C15/5280	=D15*B15	1- The design wind speed of 50 mph is based on New Mexico regulations						
16	40	=COS(RADIANS(A16))	857.42	=C16/5280	=D16*B16	3- The duration of wind is determined using Figure 9 of USBR's Manual ACER TM NO.2 (1981)						
17	45	=COS(RADIANS(A17))	793.13	=C17/5280	=D17*B17	3- α Angle in degrees between central radial and fetch line						
18	$\Sigma \text{Cos } \alpha$	=SUM(B7:B17)	$\Sigma X^* \text{Cos } \alpha$		=SUM(E7:E17)							
19			Effective Fetch Length									
20			$\Sigma X^* \text{Cos } \alpha / \Sigma \text{Cos } \alpha$		=E19/B19	miles						
21			Design Fetch =		=ROUNDUP(E23,2)	miles						
22												
23												
24												
25												
26												
27												
28												

LINED DECANT WATER POND
 WAVE RUNUP CALCULATION
 IMPOUNDMENT DESIGN
 FOUR CORNERS POWER PLANT
 ARIZONA PUBLIC SERVICE

A	B	C	D	E	F	G	H	I	J	K	L	M	N
1 IMPORTANT FORMULAS			CONSTANTS										
2													
3	Wave length, $L = 5.12 \cdot T^2$												
4	Required Reservoir Depth (ft) = $0.5 \cdot L$			1373 ft		0.26 miles							
5	Run-up, $R_o = H_w / [0.4 + (H_w / L)^{0.5} \cdot \cot \theta]$			5.00 ft									
6	Setup, $S = U^2 \cdot F / 1400 \cdot D$												
7	Fetch, $F = 2 \cdot F_o$				3:1 (H:V)								
8	Wave Runup + Setup = $R_c + S$												
9													
10													

Table 3

U	H _s	Wave Period, T	L	Minimum D**	H*	H*/L	R	R _c	S	Wave Runup + Setup
mi/hr	ft	seconds	ft	ft	ft		ft	ft	ft	ft
40	0.9	1.70	14.80	7.4	1.17	0.08	0.96	1.45	0.12	1.57
50	1.18	1.87	17.90	9.0	1.50	0.08	1.21	1.82	0.19	2.01
60	1.40	2.03	21.10	10.5	1.78	0.08	1.44	2.15	0.27	2.42
70	1.65	2.18	24.33	12.2	2.10	0.09	1.68	2.52	0.36	2.88
80	1.90	2.30	27.08	13.5	2.41	0.09	1.91	2.87	0.48	3.34
11										
12										
13										
14										
15										
16										
17										
18										
19	U is wind speed									
20	H _s is significant wave height, estimated from Figure 9, USBR ACER TM No. 2									
21	T, Wave Period was obtained from Figure 10 of USBR's Manual ACER TM No. 2									
22	D** minimum required reservoir depth for these relationships to apply.									
23	H* is the wave height which is only exceeded by 10% of waves, obtained by multiplying H by 1.27, USBR ACER TM No. 2									
24	R _c (corrected) is adjusted for a smooth slope surface and has been multiplied by 1.5; USBR ACER TM NO.2									
25	S is the set-up caused by wind									
26	Fe is the Effective Fetch distance									
27										

NOTE: The Depth of the reservoir is estimated to be 5 feet, the minimum required reservoir depth for the above referenced equation is 9 feet. Therefore, the wave length must be adjusted according to the US Army Corps of Engineers Coastal Engineering Manual, see attached. The wave length L is recalculated according to the Corp equation: $L = CT$, where $C = \text{SQRT}(g/2\pi \cdot \tanh(2\pi \cdot d/L))$, where d is the total depth and g is gravitational acceleration (32.2 ft/s²). Use trial and error (L-guess) to find actual L.

Table 4

U	H _s	Wave Period, T	Depth	L-guess	C	L (actual)	H	H*/L	R _c	S	Wave Runup + Setup
mi/hr	ft	seconds	ft	ft		ft	ft	ft	ft	ft	ft
50	1.18	1.87	5.00	17.044	9.115	17.044	1.50	0.088	1.78	0.19	1.96
30											
31											
32											
33											
34	* Although the reservoir does not meet criteria for a deep reservoir based upon $1/2L$, we will use the 2.00 ft wave runup and setup to be conservative.										

LINED DECANT WATER POND
 WAVE RUNUP CALCULATION
 IMPOUNDMENT DESIGN
 FOUR CORNERS POWER PLANT
 ARIZONA PUBLIC SERVICE

A	B	C	D	E	F	G	H	I	J	K	L	M	N
1	IMPORTANT FORMULAS		CONSTANTS										
2													
3	Wave length, $L = 5.12 \times T^2$												
4	Required Reservoir Depth (ft) = $0.5 \times L$			1373 ft			0.26 miles						
5	Run-up, $R_c = H_w [0.4 + (H_w/L)^{0.5} \cot \theta]$			8.00 ft									
6	Setup, $S = U^2 F / 1400 \times D$												
7	Fetch, $F = 2 \times F_e$												
8	Wave Runup + Setup = $R_c + S$												

Table 5

U	H _s	Wave Period, T	L	Minimum D**	H*	H*/L	R	R _c	S	Wave Runup + Setup
mi/hr	ft	seconds	ft	ft	ft		ft	ft	ft	ft
40	0.9	1.70	14.80	7.4	1.17	0.08	0.96	1.45	0.07	1.52
50	1.18	1.87	17.90	9.0	1.50	0.08	1.21	1.82	0.12	1.94
60	1.40	2.03	21.10	10.5	1.78	0.08	1.44	2.15	0.17	2.32
70	1.65	2.18	24.33	12.2	2.10	0.09	1.68	2.52	0.23	2.75
80	1.90	2.30	27.08	13.5	2.41	0.09	1.91	2.87	0.30	3.17

U is wind speed
 H_s is significant wave height, estimated from Figure 9, USBR ACER TM No. 2
 T, Wave Period was obtained from Figure 10 of USBR's Manual ACER TM No. 2
 D** minimum required reservoir depth for these relationships to apply.
 H* is the wave height which is only exceeded by 10% of waves, obtained by multiplying H by 1.27. USBR ACER TM No. 2
 R_c (corrected) is adjusted for a smooth slope surface and has been multiplied by 1.5. USBR ACER TM NO. 2
 S is the set-up caused by wind
 F_e is the Effective Fetch distance

NOTE: The Depth of the reservoir is estimated to be 8 feet, the minimum required reservoir depth for the above referenced equation is 9 feet. Therefore, the wave length must be adjusted according to the US Army Corps of Engineers Coastal Engineering Manual, see attached. The wave length L is recalculated according to the Corp equation: $L = CT$, where $C = \text{SQRT}(g/L/2\pi * \tanh(2\pi * d/L))$, where d is the total depth and g is gravitational acceleration (32.2 ft/s²). Use trial and error (L-guess) to find actual L.

Table 6

Linear Theory	U	H _s	Wave Period, T	Depth	L-guess	C	L (actual)	H	H*/L	R	R _c	S	Wave Runup + Setup
	mi/hr	ft	seconds	ft	ft		ft	ft	ft	ft	ft	ft	ft
	50	1.18	1.87	8.00	17.795	9.516	17.795	1.50	0.084	1.20	1.80	0.12	1.92

* Although the reservoir does not meet criteria for a deep reservoir based upon 1/2L, we will use 2.00 ft wave runup and setup to be conservative.

LINED DECANT WATER POND - FORMULAS
 WAVE RUNUP CALCULATION
 IMPOUNDMENT DESIGN
 FOUR CORNERS POWER PLANT
 ARIZONA PUBLIC SERVICE

A	B	C	D	E	F	G	H	I	J	K	L	M	N
1	IMPORTANT FORMULA												
2	CONSTANTS												
3	Wave length, L = 5.12T ²	Futch length (F _L) = 4.07*5260											
4	Required Reservoir Depth (R ₁) = 0.5L	Reservoir depth											
5	Run-up, R ₂ = H*(0.4+0.14L ^{0.0002})	Embankment slope											
6	Setup, S ₁ = 1.7*(14600/D)	Futch, F = 297											
7	Wave Runup + Setup = R ₁ + S												
8	Table 5												
9	U	H ₁	H ₂	Wave Period, T	L	Minimum D=	H [*]	R	R ₁	R ₂	S	Wave Runup + Setup	
10	mph	ft	ft	seconds	ft	ft	ft	ft	ft	ft	ft	ft	ft
11	40	2.02	1.7	16.122	45.1701372	16.122	14.27612	45.1701372	16.122	14.27612	16.122	45.1701372	
12	50	2.52	2.1	19.811	56.4626442	19.811	17.761	56.4626442	19.811	17.761	19.811	56.4626442	
13	60	3.02	2.5	24.868	69.1501492	24.868	21.761	69.1501492	24.868	21.761	24.868	69.1501492	
14	70	3.52	3.0	31.302	83.1701642	31.302	26.761	83.1701642	31.302	26.761	31.302	83.1701642	
15	80	4.02	3.5	39.122	98.1701792	39.122	32.761	98.1701792	39.122	32.761	39.122	98.1701792	
16	90	4.52	4.0	48.222	115.1701942	48.222	39.761	115.1701942	48.222	39.761	48.222	115.1701942	
17	100	5.02	4.5	58.622	134.1702092	58.622	47.761	134.1702092	58.622	47.761	58.622	134.1702092	
18	U is wind speed												
19	H ₁ is wave height, estimated from Figure 9, USBR ACEER TM No. 2												
20	H ₂ is wave height, estimated from Figure 10, USBR ACEER TM No. 2												
21	T is wave period, estimated from Figure 11, USBR ACEER TM No. 2												
22	D is minimum required reservoir depth												
23	H* is the wave height which is only exceeded by 10% of waves, obtained by multiplying H ₁ by 1.22, USBR ACEER TM No. 2												
24	R ₁ (cresting) is adjusted for a smooth slope surface and has been multiplied by 1.5, USBR ACEER TM No. 2												
25	S is the setup caused by wind												
26	F _L is the Effective Futch distance												
27	NOTE: The Depth of the reservoir is estimated to be 8 feet, the minimum required reservoir depth for the above referenced equation is 6 feet. Therefore, the wave length must be adjusted according to the US Army Corps of Engineers Coastal Engineering Manual, 4th edition. The wave length L is indicated according to the Corp equation: L = CT, where C = SQRT(g/2z * tan(2z - 6/L)), where d is the total depth and z is gravitational acceleration (32.2 ft/s ²). Use trial and error (L-guess) to find actual L.												
28	Table 6												
29	Linear Theory	U	H ₁	H ₂	Wave Period, T	Depth	L-guess	L (actual)	H	R	R ₁	R ₂	Wave Runup + Setup
30		mph	ft	ft	seconds	ft	ft	ft	ft	ft	ft	ft	ft
31		50	1.8	1.87	17.759	17.759	17.759	17.759	17.759	17.759	17.759	17.759	17.759
32	* Although the reservoir does not meet criteria for a deep reservoir (waves depth 1/2L), we will use 2.00 ft wave runup and setup to be conservative.												

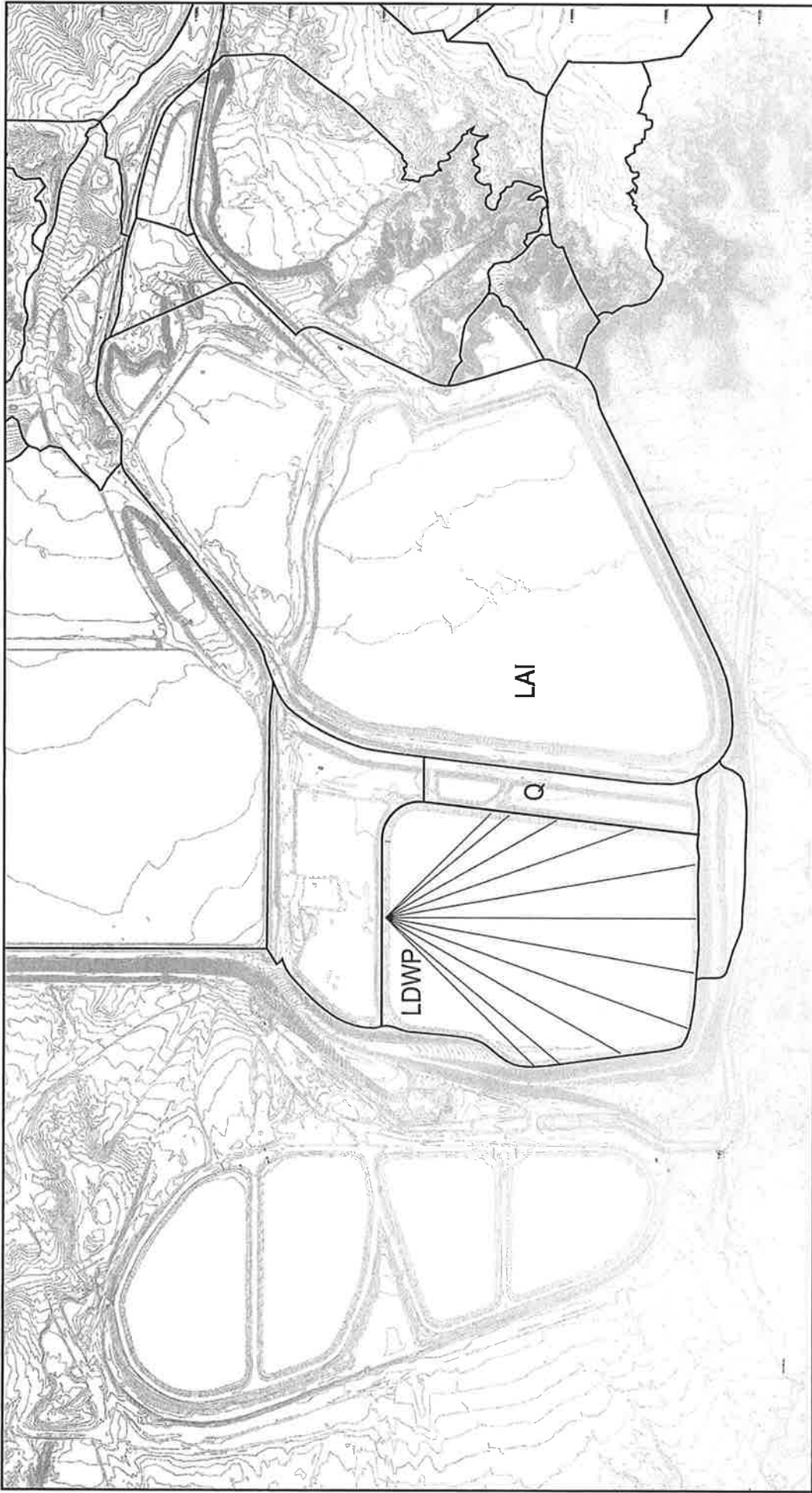

LINED DECANT WATER POND
 FREEBOARD ANALYSIS
 FOUR CORNERS POWER PLANT

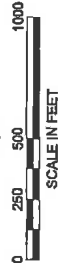

Figure 1

P:\WRES\Arizona_Public_Service\23445725_APS_LAL_5268_Raise_Design\CADD\FIGURES\ LDWP_Fetch.dwg -- Sep 30, 2010 1:25pm

aecom.com